



[High Quality Original Manuals for you](#)

[Visit us on the Internet](#)
sales@manuals-for-you.com

Strata[®] ***DK***

Digital Business Telephone Solutions

General Description

DK14

Software Release 3.1

DK40i

Software Release 4.1

DK424

**Software Release 4.1
and ACD**

Strata DK

General End User Information

The Strata DK Digital Business Telephone System is registered in accordance with the provisions of Part 68 of the Federal Communications Commission's Rules and Regulations.

FCC Requirements

Means of Connection: The Federal Communications Commission (FCC) has established rules which permit the Strata DK system to be connected directly to the telephone network. Connection points are provided by the telephone company—connections for this type of customer-provided equipment will not be provided on coin lines. Connections to party lines are subject to state tariffs.

Incidence of Harm: If the system is malfunctioning, it may also be disrupting the telephone network. The system should be disconnected until the problem can be determined and repaired. If this is not done, the telephone company may temporarily disconnect service. If possible, they will notify you in advance, but, if advance notice is not practical, you will be notified as soon as possible. You will be informed of your right to file a complaint with the FCC.

Service or Repair: For service or repair, contact your local Toshiba telecommunications distributor. To obtain the nearest Toshiba telecommunications distributor in your area, call Toshiba America Information Systems, Inc., Telecommunication Systems Division in Irvine, CA (949) 583-3700.

Telephone Network Compatibility: The telephone company may make changes in its facilities, equipment, operations, and procedures. If such changes affect the compatibility or use of the Strata DK system, the telephone company will notify you in advance to give you an opportunity to maintain uninterrupted service.

Notification of Telephone Company: Before connecting a Strata DK system to the telephone network, the telephone company may request the following:

1. Your telephone number.
2. FCC registration number:
 - ♦ Strata DK may be configured as a Key or Hybrid telephone system. The appropriate configuration for your system is dependent upon your operation of the system.
 - ♦ If the operation of your system is only manual selection of outgoing lines, it may be registered as a Key telephone system.
 - ♦ If your operation requires automatic selection of outgoing lines, such as dial access, Least Cost Routing, Pooled Line Buttons, etc., the system must be registered as a Hybrid telephone system. In addition to the above, certain features (tie Lines, Off-premises Stations, etc.) may also require Hybrid telephone system registration in some areas.
 - ♦ If you are unsure of your type of operation and/or the appropriate FCC registration number, contact your local Toshiba telecommunications distributor for assistance.
DK14 and DK40i
Key system: **CJ6MLA-74479-KF-E**
Hybrid: **CJ6MLA-74478-MF-E**
DK424
Hybrid: **CJ69XA-10243-MF-E**
Key system: **CJ69XA-10242-KF-E**
PBX: **CJCHN-22757-PF-E**
3. Ringer equivalence number: 0.3B. The ringer equivalence number (REN) is useful to determine the quantity of devices which you may connect to your telephone line and still have all of those devices ring when your number is called. In most areas, but not all, the sum of the RENs of all devices connected to one line should not exceed five (5.0B). To be certain of the number of devices you may connect to your line, as determined by the REN, you should contact your local telephone company to ascertain the maximum REN for your calling area.

4. Network connection information USOC jack required: RJ1CX, RJ2EX, RJ2GX, RJ48C, RJ48X, RJ11, RJ14C, RJ21X (see Network Requirements in this document). Items 2, 3 and 4 are also indicated on the equipment label.

Radio Frequency Interference

Warning: This equipment generates, uses, and can radiate radio frequency energy and if not installed and used in accordance with the manufacturer's instruction manual, may cause interference to radio communications. It has been tested and found to comply with the limits for a Class A computing device pursuant to Subpart J of Part 15 of FCC Rules, which are designed to provide reasonable protection against such interference when operated in a commercial environment. Operation of this equipment in a residential area is likely to cause interference, in which case, the user, at his/her own expense, will be required to take whatever measures may be required to correct the interference.

This system is listed with Underwriters Laboratory.

UL Requirement: If wiring from any telephone exits the building or is subject to lightning or other electrical surges, then secondary protection is required. Secondary protection is also required on DID, OPS, and tie lines. (Additional information is provided in this manual.)



Important Notice — Music-On-Hold

In accordance with U.S. Copyright Law, a license may be required from the American Society of Composers, Authors and Publishers, or other similar organization, if radio or TV broadcasts are transmitted through the music-on-hold feature of this telecommunication system. Toshiba America Information Systems, Inc., hereby disclaims any liability arising out of the failure to obtain such a license.

CP01, Issue 8, Part I Section 14.1

Notice: The Industry Canada label identifies certified equipment. This certification means that the equipment meets certain telecommunications network protective, operational and safety requirements as prescribed in the appropriate Terminal Equipment Technical Requirements document(s). The Department does not guarantee the Equipment will operate to the user's satisfaction.

Before installing this equipment, users should ensure that it is permissible to be connected to the facilities of the local telecommunications company. The equipment must also be installed using an acceptable method of connection. The customer should be aware that compliance with the above conditions may not prevent degradation of service in some situations.

Repairs to certified equipment should be coordinated by a representative designated by the supplier. Any repairs or alterations made by the user to this equipment, or equipment malfunctions, may give the telecommunications company cause to request the user to disconnect the equipment.

Users should ensure for their own protection that the electrical ground connections of the power utility, telephone lines and internal metallic water pipe system, if present, are connected together. This precaution may be particularly important in rural areas.

CAUTION! Users should not attempt to make such connections themselves, but should contact the appropriate electric inspection authority, or electrician, as appropriate.

CP01, Issue 8, Part I Section 14.2

Notice: The Ringer Equivalence Number (REN) assigned to each terminal device provides an indication of the maximum number of terminals allowed to be connected to a telephone interface. The terminal on an interface may consist of any combination of devices subject only to the requirement that the sum of the Ringer Equivalence Numbers of all the Devices does not exceed 5.

Publication Information

Toshiba America Information Systems, Inc., Telecommunication Systems Division, reserves the right, without prior notice, to revise this information publication for any reason, including, but not limited to, utilization of new advances in the state of technical arts or to simply change the design of this document.

Further, Toshiba America Information Systems, Inc., Telecommunication Systems Division, also reserves the right, without prior notice, to make such changes in equipment design or components as engineering or manufacturing methods may warrant.

DKA-GD-GNDES-VE
4010445

Version E, May 1999
Version D, August 1998
Version C, March 1998
Version B, October 1997
Version A.1, May 1997
Version A, March 1997

© Copyright 1999 Toshiba America Information Systems, Inc. Telecommunication Systems Division

All rights reserved. No part of this manual, covered by the copyrights hereon, may be reproduced in any form or by any means—graphic, electronic, or mechanical, including recording, taping, photocopying, or information retrieval systems—without express written permission of the publisher of this material.

Strata AirLink and Call Center Viewer are trademarks of Toshiba America Information Systems, Inc. Strategy is a registered trademark of Toshiba America Information Systems, Inc. Strata is a registered trademark of Toshiba Corporation.

Trademarks, registered trademarks, and service marks are the property of their respective owners.

Contents

Introduction

Organization.....	ix
Conventions.....	x
Related Documents/Media.....	x

Chapter 1 – Strata DK14

KSU Architecture.....	2
Digital Telephone/Central Office (CO) Line Circuits.....	2
Optional Printed Circuit Boards.....	3
Central Office Line/Digital Telephone Interface Unit (QCDU2).....	3
Standard Telephone Interface Unit (QSTU2).....	3
DTMF Receiver/ABR Tone Detector Unit (QRCU3).....	3
Auto Attendant Feature Key (QKYS1).....	3
Serial Interface Board (WSIU1).....	3
Power Supply.....	4
Reserve Power.....	4
Power Failure Interface.....	4
Music-on-Hold (MOH) Interface.....	5
Paging Interface.....	5
Flexible Relay Contacts.....	5
Maximum Line/Station Configurations.....	5
Network Requirements.....	5
Functional Block Diagram.....	6
System Technology.....	7
Pulse Code Modulation.....	7
Custom Electronic Circuitry.....	7
Stored Program Control.....	7
Microprocessors.....	7
Maintenance and Programming.....	8
DKAdmin/DKBackup.....	8

Chapter 2 – Strata DK40i

Station and CO Lines.....	9
Peripherals.....	10
Base KSU Architecture.....	11
Digital Telephone Circuits.....	11
Central Office (CO) Line Circuits (TCOU/TDDU/TBSU).....	11
ISDN BRI S/T Circuits (TBSU).....	12
Caller ID (TCIU2).....	12
Standard Telephone Interface Unit (KSTU2).....	12

DTMF/ABR Tone Detection Receiver (K5RCU and K5RCU2)	12
Auto Attendant Feature Key (KKYS)	12
SMDR, SMDI, and Maintenance DKAdmin/Modem (TTY) Interface (TSIU).....	12
Power Supply.....	13
Power Failure Interface	14
Music-on-Hold Interface	14
Expansion KSU Architecture.....	14
Typical Line Configurations	15
DK40i Line and Station Capacity.....	15
Network Requirements.....	15
Functional Block Diagram	16
System Technology.....	17
Pulse Code Modulation	17
Custom Electronic Circuitry.....	17
Stored Program Control.....	17
Microprocessors.....	17
Maintenance and Programming	17
DKAdmin/DKBackup	17
Strata AirLink Wireless System.....	18

Chapter 3 – Strata DK424

Architecture.....	19
Base and Expansion Cabinets.....	19
Expansion and Configuration	20
Expansion Cabinets	20
Printed Circuit Boards (PCBs)	21
Maximum Line/Station Capacities.....	22
Power Requirements	26
Floor Mount Hardware.....	28
Functional Block Diagrams.....	29
System Technology.....	32
Pulse Code Modulation	32
Custom Electronic Circuitry.....	32
Stored Program Control.....	32
Microprocessors.....	32
Maintenance and Programming	32
DKAdmin/DKBackup	32
Strata AirLink Wireless System.....	33

Chapter 4 – Universal Slot PCBs

Station PCBs	35
Digital Telephone Interface Unit (PDKU2)	35
Digital/Standard Telephone Interface Unit (RDSU)	35
Strata AirLink Wireless Interface Unit (RWIU)	36
CO Line/Digital Telephone Interface Unit (KCDU) (DK40i only)	36
Electronic Telephone Interface Unit (PEKU)	36
Standard/Electronic Telephone Interface Unit (PESU).....	36
Standard Telephone Interface Unit (RSTU2).....	36

Console PCBs.....	37
Attendant Console Interface Unit (RATU, DK424 only).....	37
CO Line PCBs.....	37
Caller ID Interface Unit (RCIU2).....	37
Loop Start CO Line Interface Unit (RCOU)	38
Ground/Loop Start Interface CO Line Interface Unit (RGLU2).....	38
Direct Inward Dialing Interface Unit (RDDU).....	38
Tie Line Unit (REMU)	38
T1/DS-1 Interface Unit (RDTU2) (DK424 only).....	38
ISDN Primary Rate Interface Unit (RPTU) (DK424 only).....	39
ISDN S/T-type Basic Rate Interface Unit (RBSU)	39
ISDN U-type Basic Rate Interface Unit (RBUU) (DK424 only).....	40
Enhanced 911 CAMA Trunk Interface Unit (RMCU/RCMS) (DK424 only).....	40
Summary of PCBs and Subassemblies	40
Option Interface PCBs	43
Option Interface Unit (PIOU).....	43
Simplified Option Interface Unit (PIOUS).....	44
External Page Interface Unit (PEPU)	44
Single Serial Interface Unit (RSSU).....	45
Serial Interface Unit (RSIU, DK424 only).....	46

Chapter 5 – Stations and Peripherals

Digital Telephones	48
Liquid Crystal Display (LCD) Telephones	50
Speakerphones.....	51
Peripherals.....	52
Digital Telephone Upgrade Options	53
Digital Add-on Module (DADM).....	53
Integrated PC Interface (RPCI-DI).....	53
Headset/Loud Ringing Bell Interface (HHEU)	53
Speaker Off-hook Call Announce (DVSU).....	54
Stand-alone Data Interface Unit (PDIU-DS)	54
Cordless Digital Telephone (DKT2004-CT)	54
Strata AirLink Wireless Handset	55
Features.....	55
PC Digital Telephone (PC-DKT).....	56
PC Attendant Console (DK-PCATT).....	57
Direct Station Selection (DSS) Console	58
Door Phone (MDFB).....	58
Door Phone and Lock Control Unit (DDCB)	59
External Speaker (HESB)	59
Toshiba Strategy and Strategy DK Processing	59
Cabling and Connectors	60
Station and Peripheral Specifications.....	60

Chapter 6 – Features

System Features	61
Abandoned Call Numbers	61
Account Codes (Forced/Voluntary/Verified).....	61

Alarm Sensor (DK40i and DK424 only).....	62
Alternate Answer Point	62
Amplified Conference Interface	62
Auto Attendant (Built-in)	62
Automatic Call Distribution (ACD) (DK424 only).....	62
Automatic Number Identification (ANI).....	63
Automatic Release from Hold	64
Background Music (BGM).....	64
Caller ID	65
Centrex/PBX Compatible.....	65
Centrex Ringing Repeat.....	65
Computer Telephony Integration (CTI)	66
Conferencing	67
Credit Card Calling.....	67
Data Switching	67
Day/Night Modes	67
Delayed Ringing.....	67
Dialed Number Identification Service (DNIS) (DK40i and DK424 only).....	68
Direct Inward Dialing (DID) Lines (DK40i and DK424 only)	68
Direct Inward System Access (DISA).....	69
Distinctive CO Line/Directory Number Ringing	69
Door Lock Control.....	69
Door Phones (MDFB)	69
DTMF Back Tone.....	70
DTMF and Dial Pulse CO Line Compatible	70
DTMF Signal Time (80/160 milliseconds)	70
Emergency Ringdown	70
Enhanced 911 (E911) Service	70
External Page Zones	71
Flexible Button Assignment	71
Flexible Directory Numbers	71
Group Paging.....	71
Handsfree Directory Number Paths.....	72
Hospitality Management Information System (HMIS).....	72
Hotline Service	72
Integrated Services Digital Network (ISDN)	73
Least Cost Routing (LCR).....	75
Line Groups	76
Line Queuing	76
Live System Programming	76
Memory Protection	76
Message Waiting	76
Multiple Directory Numbers	76
Multiple FCC Registration	78
Music-on-hold (MOH)	78
Night Ringing Over External Page.....	78
Night Ringing Over Selected Page Zones	78
Non-blocking Talk Paths.....	78
Off-premises Station.....	78
Outgoing Call Restriction.....	79

Pooled CO Line Button	79
Power Failure Transfer	79
Privacy/Non-privacy Calling	79
Relay Service	79
Remote Administration/Maintenance	80
Reserve Power	80
Simplified Message Desk Interface (SMDI)	80
Speed Dial	81
Station Hunting	81
Station Message Detail Recording (SMDR)	82
Station Relocation	82
StrataControl (DK40i and DK424 only)	82
System Programming through a Station	83
System Program Administration Software (DKAdmin)	83
T1 Interface (DK424 only)	83
Tandem CO Line Connections	83
Tenant Service	84
Tie Lines	84
Toll Restriction Override by System Speed Dial	85
Traveling Class of Service	85
Unrestricted Call Transfer to Directory Numbers	85
Voice First or Tone Signaling	85
Voice Mail Integration	85
Station Features	90
Account Code Button	90
Add-on Module (DADM)	90
Alert Signal Button	90
Automatic Busy Redial (ABR)	90
Automatic Callback (ACB)	90
Automatic Hold	90
Automatic Line Selection	91
Background Music (BGM) with Station Control	91
Busy Override	91
Busy Station Transfer/Busy Station Ringing	91
Call Forwarding	91
Call Park Orbits	92
Call Pickup	93
Call Pickup Groups	93
Call Transfer with Camp-on	93
Call Transfer Immediate	93
Call Transfer Music or Ringing Option	94
Call Transfer Recall	94
Centrex/PBX Features	94
Conferencing	94
Continuous Dual-tone Multi-frequency (DTMF) Tone	94
Data Call Button	94
Direct Station Selection (DSS) Buttons	94
Direct Station Selection (DSS) Console Features	94
Directory Number [DN] Buttons	95
DISA Security Code Revision	95

Distinctive LED Color and Flash Indications.....	95
Distinctive Station Ringing	95
Do Not Disturb (DND)	95
Do Not Disturb (DND) Override.....	95
DP/DTMF Mode Change	95
Exclusive Hold	95
Executive Override	96
Feature Prompting with Soft Keys	96
Flash Button.....	96
Handsfree Answerback.....	96
Hearing Aid Compatible.....	96
Liquid Crystal Display (LCD) Features	96
Microphone Cut-off Button	96
Modem Button	96
Modular Handset and Line Cords.....	96
Modular Headset.....	97
Off-hook Call Announce (OCA)	97
On-hook Dialing	97
Personal Computer Interface (RPCI-DI)	98
Pooled Line Buttons	98
Private CO Lines	98
Push-button Dialing	98
Release Button	98
Release/Answer Button	98
Remote Retrieval of Held/Parked Calls.....	98
Repeat Last Number Dialed	98
Ringling Line Preference.....	98
Saved Number Redial	98
Speed Dial Buttons	99
Telephone Application Programming Interface (TAPI) Compatibility	99
Timed Reminders	99
Toll Restriction Override Code Revision	99
User Programmable Feature Buttons.....	99
PC Attendant Console Features	102
Answer Button.....	102
Answer Priority.....	102
Answer Prompting.....	102
Attendant Conference Setup.....	102
Auto Day/Night Mode Switching.....	102
Auto Dialing	102
Busy Lamp Field (BLF) Display	102
Call Waiting Count.....	103
Color CRT Display	103
Dial “O” For Attendant.....	103
Dial Outside Number For Station User	103
Direct Station Selection (DSS)	103
Directory Display and Dialing.....	103
DTMF Signaling from Dial Pad	103
Emergency Calls.....	103
Emergency Page	103

Feature On-Line Help	104
Feature Prompting with Soft Keys	104
Flexible Programmable Buttons	104
Headset Operation	104
Hold Button	104
Hold Timer Display	104
Incoming Call Identification.....	104
Incoming Call Statistics.....	104
Interposition Call Transfer.....	105
Join Button.....	105
Keyboard or Mouse Operation	105
Load Sharing.....	105
Loop Hold Display	105
Message Center.....	105
Multi-tasking	105
Name or Number Dialing	106
Overflow	106
Override	106
Position Busy Mode.....	106
Release Button	106
Speed Dial Calling.....	106
Split/Switch Button.....	107
Three-way Calling	107
Through Dialing	107
Transfer Direct to Voice Mail	107
Trunk Group Busy Indication.....	107
Trunk Group Control.....	107
Volume Control	107
Windows PC Operation.....	107
Appendix	109
Network Requirements.....	110
Customer-supplied Peripherals and Interfaces.....	111
Station Specifications.....	112
Glossary	117
Index	121

Introduction

This General Description provides an overview of the Strata DK telephone systems, associated hardware, system and station features. These systems include:

- ♦ Strata DK14
- ♦ Strata DK40i
- ♦ Strata DK424

Organization

This document is divided into the following major topics:

- ♦ **Chapter 1 – Strata DK14** presents the Strata DK14 system overall and covers the basics of: capacities, system expansion and configuration, power requirements, technology, and maintenance.
- ♦ **Chapter 2 – Strata DK40i** presents the Strata DK40i system overall and covers the basics of capacities, system expansion and configuration, power requirements, technology, and maintenance.
- ♦ **Chapter 3 – Strata DK424** presents the Strata DK424 system overall and covers the basics of capacities, system expansion and configuration, technology, power requirements, maintenance, and programming.
- ♦ **Chapter 4 – Universal Slot PCBs** provides information about Printed Circuit Boards (PCBs) that can be installed in the universal slots of the Strata DK systems.
- ♦ **Chapter 5 – Stations and Peripherals** describes the most recent Toshiba-proprietary stations and peripherals, customer-supplied peripherals, as well as cabling and connectors. Includes information on system tones and data interface specifications.
- ♦ **Chapter 6 – Features** describes the features which are available system-wide, as well as station features and shows the types of stations on which they are available. This chapter also describes the Strata DK PC Attendant Console features.

Conventions

Conventions	Description
Note	Elaborates specific items or references other information. Within some tables, general notes apply to the entire table and numbered notes apply to specific items.
Important!	<i>Calls attention to important instructions or information.</i>
[DN]	Represents any Directory Number button, also known as an extension or intercom number.
[PDN]	Represents any Primary Directory Number button (the extension number for the telephone).
[SDN]	Represents any Secondary appearance of a PDN. A PDN which appears on another telephone is considered an SDN.
[PhDN]	Represents any Phantom Directory Number button (an additional DN).
[]	Brackets indicate a variable button. Example: [DN] represents the actual Directory Number, such as [301].
\$ UDC#/%ROG	Represents telephone buttons.
Courier	Shows a computer keyboard entry or screen display.
+	shows a multiple PC keyboard or phone button entry. Entries without spaces between them show a simultaneous entry. Example: Delete+Enter . Entries with spaces between them show a sequential entry. Example: & + 8 .
Tilde (~)	Means “through.” Example: 350 ~ 640 Hz frequency range.
See Figure 10	Grey words within the printed text denote cross-references. In the electronic version of this document (Strata DK Library CD-ROM or FYI Internet download), cross-references appear in blue hypertext.

Related Documents/Media

The following documents and CD-ROMS can be used to reference further information about the Strata DK systems.

- ♦ **Digital Telephone User Guide** provides all the procedures necessary to operate Toshiba-proprietary digital telephones, including Liquid Crystal Display (LCD) features. It also includes instructions for using the add-on module/DSS console.
- ♦ **Digital Telephone Quick Reference Guide** provides a quick reference for frequently-used digital telephone features.
- ♦ **Digital Single Line Telephone User Guide** provides all the procedures necessary to operate Toshiba-proprietary digital single line telephones.

- † **Electronic Telephone User Guide** explains all the procedures necessary to operate Toshiba-proprietary electronic telephones, including all LCD features. Does not apply to the Strata DK14 system. It also includes instructions for using the electronic DSS console.
- † **Electronic Telephone Quick Reference Guide** provides a quick reference for frequently-used electronic telephone features. Does not apply to the Strata DK14 system.
- † **Standard Telephone User Guide** explains all the procedures necessary to operate rotary dial and push-button standard telephones.
- † **Strata AirLink External Wireless Handset User Guide** shows how to use the wireless handset configured to Strata DK telephone system Strata DK telephone system and many non-Toshiba systems.
- † **Strata AirLink External Wireless Quick Reference Guide** contains instructions for operation of commonly used Strata AirLink External Wireless Handset features.
- † **Strata AirLink Integrated Wireless Handset User Guide** shows how to use the wireless handset configured to digital ports of the Strata DK telephone system.
- † **Strata AirLink Integrated Wireless Quick Reference Guide** contains instructions for operation of commonly used Strata AirLink Integrated Wireless Handset features.
- † **System Administrator Guide** gives instructions for the System Administrator to manage the system. Contains instructions for Station Relocation, System Speed Dial, and other features only activated by the System Administrator.
- † **PC/Data Interface User Guide** explains all the procedures necessary to operate stand-alone data interface units in the data mode for printer sharing and modem pooling. Also covers connection to a PC with a Telephone Application Programming Interface (TAPI).
- † **Cordless Telephone User Guide** provides instructions on using the DKT2004-CT cordless digital telephone as a single unit or in conjunction with a digital telephone.
- † **PC-DKT User Guide** provides installation and operation information for the Personal Computer Digital Key Telephone system.
- † **Strata DK Feature Description Manual** describes each feature associated with the Strata DK424, DK40i and DK14. Also provides descriptions of compatible Toshiba-proprietary telephones and peripherals.
- † **Keyprint 2000 User Guide** provides instructions for the Keyprint 2000 software printing package which allows you to print and store custom button label keystrips for Strata DK 2000-series 10-button or 20-button digital telephones, 20-button add-on modules, and 60-button digital DSS consoles.
- † **Strata DK Programming Manual** provides all instructions necessary to program the system and system record sheets, including ACD.
- † **Strata DK Installation & Maintenance Manual** provides installation instructions for configuring and installing the Strata DK14, DK40i and DK424. It also includes T1/DS-1 interface installation and configuration instructions, as well as fault finding flowcharts to troubleshoot the systems. An ACD Section provides instructions for installing ACD into the Strata DK424.
- † **Strata AirLink External Wireless System Installation Guide** provides step-by-step hardware and software installation instructions. It includes examples of system configurations, information on performing a site survey, and troubleshooting techniques.
- † **Hospitality Management Information System (HMIS) General Description** provides an overall view of the system's hardware, software, applications and features. The HMIS is a PC-

- based solution, designed to meet the specific operational needs of small- to medium-sized hotel/motels and includes both the PC and software.
- ✦ **Hospitality Management Information System (HMIS) User Guide** describes the product's many software features and gives step-by-step instructions for using them.
 - ✦ **Strata DK Library CD-ROM** enables you to view, print, navigate and search publications for Strata DK14, DK40 and DK424 digital business telephone systems. It also includes Strata DK424 ACD Documentation, including the *Strata DK424 Call Center Solutions General Description*, *ACD Agent Guide*, *ACD Supervisor's Guide*. ACD Installation and Programming instructions are included in the *Strata DK Installation and Maintenance Manual* and *Programming Manual*.
 - ✦ **Strata DK HMIS CD-ROM** contains a copy of all HMIS documentation/bulletins and enables you to view, print, navigate and search publications.
 - ✦ **StrataControl CD-ROM** contains the StrataControl software, that enables viewing, downloading, editing, and uploading Strata DK programmed data on a PC. This software also provides a method of creating custom lists and user guides based on information from the Strata DK system. The CD-ROM contains the *StrataControl User Guide*.
 - ✦ **DKQuote CD-ROM** contains the DKQuote application and the DKQuote User Guide, that shows how to use this interactive software to assist you with Strata DK Systems configuration and pricing worksheets.
 - ✦ **DKAdmin/DKBackup CD-ROM** includes the programs that let you custom program and/or update the Strata DK14/DK40/DK424 with a user-friendly PC display. The CD-ROM also contains the *DKAdmin/DKBackup User Guide*, that explains how to use the DKAdmin/DKBackup interactive software applications. The current version does not support DK40i.

The following documentation and media applies to the Strata DK424 system only.

- ✦ **Strata DK424 Call Center Solutions General Description** provides a system overview, including hardware and feature information. Highlights the technology employed in operating the ACD Strata DK424 system.
- ✦ **ACD Agent Guide** provides step-by-step procedures for using ACD agent features.
- ✦ **ACD Supervisor Guide** provides instruction on how to use the ACD supervisor features.
- ✦ **Insight DK CD-ROM** which includes training, all Insight DK documentation, Insight DK software and the upgrade to Insight DK Plus, and Demo software.
- ✦ **Insight DK Installation Guide** explains how to set up the network, install the server software, install clients and explains how the data files are organized.
- ✦ **Insight DK Supervisor Guide** provides instructions for using the Strata DK Insight and Insight DK Plus MIS for the Supervisor of a call center. Instructions for creating and using Real Time Displays, Reports, Alarms, and Wallboards are also included.
- ✦ **Insight DK inView Quick Reference Guide** provides instructions for viewing and customizing the on-screen wallboard and displays of the real time call center data.
- ✦ **PC Attendant Console User Guide** explains how to operate the PC Attendant Console.
- ✦ **PC Attendant Console Quick Reference Guide** provides a quick reference for frequently-used PC Attendant Console features.
- ✦ **Call Center Viewer User Guide** describes how to install and operate the Call Center Viewer application on a PC. It explains how to view and customize ACD group and agent status data.
- ✦ **Software MIS (SMIS) Supervisor Manual** provides descriptions, examples, and instructions on using the Software MIS application.

This chapter provides an overview of the Strata DK14 System and its capacities.

The Strata DK14 Base Key Service Unit (KSU) is a compact system that provides many of the features offered by much larger systems. The Strata DK14 KSU is designed for convenient wall-mounting and occupies very little space (see Figure 1 and Table 1).

At maximum configuration, the Strata DK14 provides up to 10 station ports, that can be used for up to 8 digital telephones (including the cordless telephone), up to four Central Office (CO) lines can be accommodated, and two standard telephone devices.

The Strata DK14 can be upgraded with these optional peripherals:

- ◆ Music-on-hold (MOH) source
- ◆ Background Music (BGM) source
- ◆ Night bell
- ◆ Amplifier/speaker for external page

Also, any two of the following optional RS-232 interfaces can be added as needed:

- ◆ Caller ID (CLID)
- ◆ Station Message Detail Reporting (SMDR)
- ◆ Simplified Message Desk Interface (SMDI) for Voice Mail
- ◆ DKAdmin (TTY) Interface

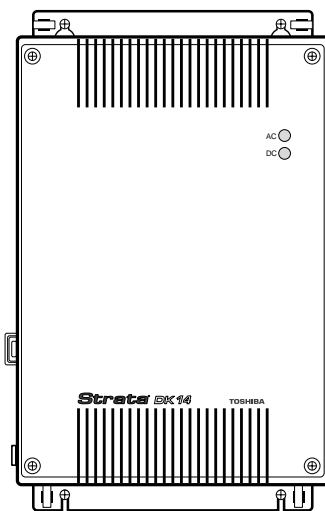

Figure 1 Base Key Service Unit (KSU)

Table 1 KSU Specifications

Unit	Weight	Height	Width	Depth
Key Service Base Unit	5.7 lbs. (2.59 kg)	16.4 inches (416 mm)	10.0 inches (254 mm)	3.0 inches (76 mm)

KSU Architecture

The Strata DK14 KSU contains the main processor, operating software, circuitry and the following components (see Figure 2).

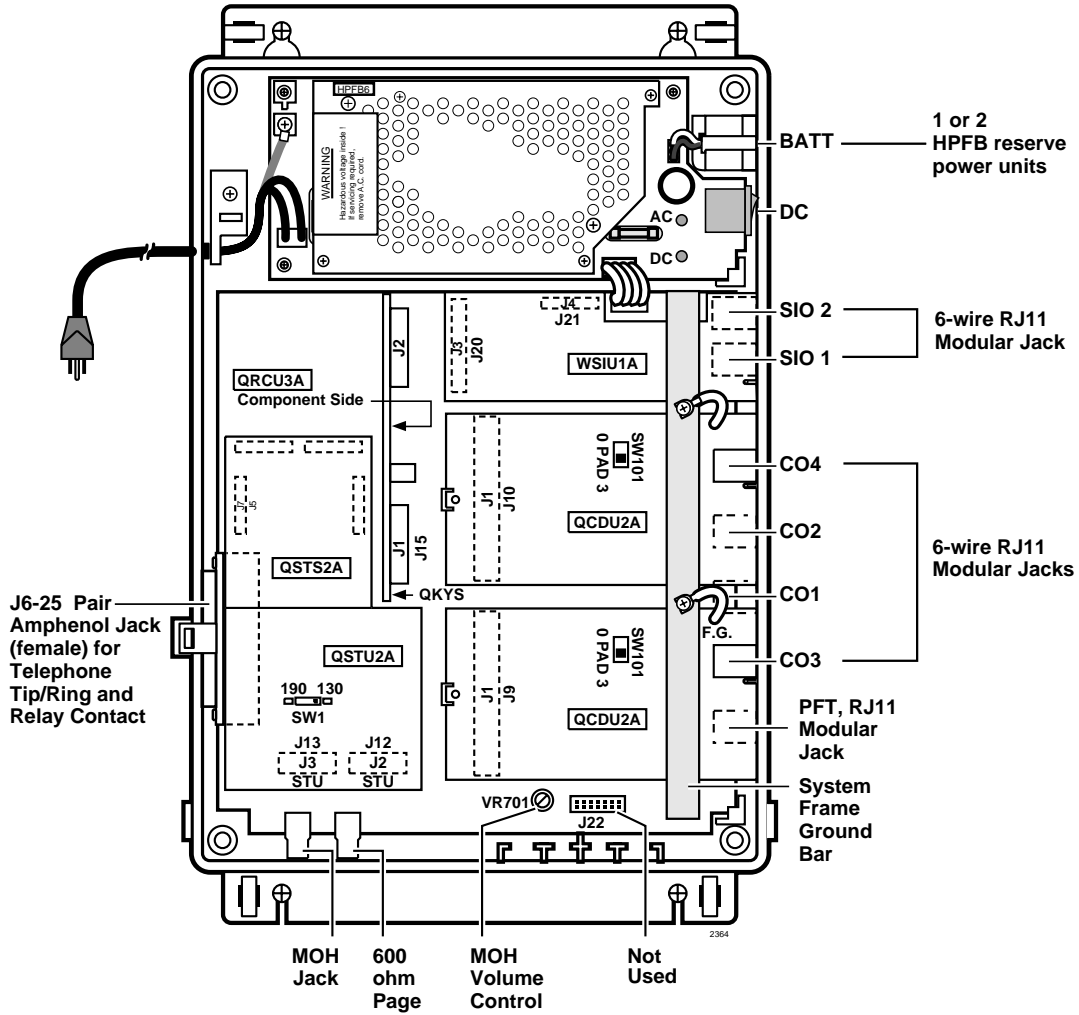

Figure 2 KSU Interior

Digital Telephone/Central Office (CO) Line Circuits

The main PCB (WMAU) has four integrated circuits that can connect to digital corded and/or cordless telephones, stand-alone data interface units (PDIU-DSs), and digital door phone/lock control units (DDCB). Each of the digital telephones can support a PC Data Interface Unit (RPCI-DI) or up to two Add-on Modules (DADMs). It does not support a DDSS console.

Two circuits for loop start CO lines are built into the main PCB. Each line can be programmed for Dual-tone Multi-frequency (DTMF) or dial pulse signaling. It includes a switch to control potential excess volume from a nearby private branch exchange (PBX) or CO. Built-in gas tubes help protect each circuit from lightning. Each line supports Caller ID when optional equipment is added.

Optional Printed Circuit Boards

Central Office Line/Digital Telephone Interface Unit (QCDU2)

The QCDU2 provides one loop start CO line circuit and two digital telephone circuits. It interfaces with digital corded and/or cordless telephones, RPCI-DIs, ADMs connected to the corded telephones and PDIU-DSs, and door phones. The DK14 supports up to six door phones. It does not support a DDSS console. Up to two QCDU2 PCBs can be added to the DK14. Each line supports Caller ID when optional equipment is added.

Standard Telephone Interface Unit (QSTU2)

The QSTU2 provides two standard telephone circuits for two-wire devices such as standard telephones, Auto Attendant devices, alternate BGM source connection, voice mail machines, and facsimile machines.

DTMF Receiver/ABR Tone Detector Unit (QRCU3)

The QRCU3 enables the Strata DK14 to recognize Dual-Tone Multi-Frequency (DTMF) tones generated by a standard telephone or any other device connected to a QSTU3 standard telephone circuit. It is also required for Direct Inward System Access (DISA) calls and built-in Auto Attendant. The QRCU3 enables busy tone detection for Automatic Busy Redial.

Auto Attendant Feature Key (QKYS1)

The QKYS1 plugs into the QRCU3 option PCB to support built-in Auto Attendant.

Serial Interface Board (WSIU1)

The WSIU1 provides two serial interface ports for up to two of the following devices:

- ♦ Caller ID interface box
- ♦ SMDR Call Accounting device
- ♦ SMDI Voice Mail Interface
- ♦ PC with DKAdmin or external modem

Power Supply

The power supply generates +5VDC and +24VDC for the entire system. [Table 2](#) for a summary of electrical/environmental characteristics.

Table 2 Summary of Electrical/Environmental Characteristics

DK14 Primary Power	
Input AC	115VAC \pm 10VAC
AC frequency	50/60 Hz
Power	DK14 - 46 watts maximum
AC input current	<0.7 amps. max
Environmental Specifications	
Operating temperature	32~104° F (0 ~40° C)
Operating humidity	20~80% relative humidity without condensation
Storage temperature	-4~158° F (-20~70° C)
Power Supply	
DC voltage output specification	+24VDC (+26.3~-27.8VDC) +5VDC (+4.5~+5.5VDC)
QSTU2	
Ring voltage	Square wave output with high/low option jumper: Low position 130 \pm 20VDC peak-to-peak (no-load) High position, 190 \pm 25VDC peak-to-peak (no-load)
Ringing capability	2 ringers maximum per circuit, high or low position

Reserve Power

One or two optional Reserve Power Battery and Chargers (HPFBs) can be connected to the Strata DK14 power supply to maintain normal operation during a power failure. The estimated battery time for one or two HPFBs is shown below.

DK14 (fully-loaded system)	Estimated Battery Time (hours)
One HPFB	0.5~1.0
Two HPFBs	1.0~2.0

Notes

- Reserve power time varies with system call traffic.
- AC power must be available when HPFB is first installed.
- HPFB recharge time is 48 hours per HPFB.

Power Failure Interface

The Strata DK14 KSU provides an interface for a dedicated backup standard telephone during an AC input power failure. If the system AC input power fails, the backup telephone will automatically connect to the CO1 line. This feature is independent of the HPFB.

Music-on-Hold (MOH) Interface

Customers can connect their own MOH source to this interface. The source can also feed external page speakers and telephone speakers with Background Music (BGM).

Paging Interface

This 600-ohm interface can support a Toshiba External Speaker (HESB) or a customer-supplied amplifier and speaker for Paging, Night Ringing over Page, and BGM applications.

Flexible Relay Contacts

A relay contact can be programmed to either mute BGM during a page announcement over external speakers, to operate a device—such as an answering machine or ringing bell—during the Night Mode, or to provide on-off control for a MOH source.

Maximum Line/Station Configurations

The maximum line and station configurations for DK14 are shown in [Table 3](#).

Table 3 CO Lines and Station Ports

DK14 System	CO Line Ports	Digital Ports	Standard Telephone Ports ¹
Basic KSU	2	4	0 or 2
Expanded KSU	3	6	0 or 2
Expanded KSU	4	8	0 or 2

1. Standard telephone ports do not support MW lamps on standard telephones.

Network Requirements

Network requirements of station/line PCBs and interface cards are summarized in [Table 37 on Page 110](#).

Functional Block Diagram

Figure 3 shows the Strata DK14 KSU PCBs and the available lines, stations and peripherals. Basic voltage and cabling information is also included.

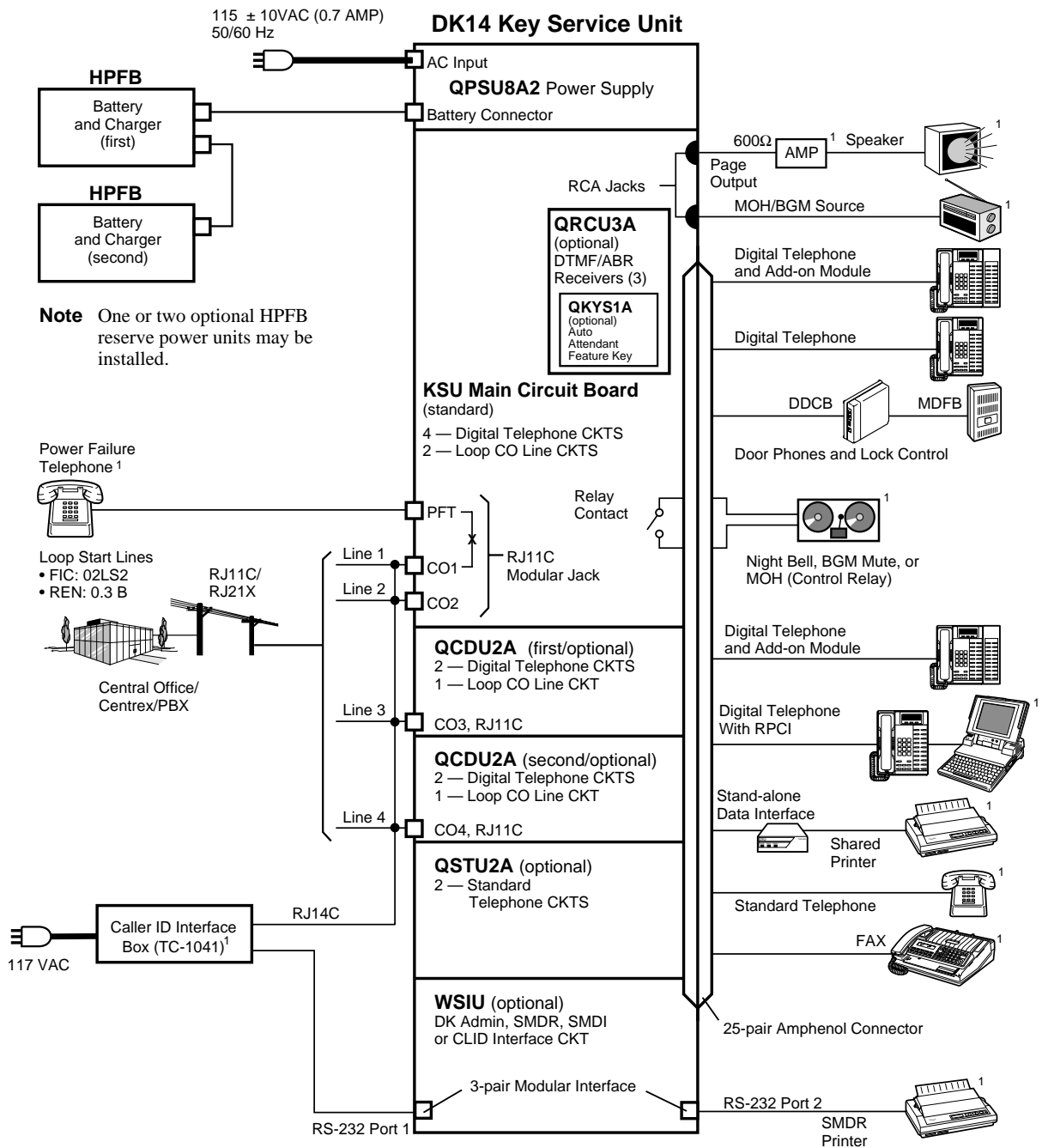

2419

1. Customer-supplied equipment

Figure 3 Functional Block Diagram

System Technology

Pulse Code Modulation

Digital switching talkpaths enable all CO and intercom lines to be accessed simultaneously. Analog-to-digital and digital-to-analog conversion is done by CODECs (coder plus decoder) on station and CO line PCBs.

Custom Electronic Circuitry

Large Scale Integration (LSI) technology makes the Strata DK14 circuit designs simple and efficient. Gate arrays using very large scale integration save vast amounts of space by using the latest technology. More circuitry fits onto smaller PCBs for a more compact system. Widespread use of CMOS circuits minimizes system power requirements.

Stored Program Control

The system uses a 16-bit microprocessor for stored program control. The Strata DK14 System operating software is stored on Read Only Memory (ROM), and individual configuration and custom programming is stored on Random Access Memory (RAM). A lithium battery with a life span of at least six years preserves RAM in the case of a power failure.

Microprocessors

The system's main microprocessor is a 16-bit 68000-type that operates at a clock speed of 8 MHz. In addition, some PCBs use 8-bit, TMP90C840-type local microprocessors that run at 10 MHz. This distributed microprocessing architecture is used system wide.

Maintenance and Programming

Hardware maintenance and repair procedures describe how to quickly locate, remove, and replace defective parts and PCBs. System programming can be performed without taking the system out-of-service.

On-site programming can be executed with any 20-button proprietary LCD telephone or with a DKAdmin PC connected to an optional maintenance port.

Off-site programming with DKAdmin, which can help cut costs and save time, is available through a customer-provided modem connected to the maintenance port.

DKAdmin/DKBackup

Toshiba DKAdmin Release 4.0 software enables customer data (configuration, station, and system options) to be downloaded to a PC and stored on a computer disk. The customer data can be added to, or changed, using the PC independent of the DK System.

The new customer data can then be uploaded to the DK System from the PC, changing customer program options on-site or remotely over telephone lines and/or modems.

The DKBackup software program is also available. The program consists of a small subset of DKAdmin functions which can perform backup, restore and upgrade functions, but cannot edit customer databases.

This chapter provides an overview of the Strata DK40i System and its capacities.

The Strata DK40i Base Key Service Unit (KSU) is a compact system that provides many of the features offered by much larger systems. The KSU is designed for convenient wall-mounting and occupies very little space (see [Figure 4](#) and [Table 4](#).)

Station and CO Lines

The DK40i Base KSU comes equipped with eight digital telephone station circuits. One of three optional PCBs can be added to provide either four loop start or DID lines, or two ISDN BRI S/T circuits. An optional TCIU2 Printed Circuit Board (PCB) can be added to the Base KSU loop start line PCB to provide Caller ID interface. An optional KSTU2 PCB can be added to provide four standard telephone circuits (ports).

Note An optional Expansion KSU can be added to the DK40i to increase the system capacity to 28 station ports and 12 CO lines (see [Figure 5](#)). A maximum of 28 station ports and 12 CO line interfaces are allowed in the system (Base KSU plus Expansion KSU). Base capacity is 12 station ports and 4 CO line interfaces.

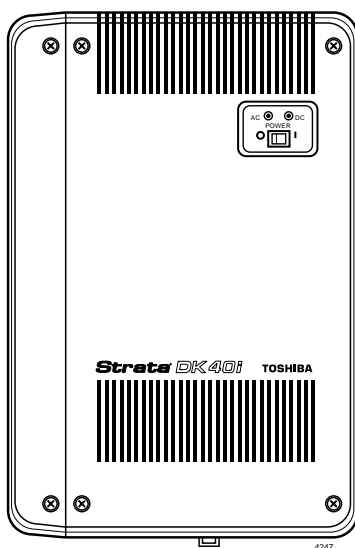

Figure 4 Base Key Service Unit (KSU)

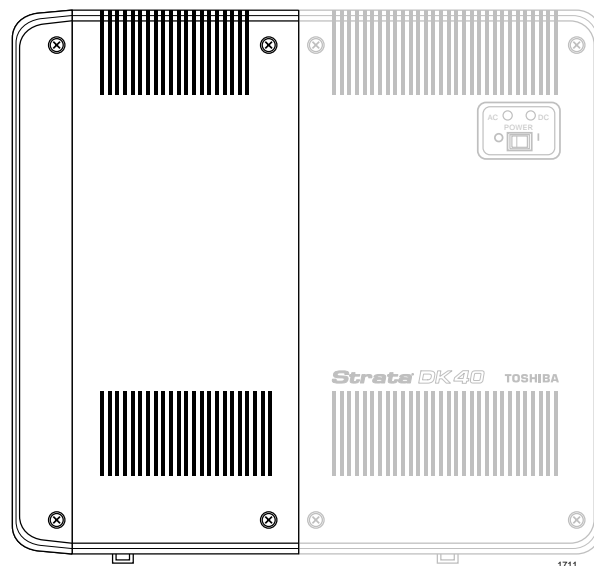

Figure 5 KSU with Expansion Unit

Table 4 KSU and Expansion Unit Specifications

Unit	Weight	Height	Width	Depth
Key Service Base Unit	8.4 lbs. (3.8 kg)	18.0 inches (457 mm)	12.2 inches (310 mm)	3.4 inches (86 mm)
Expansion Unit	1 lb. empty (0.45 kg) 4.3 lbs. full (2.4 kg)	18.0 inches (457 mm)	7.8 inches (198 mm)	3.4 inches (86 mm)

Peripherals

The DK40i Base KSU can support a number of peripherals, which are not considered as stations or lines and do not affect the maximum station and line capacities. The DK40i Base KSU comes standard with built-in interfaces for connecting the following dealer-supplied equipment: an amplifier and speaker for paging and night ringing, Music-on-Hold (MOH) source, reserve power batteries, and emergency standard telephone for system power failure occurrences when using loop start lines in the base cabinet.

A relay contact is also provided to control one of the following peripherals: MOH source, night bell, or page amplifier mute control.

An optional KSTU2 PCB provides an alternate background music source interface. The music plays through Toshiba telephone speakers, as opposed to the external page speakers.

The optional TSIU PCB provides two RS-232 interface ports to connect two of three options: a DKAdmin PC (or external modem for remote maintenance); or VM SMDI; or an SMDR port to connect a call accounting device or printer. An Expansion Unit RS-232 interface PCB is required if all three features are needed.

Base KSU Architecture

The Strata DK40i Base KSU contains the main processor, operating software, circuitry and the following components (see Figure 6).

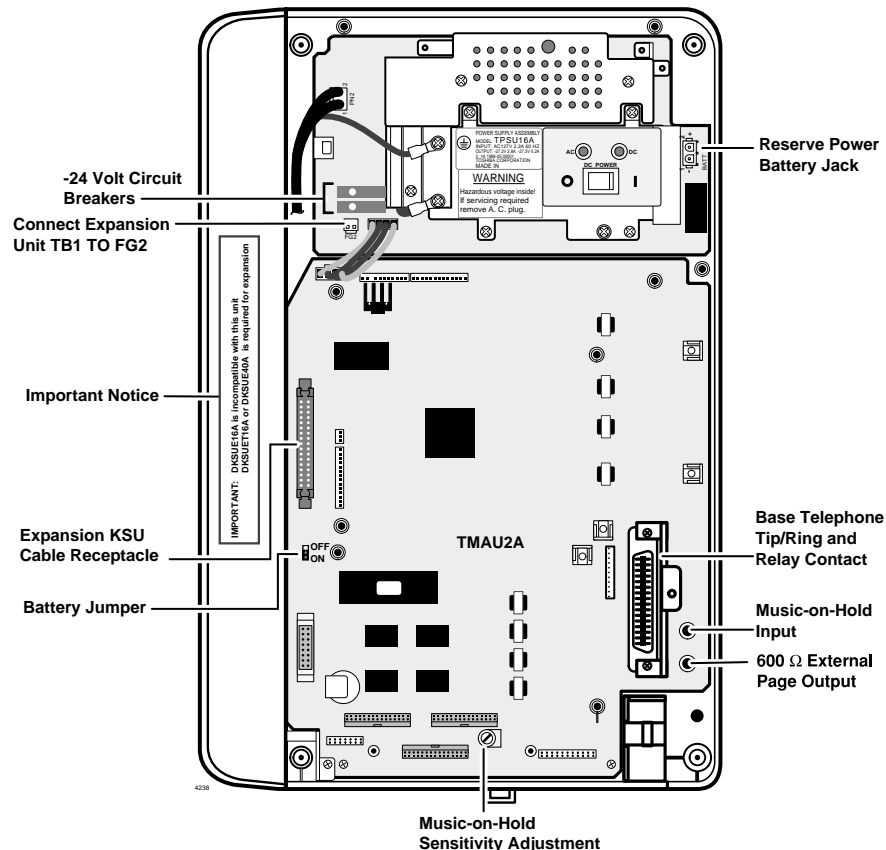

Figure 6 Base KSU Interior

Digital Telephone Circuits

The main circuit board (TMAU2) in the Strata DK40i Base KSU has eight integrated circuits that can connect to Toshiba-proprietary digital telephones (including the cordless telephone), Stand-alone Data Interface Units (PDIU-DSs), Digital Door Phone/Lock Control Units (DDCB), and Digital Direct Station Selection Consoles (DDSS).

Furthermore, each of the digital telephones can support a PC Data Interface Unit (RPCI-DI) or up to two Add-on Modules (DADMs).

Central Office (CO) Line Circuits (TCOU/TDDU/TBSU)

A TCOU PCB can be installed in the Base KSU to provide four circuits for loop start CO lines. Or, a TDDU PCB can be installed to provide four circuits for Direct Inward Dialing (DID) lines. Or, the TBSU can be installed to provide two circuits for BRI lines or stations (see TBSU below).

The CO line interface and DID interface unit can be programmed for DTMF or dial pulse signaling and each line has a switch to control potential excess volume that could be created by a nearby PBX or CO. Built-in gas tubes help protect each TDDU and TCOU line from lightning. An optional RDDU (for DID lines) installed in the Expansion Unit requires an external secondary protector. DID lines require the optional K5RCU2 tone receiver.

ISDN BRI S/T Circuits (TBSU)

The TBSU PCB provides two Basic Rate Interface (BRI) circuits for DK40i. The TBSU can only be installed in the DK40i Base KSU.

The TBSU contains two circuits, each of which reduces the system capacity by two station ports or two CO lines. If the BRI circuit is configured a station circuit, the circuit assumes two station ports. If the BRI circuit is configured as a line circuit, the circuit assumes two CO lines. BRI lines can be used for voice and data calls.

The TBSU circuits are four-wire S/T type circuits and connect to the PSTN BRI lines using a dealer-supplied UL-listed Network Terminator unit (NT1). In Canada, the NT-1 must be CSA certified. On the station side, they can connect to S-type ISDN Terminal Equipment (TE) or Terminal Adapters (TA).

Caller ID (TCIU2)

An optional Caller ID PCB (TCIU2) can be added to the four-circuit loop start CO line PCB (TCOU) to provide four Caller ID circuits. Local telephone companies do not provide Caller ID on DID lines; so the TCIU2 PCB cannot be added to the four-circuit DID PCB (TDDU). Caller ID can also be added with the RCIU2 and KCDU2. See [“Caller ID Interface Unit \(RCIU2\)” on Page 41](#) and [“Caller ID” on Page 65](#) for more information.

Standard Telephone Interface Unit (KSTU2)

The optional KSTU2 provides four circuits that can interface with DTMF for rotary dial standard telephones and other single-line devices, including: Strata AirLink Wireless Base Station Interface Adapters (BSIAs) and handsets, fax/modems (14.4 bps max.), Voice Mail and Auto Attendant devices, off-premises stations, alternate BGM source and dictation equipment. These devices may require that the optional tone receiver (K5RCU or K5RCU2) be installed in the DK40i Base KSU to interpret the DTMF signals the above devices may transmit.

The KSTU2 does not support message waiting lamps on standard telephones. The RSTU2 must be installed in the Expansion Unit to support message waiting lamps.

DTMF/ABR Tone Detection Receiver (K5RCU and K5RCU2)

Station users in systems that have the optional K5RCU or K5RCU2 installed can access Automatic Busy Redial (ABR) and communicate with devices, such as standard telephones or voice mail machines that require DTMF signaling.

This unit is also required for Direct Inward System Access (DISA) and built-in or external Auto Attendant operation, as well as for DID and Tie lines. Each K5RCU or K5RCU2 PCB contains five shared receivers.

Auto Attendant Feature Key (KKYS)

The system can be upgraded with an optional built-in Auto Attendant (AA). The KKYS installs onto the K5RCU PCB in the Base KSU.

SMDR, SMDI, and Maintenance DKAdmin/Modem (TTY) Interface (TSIU)

The TSIU PCB provides two RS-232 interface ports (modular jacks) that allow the DK40i system to connect to an SMDR Call Accounting device, a DKAdmin PC or external modem for system maintenance/administration, or an SMDI interface for Voice Mail. It does not have a built-in modem capability.

Only one TSIU can be installed per DK40i system. When the TSIU PCB is installed, the PIOU can still be installed for zone paging, control relays, and an SMDR RS-232 interface, built-in (IMDU) maintenance modem, or an SMDI or maintenance interface.

Power Supply

The power supply generates +5VDC and -24VDC for the entire system, even in its expanded configuration. (See [Table 5](#) for a summary of electrical/environmental characteristics.)

Table 5 Summary of Electrical/Environmental Characteristics

DK40i Primary Power	
Input AC	115VAC \pm 10VAC
AC frequency	50/60 Hz
Power	75 watts maximum
AC input current	1.8A maximum
Environmental Specifications	
Operating temperature	32~104° F (0 ~40° C)
Operating humidity	20~80% relative humidity without condensation
Storage temperature	-4~158° F (-20~70° C)
Power Supply	
DC voltage output specification	-24VDC (-25.94~-28.66VDC) +5VDC (+4.5~+5.5VDC) -5VDC (-4.5~-5.5VDC) - Expansion KSU only
Battery Charger Characteristics	
	Charger: current limiting Nominal float voltage: 2.275 volts/cell Charge current: 0.7 amps maximum Battery discharge cut-off voltage: 20.5 \pm 0.5VDC
KSTU2	
Ring voltage	Square wave output with high/low option jumper: Low position 130 \pm 20VDC peak-to-peak (no-load) High position, 190 \pm 25VDC peak-to-peak (no-load)
Ringing capability	2 ringers maximum per circuit, high or low position
RSTU2 or RDSU	
Ring voltage	80V RMS sine wave
Ringing capability	one ringer per circuit, with or without Message Waiting
RSTU2 (only) Message Waiting voltage	-90 VDC/one telephone per circuit (max.)
RSTU2 or RDSU modem interface data rate	14,400 bps maximum

The power supply provides a built-in charger for the batteries (see [Table 6](#)). Two customer-supplied 12-volt batteries can be connected to the power supply to maintain fully functioning operation during a power failure.

Table 6 Typical Reserve Power Duration Estimates

Description	DK40i Base KSU		DK40i Expansion KSU			
	No KSTU2	KSTU2	1 PCB	2 PCBs	3 PCBs	4 PCBs
Approximate (-24V) current drain (DC amps.)	1.0	1.2	1.6	2.0	2.4	2.8
Estimated battery operation time (in hours)	75.0	58.0	41.0	31.0	25.0	20.0

Reserve power time estimates assume the following:

- Batteries are fully charged at start of operation and two batteries are connected in a series (12 VDC, rated 80 amp/hours each).
- Batteries used for this test are gel-cell and maintenance free. Reserve duration will vary depending upon battery type, age, and manufacturer. These figures should be used as an estimate.
- AC power must be available when first installing reserve power batteries.

Power Failure Interface

The Base KSU provides an interface for a dedicated backup standard telephone during an AC input power failure. If the system AC input power fails, the backup telephone automatically connects to the CO1 line. The backup telephone is disabled when the system operates during normal power conditions.

This feature is independent of Battery Backup and is available when loop start lines are installed in the Base KSU. A power failure telephone cannot be installed for DID lines.

Music-on-Hold Interface

Customers can connect their own MOH source to this interface. The source can also feed external page speakers and telephone speakers with BGM.

- ♦ **Paging Interface** – This 600-ohm interface supports a Toshiba External Speaker (HESB) or a customer-supplied amplifier and speaker for Paging, Night Ringing over Page, and BGM.
- ♦ **Flexible Relay Contacts** – A relay contact can be programmed to either mute BGM during a page announcement over external speakers, to operate a device: i.e., an answering machine or ringing bell during the Night Mode, or to provide on-off control for a MOH source.

Expansion KSU Architecture

The optional Expansion KSU, which attaches easily to the side of the Base KSU, offers four universal slots that can host a variety of line and telephone PCBs (see [Figure 7](#)). See [Chapter 4 – Universal Slot PCBs](#) for descriptions of PCBs.

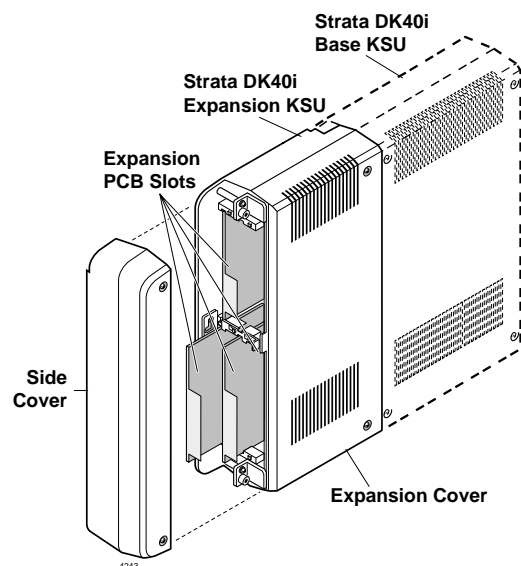

Figure 7 Expansion KSU Interior

Typical Line Configurations

This section shows the maximum basic and CO configurations that are possible with the DK40i. There is a variety of configuration combinations of digital and standard telephones with CO lines, including loop start, ground start, Tie, and DID lines. Any loop or ground start CO line can be equipped with Caller ID.

DK40i Line and Station Capacity

The following table shows maximum capacity for a DK40i system (see [Table 7](#)). See the *Strata DK Installation and Maintenance Manual*, Chapter 2 – DK40i Configuration for details.

Table 7 Maximum CO Lines/Ports and BRI Line and Station Circuits

Hardware	Maximum Allowed
CO Lines	12
Station Ports	28
BRI Line Circuits	6
BRI Station Circuits	10

Attaining maximum system capacities depends on power consumption of a particular configuration. Power factor calculations in accordance with the *Strata DK I&M Manual* will determine if the maximum capacities in these tables can be reached.

Stations can be a combination of ISDN TE-1 and TA S-type devices and digital, electronic or standard telephones. CO line combinations include ground or loop start, DID, Tie or ISDN BRI. Each BRI line circuit uses up two CO lines at system capacity. All other line circuits use up one CO line of system capacity.

Each BRI station circuit uses up to two station ports of system capacity. All other station circuits use up one station port of system capacity.

Table 8 Typical Maximum Capacity Examples with ISDN BRI (S/T and/or U-type) Circuits

BRI Station Circuits	BRI Station B channels	Other Station Circuits	BRI Line Circuits	BRI Line B channels	Other Line Circuits
10	20	8	6	12	0
8	16	12	4	8	4
6	12	16	4	8	4
4	8	20	6	12	0
4	8	20	4	8	4
2	4	24	2	4	8
0	0	28	0	0	12

Network Requirements

See [Table 37 on Page 110](#) for network requirements of station and line PCBs and interface cards.

Functional Block Diagram

See Figure 8 shows the Strata DK40i Base and Expansion KSU PCBs and the available lines, stations and peripherals. Basic voltage and cabling information is also included.

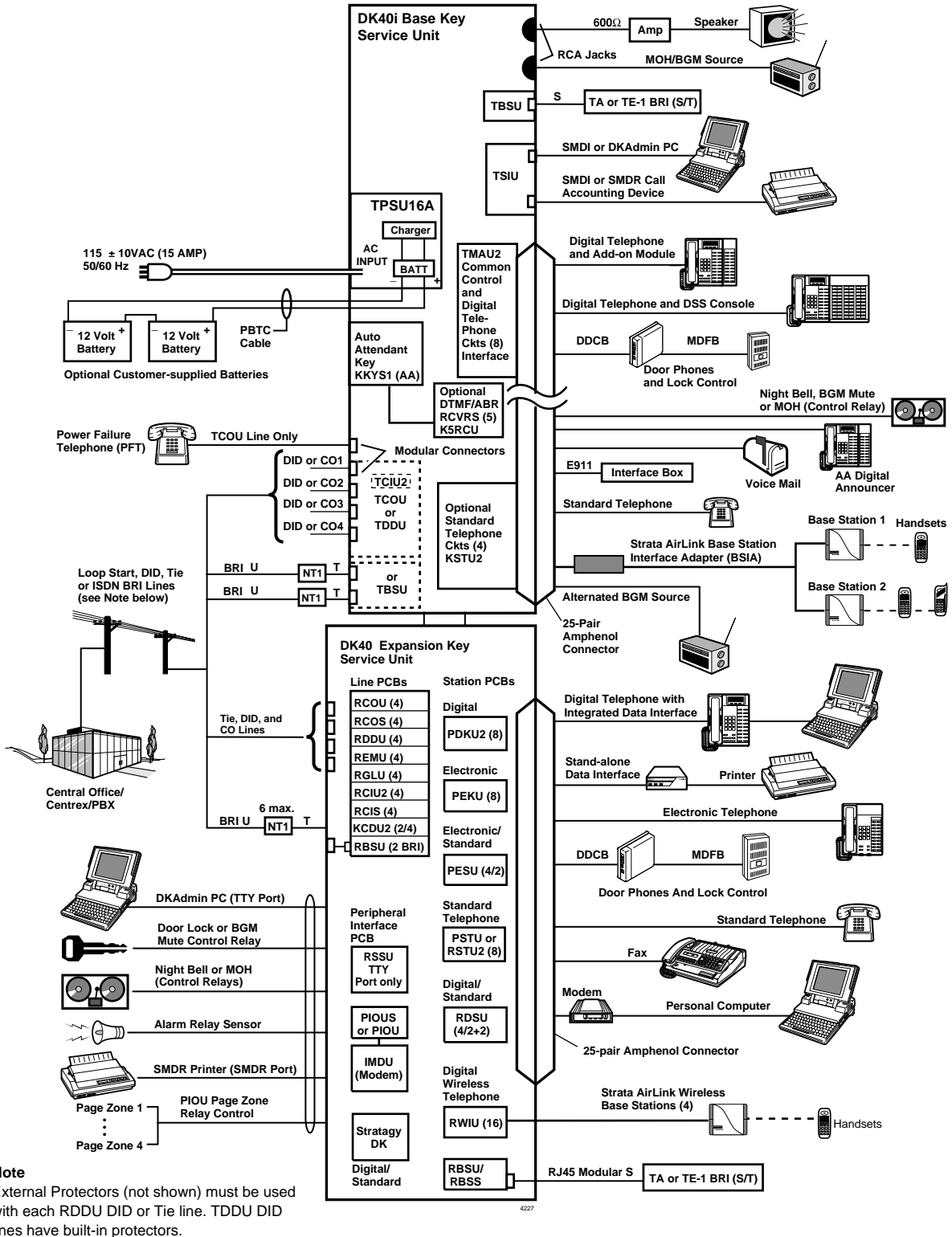

Figure 8 Functional Block Diagram

System Technology

Pulse Code Modulation

Digital switching talkpaths enable all CO and intercom lines to be accessed simultaneously. Analog-to-digital and digital-to-analog conversion is done by CODECs (coder plus decoder) on station and CO line PCBs.

Custom Electronic Circuitry

Large Scale Integration (LSI) technology enables the Strata DK40i circuit designs to be simple and efficient. Gate arrays using very large scale integration save vast amounts of space by using the latest technology. More circuitry fits onto smaller PCBs for a more compact system. Widespread use of CMOS circuits minimize system power requirements.

Stored Program Control

The system uses a 16-bit microprocessor for stored program control. Strata DK40i system operating software is stored on Read Only Memory (ROM), and individual configuration and custom programming is stored on Random Access Memory (RAM). A lithium battery with a life span of at least six years preserves RAM in the case of a power failure.

Microprocessors

The system's main microprocessor is a 16-bit 68000-type that operates at a clock speed of 8 MHz. In addition, some PCBs use 8-bit, TMP90C840-type local microprocessors that run at 10 MHz. This distributed microprocessing architecture is used system-wide.

Maintenance and Programming

Hardware maintenance and repair procedures describe how to quickly locate, remove, and replace defective parts and PCBs. System programming can be performed without taking the system out-of-service.

On-site programming can be executed with any 20-button proprietary Liquid Crystal Display (LCD) telephone or with a DKAdmin PC connected to an optional maintenance port.

Off-site programming with DKAdmin, which can help cut costs and save time, is available through a customer-provided modem connected to the maintenance port. DK40i (only) provides an optional built-in modem for remote administration and maintenance.

DKAdmin/DKBackup

Toshiba DKAdmin software Release 4.0 enables DK40i customer data (configuration, station, and system options) to be downloaded to a PC and stored on a computer disk. The customer data can be added to, or changed, using the PC independent of the DK System.

The new customer data can then be uploaded to the DK System from the PC, changing customer program options on-site or remotely over telephone lines and/or modems.

The DKBackup software program is also available. The program consists of a small subset of DKAdmin functions which can perform backup, restore and upgrade functions, but cannot edit customer databases.

Strata AirLink Wireless System

The Strata AirLink™ Wireless Telephone system that is configured to standard ports of the Strata DK and many non-Toshiba telephone systems has software that enables a System Administrator or technician to quickly diagnose error messages, alarms, and traffic conditions by viewing a PC monitor before troubleshooting the hardware.

The Status Window, displayed by the Strata AirLink Manager software, is an active window in which viewing reports, querying the software, and rebooting the Base Station Interface Adapter (BSIA) is possible. Some of the available reports are:

- ♦ Base Station channels status
- ♦ Line status
- ♦ Call status
- ♦ Critical alarms

The software also creates log files and sends error messages to the PC monitor to assist the technician in making corrections. The log files are easily opened in any text editor for viewing and have information about the BSIA boot software, Base Station upgrades, software queries, errors, and alarms.

RWIU Wireless System

The Strata AirLink Wireless Telephone system that is configured to Strata DK telephone systems using its own proprietary RWIU PCB also has software that enables a System Administrator or technician to:

- ♦ Set system IDs and enter handset IDs
- ♦ Set the time and date, and change passwords
- ♦ Enable UTAM
- ♦ Change communication ports
- ♦ Check the software version of the RWIU and Base Stations
- ♦ View log messages
- ♦ Reset and upgrade Base Stations and the RWIU
- ♦ Change Base Station numbers

LEDs and BER Testing

There are several LEDs on each Base Station, BSIA, and the RWIU that indicate normal, boot up, and alarm conditions. Signal fading and attenuation can be checked using the resident Bit Error Rate (BER) test in each handset for additional troubleshooting and maintenance routines.

This chapter presents the Strata DK424, a private telephone system tailor-made for small- to medium-sized business applications. It employs state-of-the-art technology to provide users with an efficient, easy-to-use, feature-rich telephone system.

A modular design and a choice of four common control units enables the system to fit a variety of customer needs and capacities.

The system line and station capacity can be increased by adding additional cabinets (see [Figure 9](#) and [Table 9](#)) which have universal slots capable of interfacing with almost any of the line, station, and option interface PCBs available with the system.

Strata DK424 easily connects to outside public telephone lines (CO lines). All of the telephones (stations) tied to the system can have direct access to each other as well as to the public network.

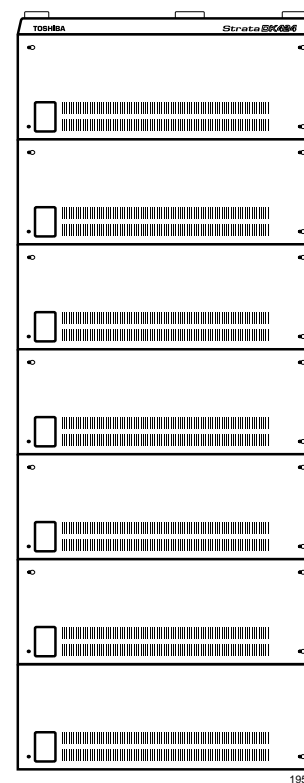

Figure 9 Base/Expansion Cabinets

Architecture

Base and Expansion Cabinets

The Base Cabinet and optional Expansion Cabinets are the building blocks of the system.

Each system has a Base Cabinet, and can have from one to six Expansion Cabinets. All lines, stations, and options are tied together through the cabinets.

Table 9 Cabinet Specifications

Cabinet	Weight	Height	Width	Depth
Base Cabinet (DKSUB424)	30.0 pounds (13.6 kg)	11.8 inches (300 mm)	23.6 inches (600 mm)	9.8 inches (249 mm)
Expansion Cabinet (DKSUE424)	28.4 pounds (12.9 kg)	10.0 inches (254 mm)	23.6 inches (600 mm)	9.8 inches (249 mm)

Expansion and Configuration

System station and CO line capacity is increased with the addition of cabinets and CO line and/or station PCBs. Tables 11~15 show the number of stations and lines allowed when additional cabinets and PCBs are used.

Base Cabinet

The Base Cabinet reserves two slots specifically for the system common control unit, labeled “R11” and “RCTU.” The Base Cabinet also has six universal slots, labeled “S11 ~ S16,” which can accommodate any station, line or option PCB (see Figure 10).

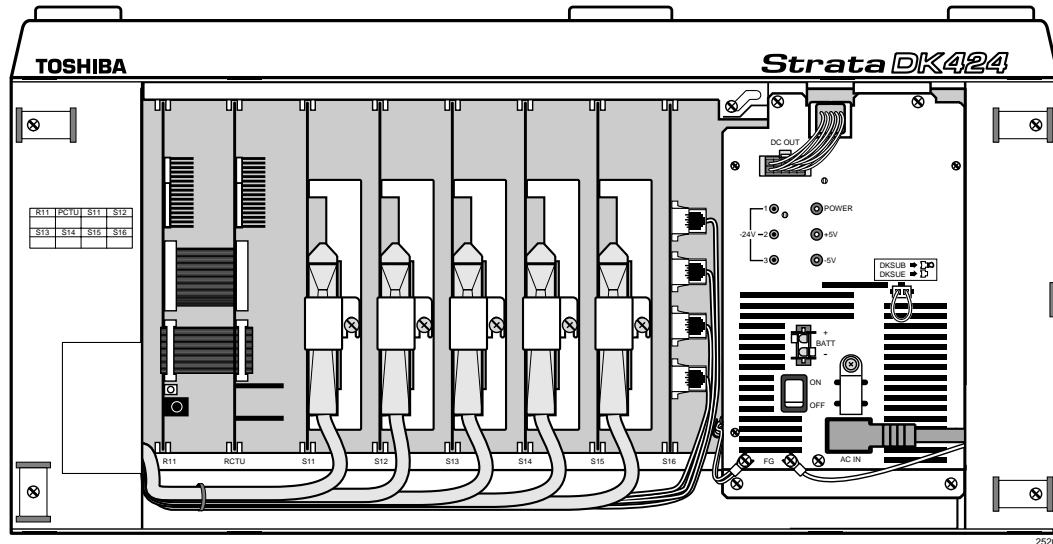

Figure 10 Base Cabinet Interior

Common Control Units

The system operates with one of four common control units (RCTUA, RCTUBA/BB, RCTUC/D, or RCTUE/F). These common control units (sometimes called the “RCTU processors”) can only be installed in the Base Cabinet.

- ◆ The RCTUA unit consists of a single PCB.
- ◆ The RCTUBA/BB, RCTUC/D and RCTUE/F common control units consist of two PCBs.

The RCTU also has a MOH/BGM source interface, and connectors to mount optional DTMF receiver PCBs needed for DISA, Tie/DID/Dialed Number Identification Service (DNIS)/ Automatic Number Identification (ANI) lines, voice mail, AA announcement devices, DTMF standard telephones, and other peripherals. The RCTU provides an interface for connecting an optional feature key (RKYS).

The common control unit contains the system's main 16 or 32-bit, 68000-type microprocessor and microprocessor bus, battery-protected memory circuits, time switch logic, ABR tone detectors, and system tones. (See Figure 12 on Page 29 for more information.)

Expansion Cabinets

The Expansion Cabinets have eight universal slots, “S_1” ~ “S_8.” Each of the universal slots can interface with station, line, or option PCBs. Slots “S_1” ~ “S_6” are available with the RCTUA, RCTUBA/BB, or RCTUC/D. Slots “S_7” and “S_8” are only available with the RCTUE/F processor. See Figure 11 for slot numbers. The number of expansion cabinets varies according to processor capacity (see Tables 16~19).

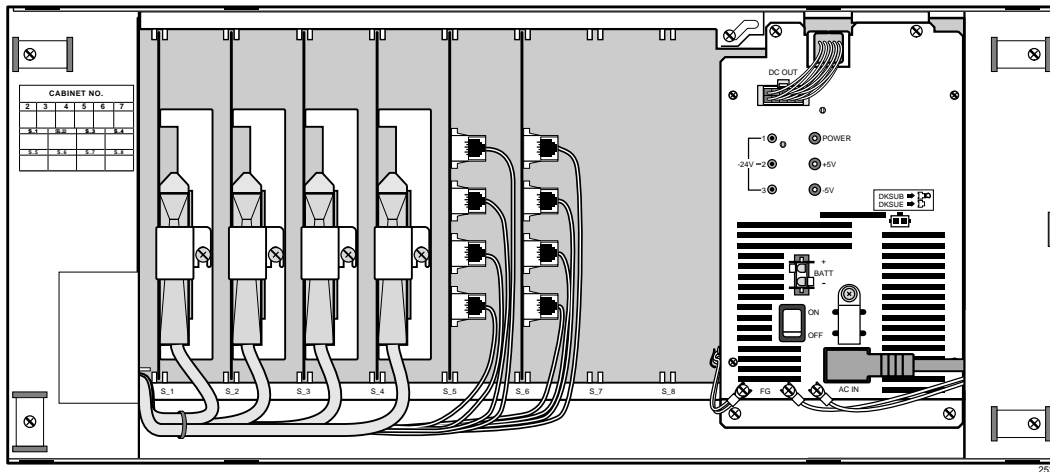

Figure 11 Expansion Cabinet Interior

Cabinet PCB Subassemblies

Subassemblies can be added within the Strata DK cabinets to provide additional features or to increase line capacity. Also see [“Summary of PCBs and Subassemblies”](#) on [Page 40](#).

DTMF Receiver Subassembly (RRCS)

The RRCS translates DTMF tones from DID/Tie/ANI/DNIS/DISA lines, built-in AA, DTMF standard telephones, and other peripheral devices to data signals for the system.

The RRCS can be attached to the common control unit and is available with either 4, 8, or 12 (RRCS-4, -8 or -12) shared receiver circuits. See [Table 32 on Page 88](#) for more information.

RKYS Feature Key Upgrades

The system can be upgraded for built-in AA, Automatic Call Distribution (ACD), Software Management Information System (SMIS) for ACD, and for Insight DK with the following feature keys that attach to the common control unit. See [Table 10](#) for a list of features provided by RKYS feature keys.

Table 10 RKYS Features

Feature(s) Provided	RKYS1	RKYS2	RKYS3	Common Control Unit
Built-in Auto Attendant	X	X	X	Applies to all RCTUs
ACD		X	X	RCTUBA/BB, RCTUC/D or RCTUE/F
ACD with MIS data information			X	RCTUBA/BB, RCTUC/D or RCTUE/F

Printed Circuit Boards (PCBs)

PCBs are installed in the cabinets to provide interface for stations, lines, and peripherals. Each PCB measures 7.5 x 5.5 inches (190 x 140 mm) and mounts in the slot with a 44-pin backplane connector. PCB external connections to station equipment are made to the Main Distribution Frame (MDF) using industry-standard connectors. For more details, see [Chapter 5 – Stations and Peripherals](#).

Maximum Line/Station Capacities

A summary of the maximum number of lines and stations by processor is shown in [Tables 11~19](#). Attaining maximum system capacities depends on power consumption of a particular configuration. Power factor calculations in accordance with the *Strata DK I&M Manual* will determine if the maximum capacities in these tables can be reached.

Configurations for a fully expanded system can range from 84 lines/336 stations to a squared system of 200 outside lines/224 stations.

See [Table 11](#) for the station and line capacities for eight-port RCOU/RCOS CO line PCBs, with one slot reserved for an optional interface PCB. There is a trade-off between stations and lines. Every group of eight stations installed decreases the CO line capacity of the system by eight, and vice versa.

The following table assumes one cabinet slot is used for an Optional Interface PCB.

Table 11 Configuration for Eight-Circuit CO Line PCBs (RCOU/RCOS) Without Caller ID

1 Cabinet RCTUA		2 Cabinets RCTUB or RCTUBA/BB		3 Cabinets RCTUC/D		4 Cabinets RCTUC/D		5 Cabinets RCTUC/D		6 Cabinets RCTUC/D		7 Cabinets RCTUE/F	
CO Lines	Stations	CO Lines	Stations	CO Lines	Stations	CO Lines	Stations	CO Lines	Stations	CO Lines	Stations	CO Lines	Stations
16	24	48	40	72	64	96	88	120	112	144	136	200	224
		44	40	68	64	92	88	116	112	140	136	196	224
		40	48	64	72	88	96	112	120	136	144	192	232
		36	48	60	72	84	96	108	120	132	144	188	232
		32	56	56	80	80	104	104	128	128	152	184	240
		28	56	52	80	76	104	100	128	124	152	180	240
		24	64	48	88	72	112	96	136	120	160	176	248
		20	64	44	88	68	112	92	136	116	160	172	248
		16	72	40	96	64	120	88	144	112	168	168	256
		12	72	36	96	60	120	84	144	108	168	164	256
		8	80	32	104	56	128	80	152	104	176	160	264
				28	104	52	128	76	152	100	176	156	264
				24	112	48	136	72	160	96	184	152	272
				20	112	44	136	68	160	92	184	148	272
						40	144	64	168	88	192	144	280
						36	144	60	168	84	192	140	280
						32	152	56	176	80	200	136	288
						28	152	52	176	76	200	132	288
						24	160	48	184	72	208	128	296
								44	184	68	208	124	296
								40	192	64	216	120	304
								36	192	60	216	116	304
								32	200	56	224	112	312
										52	224	108	312
										48	232	104	320
										44	232	100	320
										40	240	96	328
												92	328
												88	336
												84	336

Tables 12~15 assume one cabinet slot is used for an Optional Interface PCB.

Table 12 Configuration for Four Circuit DID or Tie Line PCBs

1 Cabinet RCTUA		2 Cabinets RCTUB or RCTUBA/BB		3 Cabinets RCTUC/D		4 Cabinets RCTUC/D		5 Cabinets RCTUC/D		6 Cabinets RCTUC/D		7 Cabinets RCTUE/F	
CO Lines	Stations	CO Lines	Stations	CO Lines	Stations	CO Lines	Stations	CO Lines	Stations	CO Lines	Stations	CO Lines	Stations
8	24	24	40	36	64	48	88	60	112	72	136	100	224
4	32	20	48	32	72	44	96	56	120	68	144	96	232
		16	56	28	80	40	104	52	128	64	152	92	240
		12	65	24	88	36	112	48	136	60	160	88	248
		8	72	20	96	30	120	44	144	56	168	84	256
		4	80	16	104	28	128	40	152	52	176	80	264
				12	112	24	136	36	160	48	184	76	272
				10	120	20	144	32	168	44	192	72	280
						16	152	28	176	48	200	68	288
						12	160	24	184	36	208	64	296
								20	192	32	216	60	304
								16	200	28	224	56	312
										24	232	52	320
										20	240	48	328
												44	336

Table 13 Eight Circuit (RCOU/RCOS) CO Loop Start Analog Lines with Caller ID Maximum Capacities

1 Cabinet RCTUA		2 Cabinets RCTUBA/BB		3 Cabinets RCTUC/D		4 Cabinets RCTUC/D		5 Cabinets RCTUC/D		6 Cabinets RCTUC/D		7 Cabinets RCTUE/F	
Lines	Stations	Lines	Stations	Lines	Stations	Lines	Stations	Lines	Stations	Lines	Stations	Lines	Stations
8	24	24	40	40	56	56	72	72	88	88	104	136	152
		16	56	32	72	48	88	64	104	80	120	128	168
		8	72	24	88	40	104	56	120	72	136	120	184
				16	104	32	120	48	136	64	152	112	200
						24	136	40	152	56	168	104	216
								32	168	48	184	96	232
										40	200	88	248
												80	264

Table 14 Four Circuit (RGLU) CO Ground Start Analog Lines with Caller ID Maximum Combined Capacities

1 Cabinet RCTUA		2 Cabinets RCTUBA/BB		3 Cabinets RCTUC/D		4 Cabinets RCTUC/D		5 Cabinets RCTUC/D		6 Cabinets RCTUC/D		7 Cabinets RCTUE/F	
Lines	Stations	Lines	Stations	Lines	Stations	Lines	Stations	Lines	Stations	Lines	Stations	Lines	Stations
8	16	20	24	32	40	44	48	56	64	68	72	104	112
		16	40	28	48	40	64	52	72	64	88	100	120
		8	64	24	64	36	72	48	88	60	96	96	136
				16	88	32	88	44	96	56	112	92	144
				12	96	28	96	40	112	52	120	88	160
						24	112	36	120	48	136	84	168
						20	120	32	136	44	144	80	184
						16	136	28	144	40	160	76	192
								24	160	36	168	72	208
										32	184	68	216
										28	192	64	232
												60	240
												56	256

Table 15 Digital, Tie, DID, Ground/Loop Start Digital T1 and ISDN PRI Lines Maximum Combined Capacities

2 Cabinets RCTUBA/BB		3 Cabinets RCTUC/D		4 Cabinets RCTUC/D		5 Cabinets RCTUC/D		6 Cabinets RCTUC/D		7 Cabinets RCTUE/F	
Lines	Stations	Lines	Stations	Lines	Stations	Lines	Stations	Lines	Stations	Lines	Stations
48	56	72	88	112	112	120	152	144	144	192 ¹	240
40	64	64	96	96	120	112	160	120	168	184	248
24	72	48	104	88	128	96	168	112	176	168	264
16	80	40	112	72	136	88	176	96	192	160	272
		24	120	64	144	72	184	88	200	144	288
		16	128	48	152	64	192	72	216	136	296
				40	160	48	200	64	224	120	312
				24	168	40	208	48	240	112	320
				16	176	24	216	—	—	96	336

Notes

- T1 lines can be in increments of 8, 16 and/or 24.
- PRI channels can be in increments of 23B+1D or 47B + 1D. Each B channel represents a PRI CO line

1. The maximum number of PRI lines for 2 cabinets is 47, 3~6 cabinets is 141 and 7 cabinets is 188.

Tables 16~19 show system maximum capacity examples with ISDN BRI (S/T and/or U) circuits.

Table 16 RCTUA Maximum Capacity Examples with ISDN BRI (S/T and/or U-type) Circuits

BRI Station Circuits ¹	BRI Station B channels ¹	Other Station Circuits ³	BRI Line Circuits ⁴	BRI Line B channels ⁴	Other Line Circuits ⁵
8 ²	16 ²	16	0	0	0
6	12	16	2	4	0
5	10	16	3	6	0
4	8	16	4 ²	8 ²	0
4	8	16	2	4	4
3	6	16	1	2	8
2	4	24	2	4	8
1	2	28	1	2	12

Table 17 RCTUBA/BB Maximum Capacity Examples with ISDN BRI (S/T and/or U-type) Circuits

BRI Station Circuits ¹	BRI Station B channels ¹	Other Station Circuits ³	BRI Line Circuits ⁴	BRI Line B channels ⁴	Other Line Circuits ⁵
16 ²	32 ²	32	8 ²	16 ²	0
12	24	40	8	16	8
10	20	40	8	16	12
8	16	48	8	16	16
8	16	48	6	12	20
8	16	56	4	8	24
8	16	56	2	4	28
6	12	56	6	12	24
6	12	56	4	8	28
6	12	64	2	4	32
4	8	64	4	8	32
4	8	64	2	4	32
2	4	72	2	4	40

- Each BRI circuit (S/T and/or U-type) provides two B channels plus one D channel and reduces the system capacity by two station ports and two CO lines. Each (S/T) BRI station circuit allows up to two TE-1 and TA devices to share the BRI B channels (two simultaneous calls maximum per BRI circuit.). Each BRI-U circuit supports one TE-1 or TA device.
- Maximum BRI capacity.
- Other stations include Toshiba digital and electronic telephones, or attendant consoles, standard telephones and devices.
- BRI S/T circuits are available with RBSU/RBSS PCBs and BRI-U circuits are available with RBUU/RBUS PCBs. ISDN BRI PCBs will be available with a future release of DK424 software. Each BRI line circuit (S/T or U) provides two BRI CO lines (B channels) for incoming/outgoing calls.
- Other lines include analog and digital (T1 or PRI) loop start, ground start, DID, and Tie lines.

Table 18 RCTUC/D Maximum Capacity Examples with ISDN BRI (S/T and/or U-type) Circuits

BRI Station Circuits ¹	BRI Station B channels ¹	Other Station Circuits ³	BRI Line Circuits ⁴	BRI Line B channels ⁴	Other Line Circuits ⁵
40 ²	80 ²	144	8 ²	16 ²	48
30	60	164	8	16	68
20	40	184	8	16	88
16	32	192	8	16	96
12	24	200	8	16	104
8	16	208	8	16	112
8	16	216	4	8	120
8	16	216	2	4	124
4	8	228	2	4	132

Table 19 RCTUE/F Maximum Capacity Examples with ISDN BRI (S/T and/or U-type) Circuits

BRI Station Circuits ¹	BRI Station B channels ¹	Other Station Circuits ³	BRI Line Circuits ⁴	BRI Line B channels ⁴	Other Line Circuits ⁵
64 ²	128 ²	192	8 ²	16 ²	56
50	100	216	8	16	84
40	80	240	8	16	104
30	60	256	8	16	124
20	40	280	8	16	144
16	32	288	8	16	152
8	16	304	8	16	168
8	16	312	4	8	176
8	16	312	2	4	180
4	8	320	4	8	184
4	8	320	2	4	188
2	4	328	2	4	192

1. Each BRI circuit (S/T and/or U-type) provides two B channels plus one D channel and reduces the system capacity by two station ports and two CO lines. Each (S/T) BRI station circuit allows up to two TE-1 and TA devices to share the BRI B channels (two simultaneous calls maximum per BRI circuit.). Each BRI-U circuit supports one TE-1 or TA device.
2. Maximum BRI capacity
3. Conventional stations include Toshiba digital and electronic telephones, or attendant consoles, standard telephones and devices.
4. BRI S/T circuits are available with RBSU/RBSS PCBs and BRI-U circuits are available with RBUU/RBUS PCBs. ISDN BRI PCBs will be available with a future release of DK424 software. Each BRI line circuit (S/T or U) provides two BRI CO lines (channels) for incoming/outgoing calls
5. Conventional lines include analog and digital (T1 or PRI) loop start, ground start, DID, and Tie lines.

Power Requirements

Each Base and Expansion Cabinet houses a power supply that generates $\pm 5\text{VDC}$ and -24VDC which furnishes power to all of the stations and some of the peripherals that interface with the cabinet. A fully loaded Strata DK424 requires an input power source of $115\text{VAC} \pm 10\text{VAC}$ ($105\text{VAC} \sim 125\text{VAC}$), 17.5 amps., 50/60 Hz. (see [Table 20](#)).

Table 20 DK424 Summary of Electrical/Environmental Characteristics

DK424 Primary Power	
Input AC	115VAC \pm 10VAC
AC amps for seven-cabinet system	20 amp circuit
AC frequency	50/60 Hz
Watts per cabinet (continuous)	180
Watts for six cabinet system (continuous)	845
DK424 Maximum Peak AC Input Current	
1 cabinet – 2.5 amps	5 cabinets – 11.5 amps
2 cabinets – 5.0 amps	6 cabinets – 15.0 amps
3 cabinets – 7.5 amps	7 cabinets – 17.5 amps
4 cabinets – 10.0 amps	
Environmental Specifications	
Operating temperature	32~104° F (0~40° C)
Operating humidity	20~80% relative humidity without condensation
Storage temperature	-4~158° F (-20~70° C)
Power Supply	
DC voltage output specification	-24VDC (-26.3~-27.8VDC) +5VDC (+4.5~+5.5VDC) -5VDC (-4.5~-5.5VDC) - Expansion Cabinet only
Battery Charger Characteristics	
	Charger: current limiting Nominal float voltage: 2.275 volts/cell Charge current: 0.7 amps maximum Battery discharge cut-off voltage: 20.5 \pm 0.5VDC
PESU (Circuits 1 and 2)	
Ring voltage	Square wave output with high/low option jumper: Low position 130 \pm 20VDC peak-to-peak (no-load) High position, 190 \pm 25VDC peak-to-peak (no-load)
Ringing capability	2 ringers maximum per circuit, high or low position
RSTU2 or RDSU	
Ring voltage	80V RMS sine wave
Ringing capability	1.5 REN per circuit, with or without Message Waiting
RSTU2 Message Waiting voltage	-90 VDC/one telephone per circuit (max.)
RSTU2 or PESU modem interface data rate	14,400 bps maximum
BTU Rating	
PDKU (5) RCOU/RCOS (1) RCTUB (1) DKTs (40)	190 BTUs (56 watt hours) per cabinet
Traffic Rating Characteristics	
9 CCS per station system-wide 36 CCS per ACD/SMIS station	
Note There are system limits for the number of simultaneous Agents depending on traffic. See the <i>Strata DK Call Center Solutions General Description</i> for details.	

Two or four customer-supplied 12-volt reserve batteries can be connected to the system to maintain normal operation during a power failure (see [Table 21](#)). The batteries are kept in a highly-charged state by the standard power supply and must be connected when the system is operating normally. Fully charged batteries must be connected, and when normal AC power is available, batteries cannot be connected after/during an actual power failure.

Table 21 Typical Reserve Power Duration Estimates (in hours)

Number of Cabinets	1	2	3	4	5	6	7
2 batteries	16.0	8.0	5.0	3.7	3.09	2.5	2.1
4 batteries	32.0	16.0	10.0	7.5	6.0	5.0	4.2
Discharge Current	3.5A	6.7A	9.9A	13.1A	16.3A	19.5A	22.7A

Underwriters' Laboratory (UL) and local electrical codes require certain standards for connecting commercial AC and reserve power to the Strata DK424 system. [Table 22](#) describes which assemblies may be required to meet UL and local electrical code standards.

Floor Mount Hardware

The lightweight and compact design enables easy wall or floor mounting. The RFIF hardware kit is needed for floor mounting (see [Table 22](#)). If floor mounting three or more cabinets, AC and reserve power must be connected to the RCCB conduit connection box option by a licensed electrician. Wall mounting the system does not require special hardware.

Table 22 Cabinet Power, Reserve Power, and Floor Mount Hardware Assemblies

Assembly	Function
RBTC1A-2M	Reserve Power Cable – Two cables are required for up to six cabinet systems and three are required for seven cabinet reserve power installations (for current carrying capacity) when connecting reserve (battery) power to three or more cabinets (wall mount). RBDB2 is also required for connecting battery terminals—see “RBDB2” below. A licensed electrician must install this item to retain UL listing and/or local electrical code compliance.
PBTC-3M	Reserve Power Cable – Connects cabinet Power Supply to battery terminals. If reserve power is connected to one or two cabinets (wall or table mount), one cable is required for each cabinet. A licensed electrician must install this item to retain UL listing and/or local electrical code compliance.
RBDB2	Battery Distribution Box – Distributes reserve power when three or more cabinets require reserve power (floor or wall mount). Six RBTC2A-1.5M cables are provided with the RBDB2 distribution box to connect up to six DK424 power supplies to the battery distribution box. An RC7C1A-1.7M is also required for a seventh cabinet.
RC7C1A-1.7M	Cabinet 7 Cable Kit – Provides long data cable to connect the sixth Expansion Cabinet to the DK424 Base Cabinet. Provides a long battery cable to connect RBDB2 battery distribution box to the sixth Expansion Cabinet power supply. Data and battery cables used for seven cabinet installations only.
RFIF	Floor Mount Fixture Kit – Provides two metal stands for mounting three or more cabinets on floor; supports up to seven cabinets. Three pairs of wall brackets (RWBF) are supplied with RFIF. Wall brackets are needed to secure floor-mounted systems to the wall for safety purposes (not required for wall-mounted cabinets).

Table 22 Cabinet Power, Reserve Power, and Floor Mount Hardware Assemblies (continued)

Assembly	Function
RCCB1, RCCB2	Conduit Connection Box – This box is required for AC and battery power connection to three or more floor-mounted cabinets. (Not required for mounting two cabinets on a table or any number of cabinets on a wall.) A licensed electrician must install this item to retain UL listing and/or local electrical code compliance. RCCB1 supports up to six floor-mounted cabinets. RCCB2 supports up to seven floor-mounted cabinets.
RPSB1	Three-outlet AC Power Strip – One RPSB1 required when installing three or four cabinets (wall or floor mount). Two RPSB1s are required when installing five, six, or seven cabinets (wall or floor mount). Two AC cords will exit the cabinets in some configurations.
RPSB2	Three-outlet AC Power Strip – Used with a high current carrying capacity cord for application where local electric codes (or user) requires only one AC cord to exit four or more cabinets. Toshiba highly recommends using the RPSB2 for two-cabinet installations to accommodate further growth. Must be ordered for seven cabinet systems.
RWBF	Wall bracket pair – Required for floor mounted seven cabinet systems. Secures the seventh cabinet to the wall for safety (not required for wall-mounted cabinets – see RFIF).

Functional Block Diagrams

The Functional Block Diagrams shows the PCBs and interface connectors used for connecting the stations and peripherals (see Figures 12~14).

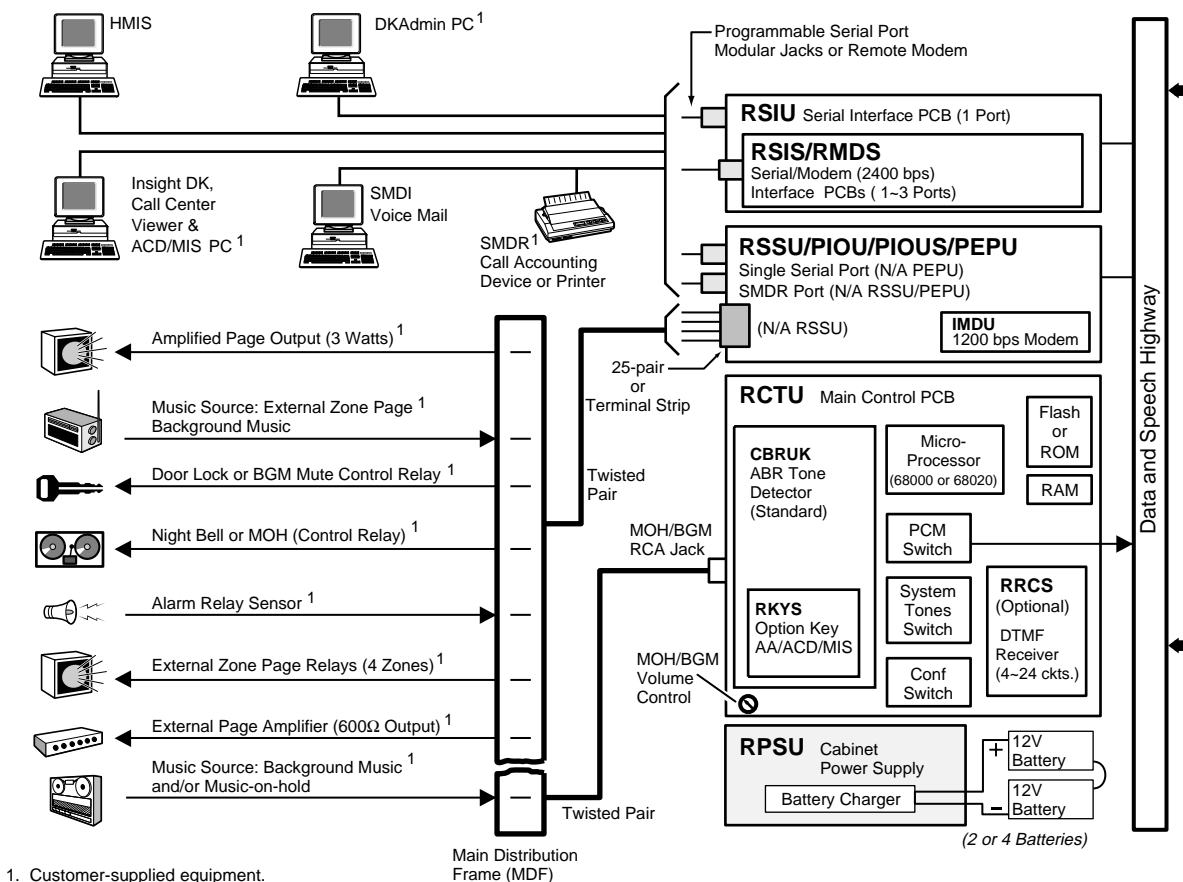
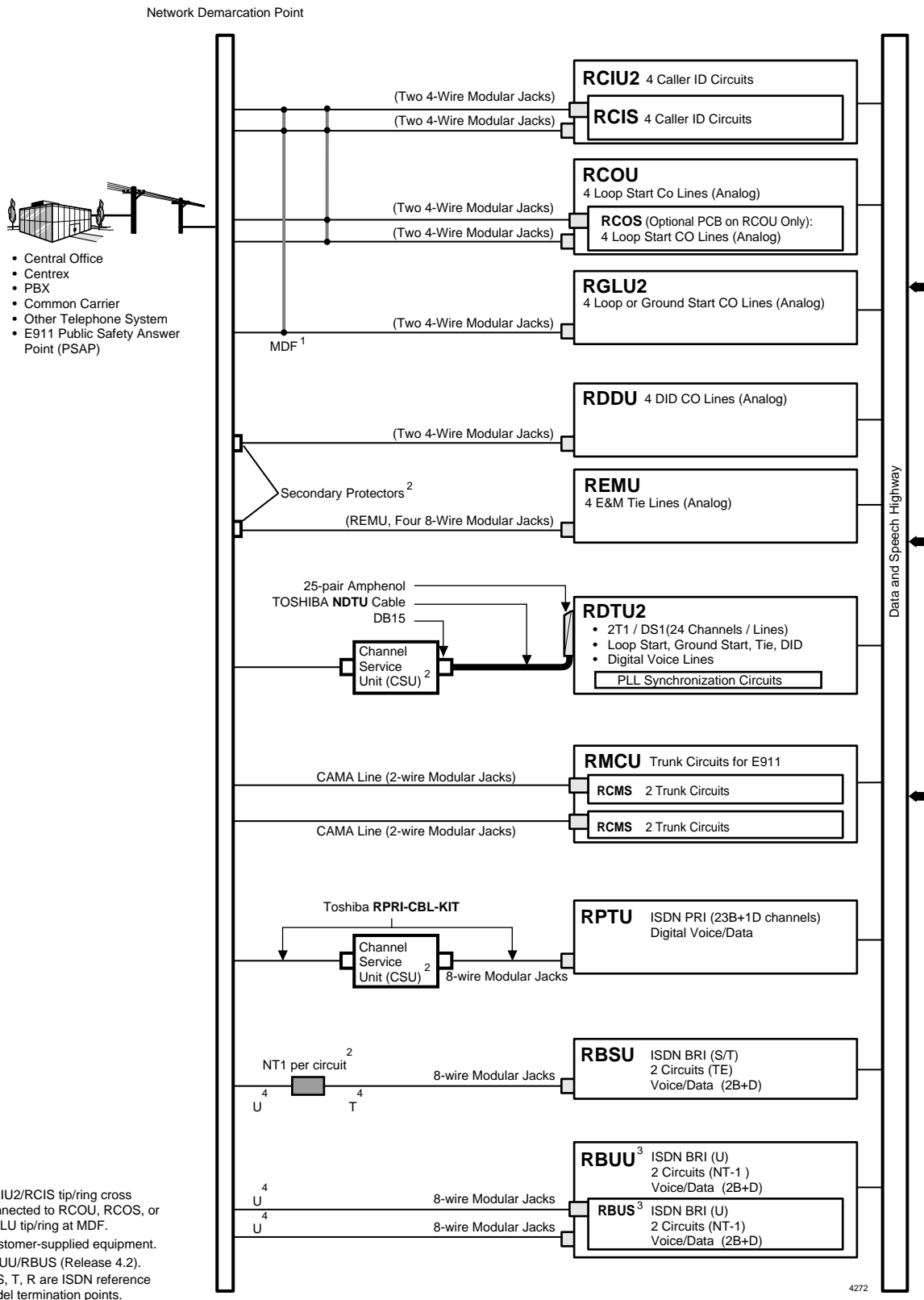
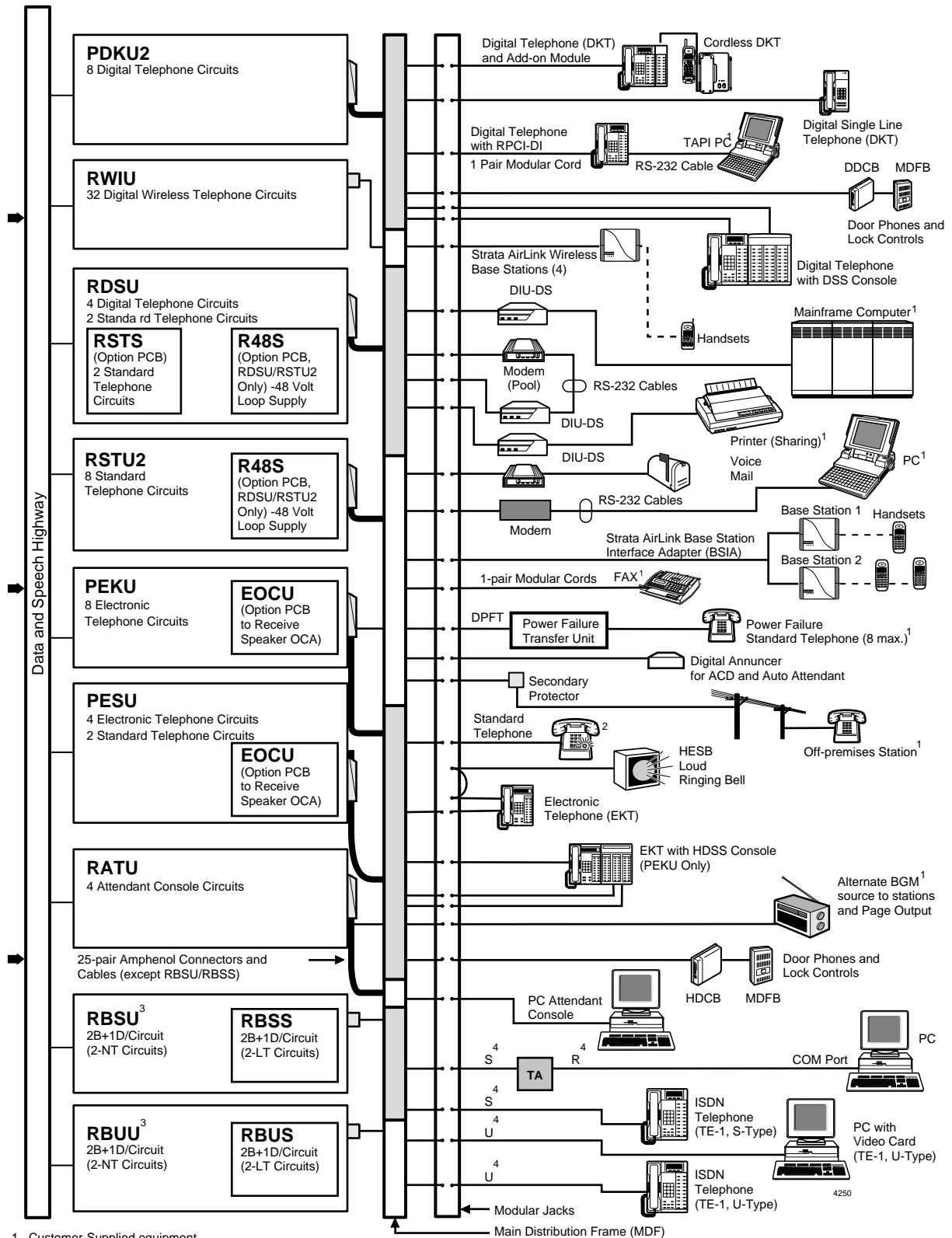

Figure 12 KSU Processor and Optional Interface PCBs



1. RCIU2/RCIS tip/ring cross connected to RCOU, RCOS, or RGLU tip/ring at MDF.
2. Customer-supplied equipment.
3. RBUU/RBUS (Release 4.2).
4. U, S, T, R are ISDN reference model termination points.

Figure 13 CO Line Side Functional Block Diagram



1. Customer-Supplied equipment
2. RSTU2 is required for standard telephone message waiting lamp.
3. RBUU/RBUS (Release 4.2).
4. U, S, T, R are ISDN reference model termination points.

Figure 14 Station Side Functional Block Diagram

System Technology

Pulse Code Modulation

Digital switching talkpaths enable all CO and intercom lines to be accessed simultaneously. Analog-to-digital and digital-to-analog conversion is done by CODECs (coder plus decoder) on station and CO line PCBs.

Custom Electronic Circuitry

Large Scale Integration (LSI) technology enables the Strata DK circuit designs to be simple and efficient. Gate arrays using very large scale integration save vast amounts of space by using the latest technology. More circuitry fits onto smaller PCBs for a more compact system. Widespread use of CMOS circuits minimize system power requirements.

Stored Program Control

The system uses a 16-bit microprocessor for stored program control. System operating software is stored on Read Only Memory (ROM), and individual configuration and custom programming is stored on Random Access Memory (RAM) for Strata DK. A lithium battery with a life span of at least six years preserves RAM in the case of a power failure.

Microprocessors

The system's main microprocessor is a 16-bit 68000-type that operates at a clock speed of 8 MHz. In addition, some PCBs use 8-bit, TMP90C840-type local microprocessors that run at 10 MHz. This distributed microprocessing architecture is used system-wide.

Maintenance and Programming

Hardware maintenance and repair procedures describe how to quickly locate, remove, and replace defective parts and PCBs. System programming can be performed without taking the system out-of-service.

On-site programming can be executed with any 20-button proprietary LCD telephone or with a DKAdmin PC connected to an optional maintenance port.

DKAdmin/DKBackup

Toshiba DKAdmin/DKBackup software enables customer data (configuration, station, and system options) to be downloaded to a PC and stored on a computer disk. The customer data can be added to, or changed, using the PC independent of the DK System.

The new customer data can then be uploaded to the DK System from the PC, changing customer program options on-site or remotely over telephone lines and/or modems.

The DKBackup software program is also available. The program consists of a small subset of DKAdmin/DKBackup functions which can perform backup, restore and upgrade functions, but cannot edit customer databases.

Strata AirLink Wireless System

The Strata AirLink Wireless Telephone system that is configured to standard ports of the Strata DK and many non-Toshiba telephone systems has software that enables a System Administrator or technician to quickly diagnose error messages, alarms, and traffic conditions by viewing a PC monitor before troubleshooting the hardware.

The Status Window, displayed by the Strata AirLink Manager software, is an active window in which viewing reports, querying the software, and rebooting the Base Station Interface Adapter (BSIA) is possible. Some of the available reports are:

- ♦ Base Station channels status
- ♦ Line status
- ♦ Call status
- ♦ Critical alarms

The software also creates log files and sends error messages to the PC monitor to assist the technician in making corrections. The log files are easily opened in any text editor for viewing and have information about the BSIA boot software, Base Station upgrades, software queries, errors, and alarms.

RWIU Wireless System

The Strata AirLink Wireless Telephone system that is configured to Strata DK telephone systems using its own proprietary RWIU PCB also has software that enables a System Administrator or technician to:

- ♦ Set system IDs and enter handset IDs
- ♦ Set the time and date, and change passwords
- ♦ Enable UTAM
- ♦ Change communication ports
- ♦ Check the software version of the RWIU and Base Stations
- ♦ View log messages
- ♦ Reset and upgrade Base Stations and the RWIU
- ♦ Change Base Station numbers

LEDs and BER Testing

There are several LEDs on each Base Station, BSIA, and the RWIU that indicate normal, boot up, and alarm conditions. Signal fading and attenuation can be checked using the resident Bit Error Rate (BER) test in each handset for additional troubleshooting and maintenance routines.

This chapter describes each of the PCBs that install into the universal slots of the Strata DK40i Expansion KSU and the DK424 Base/Expansion Cabinets. The following paragraphs categorize the cards according to their function.

Descriptions here apply to both DK40i and DK424 unless noted otherwise. The DK14 does not support any universal slot PCBs.

Station PCBs

Feature subassemblies, such as the Standard Telephone Interface Subassembly (RSTS), are listed below the associated PCB. For a list of available subassemblies, see [Table 23 on Page 40](#).

Digital Telephone Interface Unit (PDKU2)

The PDKU2 has eight digital telephone circuits that can support digital telephones (cordless as well as corded), integrated PC interface data units for data calling and/or TAPI application, off-hook call announce, DDSS consoles or DADMs for attendant stations that must handle a heavy load of calls, and a DDCB for a variety of applications.

Each of these devices only requires one circuit except for the integrated PC interface unit or DADM, which shares a circuit with the telephone to which they are connected.

Digital/Standard Telephone Interface Unit (RDSU)

The RDSU in its basic configuration has two standard telephone circuits and four digital telephone circuits (cordless as well as corded). The standard telephone circuits can support the same devices that the RSTU2 can, with the exception of standard telephone message waiting lamps.

The digital circuits can support the same devices as the PDKU, except for the DDSS console. The RDSU can be equipped with an RSTS subassembly to provide two more standard telephone circuits, and an R48S subassembly to increase the standard telephone maximum loop length.

- ♦ **DK40i** – a K5RCU or K5RCU2 must be installed in the Base KSU to interpret DTMF tones transmitted by devices connected to the standard telephone circuits.
- ♦ **DK424** – an RRCS must be installed on the common control unit to interpret the DTMF signals for devices connected to the standard telephone circuits.

Standard Telephone Interface Subassembly (RSTS)

The RSTS attaches to the RDSU and adds two standard telephone circuits to the PCB. With the RSTS installed, the RDSU provides four standard telephone circuits and four digital telephone circuits. (RSTS does not support standard telephone message waiting.)

Strata AirLink Wireless Interface Unit (RWIU)

The RWIU interfaces the DK40i and DK424 with the Strata AirLink Telephone wireless system. The card functions as a protocol converter between the Base Stations and the PBX. It has four digital circuits that connect to four Base Stations using industry standard RJ11 jacks. Roaming and handoff functionality are present between all four Base Stations.

CO Line/Digital Telephone Interface Unit (KCDU) (DK40i only)

The KCDU provides two analog loop start CO line circuits and four digital telephone circuits. The CO line circuits offer all of the features that the Base TCOU and the RCOU line circuits provide. The digital telephone circuits can support every peripheral (except for the DDSS console) that the PDKU2 and a Base KSU digital circuit can support. Up to four KDCU PCBs can be installed in the DK40i Expansion Unit.

Note The RCIU2 Caller ID Interface Unit is required to add Caller ID with the KCDU PCB.

Electronic Telephone Interface Unit (PEKU)

The PEKU provides eight electronic telephone circuits that can interface with electronic telephones, an alternate BGM source, a Direct Station Selection Console (HDSS), an external amplifier for DISA or two-CO line Conferencing.

Standard/Electronic Telephone Interface Unit (PESU)

The PESU offers two standard and four electronic telephone circuits. Its standard circuits support the same devices as the KSTU2. Its electronic circuits interface with the same peripherals as the PEKU, except for the HDSS console.

- ♦ **DK40i** – a K5RCU or K5RCU2 must be installed in the Base KSU to interpret DTMF tones transmitted by devices connected to the standard telephone circuits.
- ♦ **DK424** – an RRCS must be installed on the common control unit to interpret the DTMF signals for devices connected to the standard telephone circuits.

Off-hook Call Announce Upgrade Unit (EOCU)

Electronic telephones connected to PEKU and PESU PCBs can receive speaker Off-hook Call Announce (OCA)—internal [DN] calls over their speaker while they are on another call—if the PCBs are equipped with an EOCU. Digital telephones also support this function, but do not require an EOCU in the KSU. Unlike digital telephones, electronic telephones cannot receive handset OCA.

Standard Telephone Interface Unit (RSTU2)

The RSTU2 has eight circuits that can support single-line devices (one device per RSTU2 port). Besides rotary and DTMF standard telephones, the RSTU2 can support the Strata AirLink Wireless analog system, fax machines, dictation equipment, modems, a separate BGM source, off-premises stations, Toshiba Strategy and VP voice mail systems, and digital announcement devices for optional built-in AA or ACD.

This PCB also supports the Message Waiting feature on standard telephones that are equipped with a 90VDC neon message waiting lamp.

The RSTU2 also provides an 80V RMS sine wave ring generator and has interface connectors for an optional R48S subassembly that increases the maximum possible station loop length from 600 to 1200 ohms.

- ✦ **DK40i** – a K5RCU or K5RCU2 must be installed in the Base KSU to interpret DTMF tones transmitted by devices connected to the standard telephone circuits.
- ✦ **DK424** – an RRCS must be installed on the common control unit to interpret the DTMF signals for devices connected to the standard telephone circuits.

48V Loop Voltage (R48S)

The optional R48S unit can be connected to the RSTU2 or RDSU, and, by creating 48V loop voltage instead of 24V, can extend the maximum possible loop length of standard telephone circuits (including the resistance of the phone) from 600 ohms to 1200 ohms, allowing standard telephones to be connected farther from the system.

By using this unit, a less expensive type of off-premises lines can be used (see [Table 23 on Page 40](#)).

Console PCBs

Attendant Console Interface Unit (RATU, DK424 only)

The RATU can support four attendant consoles. Multiple consoles enable automatic load-sharing on a rotation basis from a central call queue, increasing call handling efficiency. The RATU PCB in the Strata DK424 system cabinet connects to the PC Attendant Console Interface (RATI) via two pair of wires.

RATU is only available for systems operating with RCTUBA/BB, RCTUC/D or RCTUE/F common control units. One RATU is available per system to support a maximum of four Attendant Consoles per system with RCTUC/D or RCTUE/F, two with RCTUBA/BB, (any combination of PC or conventional consoles).

CO Line PCBs

A summary of Strata DK station, CO line PCBs and feature subassemblies are listed in [Table 23 on Page 40](#).

Caller ID Interface Unit (RCIU2)

The RCIU2 is required, along with an analog ground/loop start CO line PCB, to provide the Caller ID feature. Caller ID is also known as CLID and is available at extra cost per line from the local Telco. It is sometimes known as a CLASS feature.

Each RCIU2 circuit receives and decodes telephone number and name information sent from the calling CO. Caller ID is available on analog loop start lines and analog ground start lines only. An RCIU2 circuit must be available with each RGLU2, RCOU/RCOS, PCOU or KCDU2 circuit that is to receive Caller ID. Built-in gas tubes help protect each RCIU2 circuit from lightning surges.

An RCIS subassembly PCB can be installed onto the RCIU2 to provide four additional Caller ID circuits.

Caller ID Interface Subassembly (RCIS)

The RCIU2 comes equipped with four Caller ID circuits; an RCIS subassembly PCB can be installed onto the RCIU2 to provide four additional Caller ID circuits. Hence, an installed RCIU2/RCIS can provide a maximum of eight Caller ID circuits per cabinet slot. Built-in gas tubes help protect each RCIU2/RCIS circuit from lightning surges.

Loop Start CO Line Interface Unit (RCOU)

The RCOU in its basic configuration has four analog loop start CO line circuits, connecting to the public telephone network.

Each RCOU line can be programmed for DTMF or Dial Pulse signaling and has a switch to control potential excess volume that can be created by a nearby PBX or CO.

An optional RCOS subassembly can be attached to the RCOU for four more loop start lines. Each line can be programmed for DTMF or Dial Pulse signaling. Built-in gas tubes help protect each circuit from lightning.

Loop Start CO Line Interface Subassembly (RCOS)

The RCOS can be attached to the RCOU to provide four additional analog loop start CO line circuits. Each RCOS line has all of the features that are available with the RCOU lines.

Ground/Loop Start Interface CO Line Interface Unit (RGLU2)

The RGLU2 provides four analog CO line circuits which can be configured individually for ground start or loop start. Ground start should be used for applications requiring disconnect supervision, such as AA/Voice Mail, or ACD.

The RGLU2 also provides ring detection, dial outpulsing, Hold, and CO line flash signal. Each RGLU2 line can be programmed for DTMF or Dial Pulse signaling and has a switch to control potential excess volume that can be created by a nearby PBX or CO. Built-in gas tubes help protect each circuit from lightning.

Direct Inward Dialing Interface Unit (RDDU)

The RDDU provides four analog DID lines, each of which is assigned a single office code along with a block of extension numbers. Each extension number is programmed to ring a [DN] selected in system programming. This enables calls over the same line to be routed to different stations.

Each DID line can be set for either Wink Start or Immediate Start. DID lines can also support DNIS and/or ANI. An optional K5RCU or K5RCU2 (DK40i) or RRCS (DK424) tone receiver PCB is required for DTMF DID operation. Rotary DID signaling ability at 20 pps is a standard feature. An external protector is required for each line.

Tie Line Unit (REMU)

The REMU has four analog circuits for E & M Type I or Type II signaling, Immediate Start or Wink Start Tie lines. A choice between 2- or 4-wire transmission is available as a jumper-plug option.

Tie lines can also support DNIS and/or ANI. An optional K5RCU or K5RCU2 (DK40i) or RRCS (DK424) tone receiver PCB is required for DTMF Tie operation. An external protector is required for each line. REMU Tie lines are two-way and can be used for incoming and outgoing calls.

T1/DS-1 Interface Unit (RDTU2) (DK424 only)

The RDTU provides either 8, 16 or 24 digital voice channels that can be individually configured for ground start CO line operation, loop start CO line operation, DID/DOD line operation (with hookflash) or Tie line operation. The number and type of channels for each RDTU installed is assigned in system programming. All RDTU line types are two-way and can be used for incoming and outgoing calls.

Any RDTU, DID/DOD, or Tie channel can be configured in system programming to receive DNIS and/or ANI information from long distance carriers.

The RDTU is available for systems operating with a RCTUBA/BB, RCTUC/D or RCTUE/F common control unit. The RDTU normally requires the installation of a Channel Service Unit, which is not supplied by Toshiba. RDTU T1/DS-1 digital voice channels can be configured for SF or ESF format and either AMI or B8ZS line coding (see [Table 23](#)).

The new RDTU2, installed in a DK424 Release 4.0 system, supports the hook flash capability. “SuperTrunk” requires hook flash operation on T1 two-way DID/DOD lines. The RDTU1 can be upgraded to support hook flash.

In most locations within the U.S., network connection using RDTU2 requires a dealer-supplied, UL-listed external CSU or in Canada, a CSA-certified CSU.

ISDN Primary Rate Interface Unit (RPTU) (DK424 only)

The Primary Rate Interface Unit is a 24-channel PRI card, which provides 1 data (control) channel and 23 bearer channels (available in Release 4.0). All B channels appear and program as CO lines in the DK424 system and can be individually configured for local service, FX, WATS, DID, Tie, etc., service operation. Network connection using the RPTU requires a dealer-supplied, UL-listed, external CSU in most locations in the U.S. In Canada, the CSU/DSU must be CSA certified.

The RPTU is supported by the RCTUBA3/BB4, RCTUC3/D4 and RCTUE3/F4. See “[ISDN Primary Rate Interface \(PRI\)](#)” on [Page 73](#) for more information.

ISDN S/T-type Basic Rate Interface Unit (RBSU)

The Basic Rate Interface (BRI) Unit provides two BRI S/T circuits. Each circuit provides two simultaneous voice and/or data connections with a single interface. BRI uses the 2B+D transmission format which is defined as two 64-kbps bearer channels and one 16-kbps data (control) channel. The D channel carries call setup control data.

The RBSU BRI circuits can be connected to ISDN BRI network lines and/or ISDN S-type Terminal Equipment (TE-1) or Terminal Adapters (TA) on the station side.

The RBSU/RBSS BRI circuits that are configured for the station side provide a passive bus that enables up to two TE1 and TA devices to be connected to one BRI circuit. When multiple TE1 and TA devices are installed on a singled RBSU/RBSS BRI circuit, the devices must share or contend for that circuit’s two B channels.

A maximum of two simultaneous voice and/or data calls are allowed between all devices connected to the same BRI circuit. The contention rule for the two BRI B channels is first come, first serve. Network connections using BRI S/T type interface also require a dealer-supplied, UL-listed, external Network Terminal (NT-1) device. In Canada, the NT-1 must be CSA certified.

Note RBSU/RBSS will be available with DK424 and DK40i Release 4.1.

Basic Rate Interface Subassembly (RBSS)

The RBSS attaches to the RBSU to provide two additional BRI S/T type circuits that can be used for station-side connections only. An RBSU with the RBSS subassembly provides four BRI circuits in one card slot.

RBSU/RBSS stations can be voice and/or data devices, such as ISDN telephones and Terminal Adapters, that support the standard S-type interface. Each RBSU/RBSS circuit provides two B channels, plus one D channel and reduces the system’s basic capacity by two station ports and two CO lines. See “[ISDN Basic Rate Interface \(BRI\)](#)” on [Page 73](#) for more information.

Note RBSU/RBSS will be available with DK424 and DK40i Release 4.1.

ISDN U-type Basic Rate Interface Unit (RBUU) (DK424 only)

The Basic Rate Interface Unit provides two Basic Rate Interface (BRI) “U” circuits. Each circuit provides two simultaneous voice and/or data connections with a single interface. BRI uses the 2B+D transmission format which is defined as two 64-kbps bearer channels and one 16-kbps data (control) channel.

Note RBUU/RBUS will be available with Release 4.2.

Basic Rate Interface Subassembly (RBUS)

The RBUS attaches to the RBUU to provide two additional BRI “U” circuits that can be used to connect to Network BRI lines and/or station-side connections only. An RBUU with the RBUS subassembly provides four BRI “U” circuits in one card slot.

RBUU/RBUS stations can be voice and/or data devices, such as ISDN telephones and Terminal Adapters, that support the standard U-type interface. Each RBUU/RBUS circuit provides two B channels plus one D channel and reduces the basic system capacity by two CO lines and two station ports. See “ISDN Basic Rate Interface (BRI)” on Page 73 for more information.

Enhanced 911 CAMA Trunk Interface Unit (RMCU/RCMS) (DK424 only)

The RMCU/RCMS PCBs provide up to four CAMA trunk circuits. The RMCU/RCMS eliminates the need for connection of adjunct terminal adapter equipment to E911 CAMA trunks. Available for DK424 in Release 4.0. Also, see note below RCMS.

CAMA Trunk Subassembly (RCMS)

One RCMS subassembly attaches to the RMCU to provide two CAMA trunk circuits. A second RCMS can be added to provide four CAMA trunk circuits. Available in a future release.

Note The RCMS is ordered separately from the RMCU, but it must be installed on the RMCU to provide CAMA trunk interface.

Summary of PCBs and Subassemblies

Table 23 provides a summary of the universal slot PCBs and available subassemblies.

Table 23 PCB Circuits, Interface Options and Connectors

PCB	Subassembly	Circuits	Interface Options	Connector
RPTU		(DK424 only) 1 circuit/ISDN PRI (23 B channels/1 D channel)	POTS FX Tie (senderized) Tie (cut through) OUTWATS (intra-LATA) OUTWATS (inter-LATA) InWATS	RJ48C or RJ48X ISDN TIA-568A
RBSU		2 ISDN BRI S/T point circuits (NT or TE). Each circuit is 2B+1D. (Host for the RBSS)	Network and/or station side	RJ45, ISDN TIA-568A
attaches to RBSU	RBSS	2 ISDN BRI, S point circuits (2B+D each)	Station side only 1 RBSS subassembly per RBSU	RJ45, ISDN TIA-568A

Table 23 PCB Circuits, Interface Options and Connectors (continued)

PCB	Subassembly	Circuits	Interface Options	Connector
RBUU		(DK424 only) 2 ISDN BRI, U point circuits (2B+D each). Host for the RBUS. (Release 4.2)	Network and/or station side	RJ45, ISDN TIA-568A
attaches to RBUU	RBUS	2 ISDN BRI, U point circuits (2B+D each) subassembly for the RBUU. (Release 4.2)	Network and/or station side 1 RBUS subassembly per RBUU.	RJ45, ISDN TIA-568A
RDTU2		Applies to DK424 only. 1~8, 1~16, or 1~24 channels (lines), depends on system programming	Loop start lines Ground start lines Tie lines (wink or immediate) DID/DOD lines (wink or immediate)	2-pair amphenol RJ48M (All PCB amphenol connectors are female)
RMCU		2 E911 CAMA circuits with the 1 RCMS or 4 with 2 RCMSs	E911 CAMA lines	RJ11C modular
attaches to RMCU	RCMS	2 E911 CAMA circuits	Up to 2 RCMSs per RMCU for 4 CAMA lines max.	
REMU		4 Tie line circuits	E&M Tie lines 2- or 4-wire transmission Type I signaling Type II signaling Immediate start Wink start	REMU (8-wire modular jack) 2- or 4-wire/type I or II
KCDU		(DK40i only) 2 CO line circuits/ 4 digital telephone circuits	CO loop start lines Digital circuits same as PDKU, except no DDSS	RJ14C modular (CO Line circuits) 25-pair amphenol (digital phone circuits)
RCOU		4 CO line circuits (lines) With RCOS: 8 CO line circuits (lines)	CO loop start lines	RJ14C modular
attaches to RCOU	RCOS	Provides four additional Loop Start CO lines.	1 RCOS subassembly per RCOU	
RCIU2		4 circuits With RCIS: 8 circuits	Loop or Ground Start Lines with Caller ID. Requires: RCOU, RGLU2 or PCOU	RJ14C modular
attaches to RCIU2	RCIS	Used with RCOU/RCOS, PCOU, and RGLU2 CO line PCBs to provide 4 Caller ID circuits.	1 RCIS subassembly per RCIU2	
RDDU		4 DID circuits	DID Lines	RJ14C modular
RGLU2		4 line circuits	Loop or ground start lines	RJ14C modular
PIOU, PIOUS, PEPU, RSSU		A PIOU or PIOUS can use an IMDU	ACD/SMIS (DK424 only, except RCTUA) SMDI for Voice Mail SMDR printer or call accounting machine PC or maintenance terminal (local or remote)	25-pair amphenol (PIOU or PEPU) Spring clip terminal (PIOUS) Two 3-pair modular (TTY/SMDR/SMDI/SMIS) (All PCB amphenol connectors are female)
attaches to PIOU and PIOUS	IMDU		Provides remote maintenance 300 bps or 1200 bps full-duplex modem for DKAdmin or DKBackup. 1 per PIOU/PIOUS.	None

Table 23 PCB Circuits, Interface Options and Connectors *(continued)*

PCB	Subassembly	Circuits	Interface Options	Connector
RSTU2		8 standard telephone circuits	Standard telephones Voice mail ports Off-premises stations Other similar devices Alternate BGM source Auto Attendant digital announcer Message Waiting lamp (RSTU2 only) Fax machines ACD Announcer Strata Airlink wireless telephones	25-pair amphenol (All PCB amphenol connectors are female)
attaches to RSTU2 and RDSU	R48S	48 volt circuit for up to 8 standard telephone circuits	Optionally interfaces to the RSTU2 and RDSU to extend loop length of standard telephones from 600 ohms to 1200 ohms.	None
RDSU		Without RSTs: 2 standard telephone/ 4 digital telephone circuits With RSTs: 4 standard telephone/ 4 digital telephone circuits	Digital: same as PDKU, except no DDSS console Standard: same as RSTU (standard Message Waiting not available)	25-pair amphenol
attaches to RSTU2 and RDSU	RSTS	Provides two additional standard telephone circuits	1 maximum per RDSU	None
PESU		2 standard telephone circuits/ 4 electronic telephone circuits (standard/electronic telephone ports)	Standard: same as KSTU2 Electronic: same as PEKU, except PESU does not support HDSS console	25-pair amphenol
RATU		(DK424 only) 4 PC attendant PC console circuits	PC attendant console Conventional attendant console	25-pair amphenol
PDKU2		8 digital telephone circuits	Digital telephones (with or without RPCI-DI, DVSU, DADMs, or digital cordless telephone) Stand-alone digital cordless telephone DDSS console PDIU-DS DDCB	25-pair amphenol
Stratagy DK		2, 4, 6, or 8 VM ports All of the above Stratagy DK systems use 8 station ports in the DK40i and DK424 software	None	None
PEKU		8 electronic telephone circuits	Electronic telephones HDSS console Alternate BGM source EOCU PCB for OCA External conference amplifier HDCB	25-pair amphenol (All PCB amphenol connectors are Female)

Table 23 PCB Circuits, Interface Options and Connectors (continued)

PCB	Subassembly	Circuits	Interface Options	Connector
attaches to PEKU or PESU	EOCU	Provides Speaker OCA path for 8 circuits on PEKU or 4 circuits on PESU. (Handset OCA is not available on EKTs.)	1 for PEKU or PESU that supports Speaker OCA	
RSIU (DK424 only)		Up to 4 interface ports when installed with the optional RSIS or RMDS piggy-back PCBs.	ACD/SMIS SMDI for voice mail SMDR printer or call accounting machine PC or maintenance terminal (local or remote)	One 3-pair modular (TTY/SMDR/SMDI/SMIS)
attaches to RSIU	RSIS, RS-232 interface RMDS (Modem/RS-232) (DK424 only)	Up to 3 RSISs ...or 1 RMDS and 2 RSISs per RSIU	Provides up to four interface ports (RS-232 and modem) for system interface with: RMDS (1200 or 2400 bps) Voice Mail SMDI ACD/SMIS SMDR Local or Remote Maintenance for DKAdmin or DKBackup PC.	One 3-pair modular per RSIS (RS-232), RMDS (Modem/RS-232)
RWIU		4 RJ11 jacks to support 4 Strata AirLink Integrated Base Stations	Digital Wireless Handsets: same as PDKU, except no DDSS console, Stand-alone cordless telephone, PDIU-DS, or DDCB	None

Option Interface PCBs

For a list of optional interfaces, see [Table 24](#) (DK40i) and [Table 25](#) (DK424).

Option Interface Unit (PIOU)

The PIOU provides interfaces for Paging (Amplified, Unamplified, and Zone), SMDR, SMDI for Voice Mail integration, SMIS for ACD, DKAdmin Interface for on or off-site maintenance, an Alarm sensor, and a Remote Maintenance Modem subassembly (IMDU) that allows the system to be programmed from an off-site DKAdmin PC.

- ♦ **DK40i** – the PIOU PCB's three-watt or non-amplified 600 Ω paging output is not used since paging is supported by the Base KSU paging interface.

- ♦ **DK424** – the PIOU provides two-relay contact pairs. One of the contact pairs can be set for control of a customer-provided door lock or control of a MOH source. The other relay pair can be configured to mute BGM while the page feature is being activated or for the Night Relay function.

Simplified Option Interface Unit (PIOUS)

The PIOUS has most of the PIOU’s features, including SMDR output and the TTY output port interface and IMDU. It also provides flexible relay contacts and an Unamplified Page output. It does not provide Amplified or Zone Paging.

Remote Maintenance Subassembly (IMDU)

The IMDU is an optional modem that connects to a PIOU or PIOUS to link the system to off-site programming and maintenance equipment, such as a DKAdmin PC. The IMDU has an internal maintenance channel and does not require a dedicated CO line or station port. Data transmission speed can be set at 300 or 1200 bps full duplex.

Table 24 DK40i Interface PCB Options

Interface Options ¹	RSSU	PIOU	PIOUS	PEPU	TSIU	DK40i Base ²
Zone page interface (unamplified, 4 zones)		X				
Unamplified page output (single zone, 600 Ω, duplex)						X
Night transfer or Music-on-hold control relay		X	X	X		X
Door lock or external amplifier control relay		X	X	X		X
IMDU disables TTY output when piggy-backed onto PIOU or PIOUS cards		X	X			
Remote Maintenance using customer-provided external modem, StrataControl and/or DKAdmin PC (requires TTY output port)	X	X	X		X	
SMDR output (RS-232/6-wire modular connector)		X	X		X	
Alarm sensor		X	X			
Voice Mail SMDI (requires TTY output port)	X	X	X		X	

1. Amplified page output (single zone, 3 watts, 8 ohms) on the PIOU and PEPU is not available on the DK40i.

2. These functions are standard (built-in) to the DK40i Base KSU.

External Page Interface Unit (PEPU)

The PEPU is a reduced version of the PIOU and PIOUS, providing most of the Paging and Relay Contact options offered by these other optional PCBs.

Single Serial Interface Unit (RSSU)

The RSSU contains one RS-232 serial port for connecting an SMDI, SMIS processor, DKAdmin/DKBackup PC or external modem.

The RSSU provides a cost-effective alternative to the PIOU or PIOUS when only one other serial I/O port is needed, or when the other features of the PIOU or PIOUS are not required. The RSSU has a fixed speed of 1200 bps. It does not support SMDR, or the IMDU or RMDS modems.

- ♦ **DK40i** – one optional RSSU maintenance interface PCB can be used for connecting a maintenance PC or external modem (local or remote) to the DK40i.
- ♦ **DK424** – a maximum of three RSSU cards can be supported per DK424.

Table 25 DK424 Interface PCB Options

Interface Options	RSSU ¹	PIOU ¹	PIOUS ¹	PEPU	RSIU/RSIS ¹
Zone page interface (unamplified, 4 zones)		X			
Unamplified page output (single zone, 600 ohms, duplex)		X	X	X	
Amplified page output (single zone, 3 watts, 8 ohms)		X		X	
Night transfer or Music-on-hold control relay		X	X	X	
Door lock or external amplifier control relay		X	X	X	
Alarm Sensor		X	X		
Remote maintenance modem subassembly (IMDU or RMDS) (disables TTY output when they are piggy-backed onto the PIOU/PIOUS or RSIU/RSIS cards) ²		X (IMDU)	X (IMDU)		X (IMDU)
Remote Maintenance using customer-provided external modem (requires TTY output port) ²	X	X	X		X
SMDR output (RS-232/6-wire modular connector)		X ³	X ³		X
MIS for ACD (requires TTY output port) ^{2, 4}	X	X	X		X
Voice Mail SMDI (requires TTY output port) ²	X	X	X		X
StrataControl and/or DKAdmin PC (requires TTY output port) ²	X	X	X		X

1. PIOU, PIOUS, and RSSU each provide one TTY port which can be flexibly programmed for the features marked with X. RSIU/RSIS can provide up to four flexible TTY/SMDR ports.
2. Maintenance modem, ACD/SMIS, Insight DK, Voice Mail, SMDI and DKAdmin PC Interface each require a separate TTY output. PIOU, PIOUS, and RSSU provide one TTY output each. RSIU with RSIS PCBs provides up to four TTY outputs.
3. SMDR output will function simultaneously on the same PIOU or PIOUS with one of the following: DKAdmin, remote modem, SMIS for ACD, Insight DK, or SMDI features.
4. Insight DK, Call Center Viewer and SMIS for ACD requires that the system processor (RCTU PCB) must be equipped with an RKYS3 or higher feature key.

Serial Interface Unit (RSIU, DK424 only)

The RSIU provides up to four interface ports that allow the Strata DK424 system to connect to the following:

- ♦ Voice Mail system with RS-232 SMDI
- ♦ ACD/SMIS system or Call Center Viewer
- ♦ SMDR printer or call accounting machine
- ♦ DKAdmin/DKBackup running on a PC as a maintenance terminal (locally or remotely)

The RSIU, which comes standard with one port, can be equipped with up to three more optional RS-232 ports (total of four RS-232 ports). The Single Interface Subassembly (RSIS) piggy-backs onto the RSIU PCB to provide the optional ports. One of the serial ports can be an internal modem. An optional 2400 bps built-in Modem Subassembly (RMDS) can be added onto the RSIU.

The maximum allowed combined speed of all four channels is 9600 bps. All four channels of the RSIU connect directly to the RCTU processor via a short ribbon cable. The RSIU must be positioned in the first universal slot of the Base Cabinet.

RMDS (DK424 only)

The optional RMDS modem mounts on an RSIU and can function either as a remote maintenance modem to provide the same functions as the IMDU or as a direct RS-232 link to a DKAdmin/DKBackup PC COM port.

The function of the RMDS is set in system programming. Data transmission speed for the built-in modem function can be set at 1200 bps or 2400 bps via system programming.

This chapter discusses the current line of Strata DK telephones and peripherals that are compatible with DK14, DK40i and DK424.

The Strata DK40i and DK424 systems can also support all older Strata digital telephones and most Strata electronic telephones.

A large number of widely used and sophisticated features are available to Strata DK station users. Everyday features such as Call Transfer, Call Forwarding, Call Holding, and Call Pickup are executed with just the push of a button or a brief access code. LCD telephones offer more sophisticated features.

In addition to various operational features, the Strata DK also supports multiple [DNs], providing easy access to specific lines at the convenience of station users.

Toshiba Telecommunication Systems Division (TSD) does not provide ISDN station equipment, such as ISDN telephones, fax machines, and computer interface devices for high speed internet access or video conferencing. Toshiba does provide the interface circuit boards that support all of the above ISDN station equipment.

Digital Telephones

The Strata DK supports the latest line of Strata DKT2000-series digital telephones, which offer station users a number of useful features that are easy to access (see [Figure 15](#)).

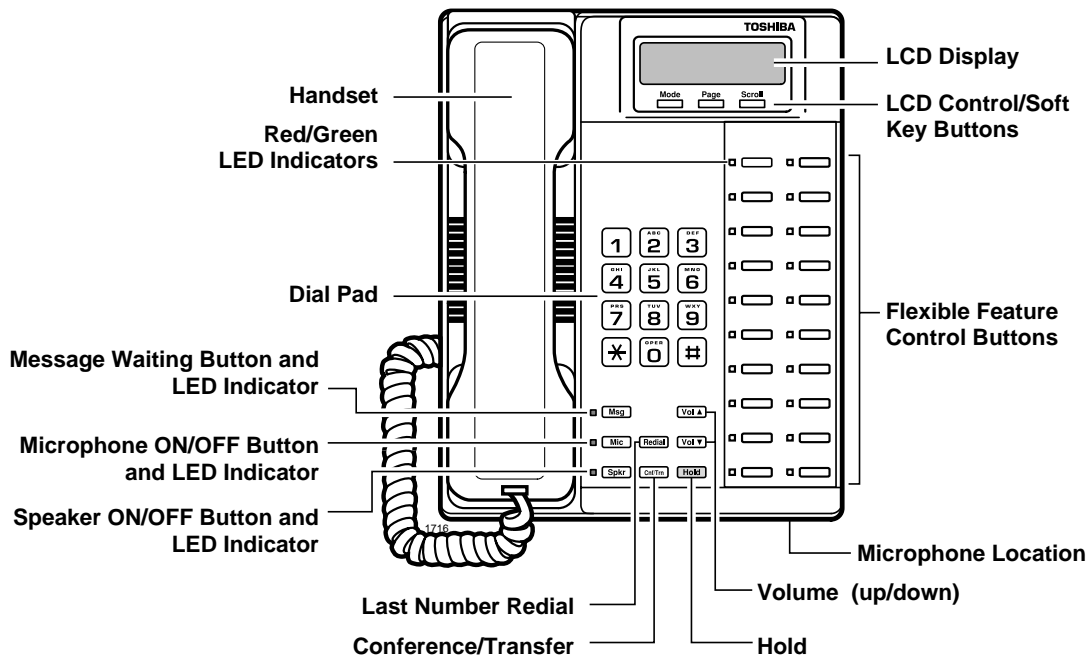

Figure 15 2000-Series Digital Telephone Buttons and Features

These telephones share a similar design and fit with a variety of office environments. The DKT2000-series are available in charcoal gray or ash white color in the following models:

DKT2010-H

The DKT2010-H is a 10-Button Digital Telephone with Handsfree Answerback.



DKT2020-S

The DKT2020-S is a 20-button Digital Speakerphone.



DKT2010-SD

The DKT2010-SD is a 10-Button Digital Speakerphone with Liquid Crystal Display.



DKT2020-SD

The DKT2020-SD is a 20-Button Digital Speakerphone with Liquid Crystal Display.



DKT2001

The DKT2001 is a Digital Single Line Telephone. It looks similar to the existing 2000-series telephones, but it has a smaller footprint. It is narrower because there are no programmable buttons and no LCD.

The DKT2001 connects to same digital station port as other 2000-series digital telephones. This makes it compatible with all Strata DK and Perception systems that support digital station ports.



Features

The digital single line telephone supports many features of the other 2000-series digital telephones, including:

- ◆ Line button with a red LED. The Line button for the DKT2001 is the [PDN] on this telephone.
- ◆ Hold button
- ◆ Conference/Transfer button
- ◆ Message Waiting button with red LED
- ◆ Volume Up and Volume Down buttons
- ◆ One-way voice announce and handset OCA
- ◆ Supports most DKT features through the use of feature codes

There are some features of the other 2000-series digital telephones that the DKT2001 *does not* support:

- ◆ On-hook dialing
- ◆ Handsfree answerback.
- ◆ Speaker OCA
- ◆ Add-on module (DADM2020)
- ◆ Personal Computer Interface Unit (RPCI)
- ◆ Headset/loud ringing bell connection (HHEU)
- ◆ Redial button
- ◆ Programmable buttons or LCD

The digital single line telephone has many feature advantages over analog single-line telephones:

- ◆ Automatic Busy Redial
- ◆ Automatic Line Selection
- ◆ Background Music with station control
- ◆ Busy Override over Handset
- ◆ Exclusive Hold
- ◆ One-way voice announce and handset OCA

Liquid Crystal Display (LCD) Telephones

LCD telephones (DKT2010-SD and DKT2020-SD) provide a variety of calling and messaging information on an alphanumeric screen that displays up to two-lines of information, up to 16 characters per line. LCD telephones provide the features shown in [Table 26](#).

Table 26 LCD Features

Feature	Description
Alphanumeric Messaging	Station users can create alphanumeric messages that display on other station users' LCDs, including busy, called station, calling station, and group station messaging.
Automatic Number Identification (ANI)	Displays the telephone numbers of the calling party for incoming, transferred, and Call Forward calls.
Busy Lamp Field (BLF) Indication	Indicates the busy or idle status of all of the telephones in the system.
Call Duration	The time elapsed during an outside call displays.
Caller ID	The telephone number or name of the calling party displays on the ringing telephone for incoming, transferred, and Call Forward calls.
Call Park Orbits	When a call is parked, the orbit number displays. When multiple calls are parked, LCD station users can scroll through a list of parked calls.
CO Line Identification	Each line can be assigned a name which displays when station users answer or access lines. Names can be up to 16 characters long.
Date/Time of Day	The date and time displays when stations are idle.
Dialed Number Identification Service (DNIS)	Displays names of called parties which have been previously correlated with the system database of assigned DNIS numbers.
[DN] User Name/ Number	Station users can enter a name that displays on the station's LCD when idle, and appears on the LCDs of other calling stations when the station calls them. The called station's name also appears on the calling station's LCD. Names can be up to 16 characters long. If a name is not created for a station, the station's Primary Directory Number [PDN] displays in place of the name.
Feature Prompting Soft Keys	Soft keys are used as an alternative to access codes or feature buttons. Station users can access features by responding to LCD prompts.
Timed Reminders with Messaging	Selected station users can define up to five separate messages and have each message appear on their LCD at pre-scheduled times.
Speed Dial Memo Directory Dialing	Selected station users can enter 12-character names for each of their Station (Personal) Speed Dial numbers. They can call any of these numbers by scrolling through the directory on the LCD, selecting the desired name, and pressing a line access button. LCD users can also scroll the system common speed dial directory.

Speakerphones

The DKT2010-SD, DKT2020-S, and DKT2020-SD models enable users to make both internal and outside calls without lifting the handset (see [Table 27](#)).

Table 27 Speakerphone Features

Feature	Description
Handsfree Answerback	All DKT2000-series telephones enable users to answer internal calls without lifting the handset.
Handset OCA	Enables you to speak through the handset of an off-hook, busy digital phone.
Flexible Buttons	All DKT2000-series telephones have flexible buttons which can be assigned to access features or CO lines. The DKT2010-H and the DKT2010-SD both have 10 flexible buttons, and the DKT2020-S and the DKT2020-SD have 20. LEDs can be red or green depending on conditions.
Fixed Buttons	All DKT2000-series digital telephones have fixed buttons with red LEDs which are permanently dedicated to the features noted below:
Msg	The Message button is used to turn on the Message LED of a called station that is busy or that does not answer. Users can press Msg to call back the station or voice mail device that left the message.
Mic	The Microphone button cuts off the microphone during speakerphone operation to enable private office conversations. Also used to enable handset OCA talkback mode.
Spkr	The Speaker button is used to turn the speaker on and mutes handset microphone for group listening. It also disconnects on-hook dialing calls.
Redial	The Redial button is used to redial the number last dialed from the station.
Cnf/Trn	The Conference/Transfer button is used to set up the Conference and Transfer features.
Vol	The Volume up/down button provides independent control of the handset, speaker, and ring volumes.
Hold	The Hold button places internal [DN] and outside calls on hold. Can also be used to place calls on Exclusive Hold.

Peripherals

The Strata DK supports several types of stations and customer-supplied peripheral devices, such as attendant consoles, Direct Station Selection (DSS) consoles, door phones for visitor screening, a music source for MOH, a speaker for BGM and Paging, Toshiba Strategy systems and Voice Processing (VP) for voice mail/auto attendant applications, and more (see Figure 16).

For information on the supporting PCB or data interface unit, refer to “Customer-supplied Peripherals and Interfaces” on Page 111.

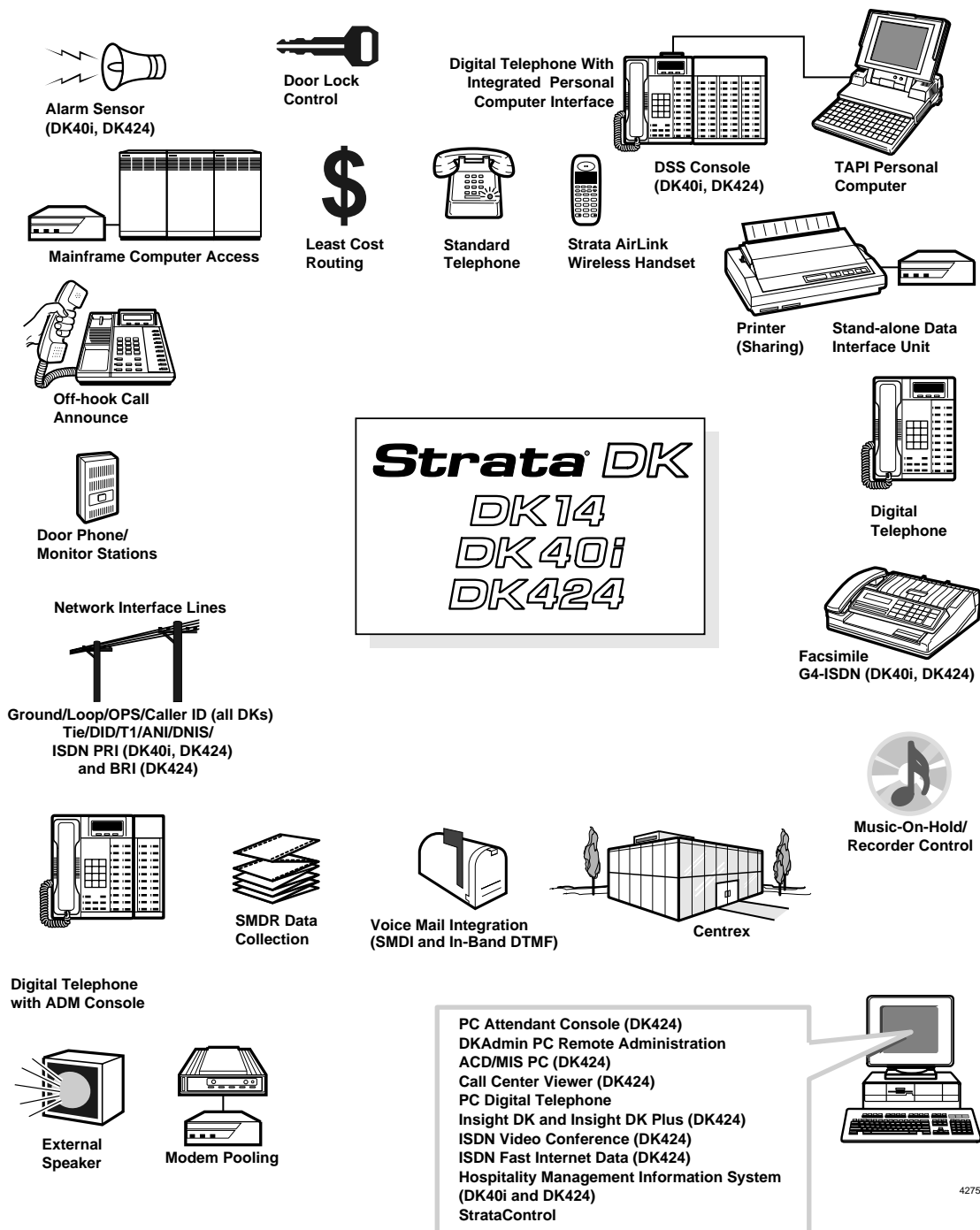

Figure 16 Strata DK Peripherals

Digital Telephone Upgrade Options

Digital telephones can be upgraded with the following options.

Digital Add-on Module (DADM)

The DADM adds 20 feature buttons to DKT2000-series telephones. These feature buttons can be assigned for CO line access, DSS, and Station or System Speed Dial. Directory Numbers or other functions, however, cannot be assigned to DADMs. Up to two DADMs can be attached to a telephone to provide 40 buttons to supplement the telephone's 10 or 20 buttons.

- ♦ **DK14** supports up to 8 DADMs
- ♦ **DK40i** supports up to 12 DADMs
- ♦ **DK424** supports up to 200 DADMs ([Table 34 on Page 89](#) for the capacities of different DK424 common control units)



Integrated PC Interface (RPCI-DI)

An optional RS-232 PC interface unit that replaces the normal telephone base and provides the telephone with simultaneous computer-telephone interface and voice/data features, without the need of a modem or an extra outgoing line.

RPCI-DI-equipped digital telephones can also be connected to a PC with Microsoft® Windows® TAPI applications. TAPI, or Telephony Application Programming Interface, applications enable the DK to provide “pop-up” screens on a PC that show information on the Calling or Called party.

Information such as ANI, DNIS, and Caller ID data is sent from the digital telephone/RPCI-DI to provide information for “pop-up” screens to the computer. The Telephone Service Provider Interface (TSPI) PC software is included with each RPCI-DI. For details on data interface specifications ([Table 43 on Page 116](#)).

Digital phones shared with the Cordless DKT-2004-CT telephone cannot use the RPCI.



Headset/Loud Ringing Bell Interface (HHEU)

The HHEU provides interfaces for both a headset and a loud ringing bell speaker. The headset must use a carbon microphone. (With the loud ringing bell feature, the speaker amplifies the ringing or voice announcement of an incoming call.) For details on data interface specifications ([Table 42 on Page 115](#)).

Speaker Off-hook Call Announce (DVSU)

DVSU-equipped digital telephones can receive Speaker OCA. This enables stations to receive internal calls over their speaker while on another call. DVSU is not required in a telephone to originate OCA calls or in a digital telephone that receives OCA calls via the handset or headset.

Stand-alone Data Interface Unit (PDIU-DS)

The PDIU-DS enables users to make switched data connections for modem pooling, printer sharing, and host/mainframe computer accessing. LEDs on the front panel of the PDIU-DS indicate the status of each call.



Cordless Digital Telephone (DKT2004-CT)

The Toshiba DKT2004-CT Cordless Digital Telephone brings mobility and productivity to office telephones. Greater call access cuts down on leaving messages and “telephone tag.” Its compact design enables the user to take it to many locations within the office complex.

Digital 900 MHz spread-spectrum technology provides nine simultaneous channels and represents state-of-the-art design and engineering. Spread-spectrum technology provides clarity in unsurpassed range, several times greater than conventional analog cordless telephones.

Spread-spectrum technology also provides extremely secure communications between cordless digital telephones and their corresponding base stations within a given environment. Fully charged, the cordless digital telephone provides over 3 hours of talk time, and 42 hours standby. An extended operation battery is also available to provide over five hours of talk time.

The cordless digital telephone either attaches to a Toshiba DKT2000-series corded digital telephone or is used as a stand-alone. It provides many sophisticated Strata features:

- ♦ LCD provides information such as User Name, DNIS and Caller ID
- ♦ Four programmable buttons for feature, multiple line or feature access
- ♦ Headset jack (headset optional)
- ♦ Handset volume adjustment
- ♦ Conference/Transfer (**Cnf/Trn**) button
- ♦ **Hold** button
- ♦ Message Waiting LED and button
- ♦ 20 Speed Dial number memory (in addition to 40 station speed dials)



The DKT2004-CT Cordless Digital Telephone operates from the same digital station port on the PDKU2 as the DKT2000-series digital telephone which may or may not be attached. It is not compatible with receiving Group Pages or All Call Pages.

Strata AirLink Wireless Handset

The Strata AirLink Wireless handset, like the cordless telephone, is designed for mobility, reliability, and outstanding performance. Operating in the 1.9 GHz Unlicensed Personal Communication Service (UPCS) range, it represents state-of-the-art design and engineering.

The handset can access up to eight separate Strata AirLink wireless systems enabling movement from building to building, system to system.

It provides unsurpassed range, clarity, and fully-secured communications using a voice scrambling algorithm.

The handset uses one Nickel Metal Hydride (NiMH) battery. When fully charged, the battery provides up to 4 hours of talk and 40 hours of standby time.



Features

The handset is equipped with 12 handset volume adjustments (plus a silent mode), 8 ring levels, and a lockable dial pad. Seventy internal alphanumeric Speed Dial memory locations enable Speed Dialing by name or number.

The handset has an LCD that shows an idle message, date, call duration, and icons. The icons represent these conditions:

- ◆ Off-hook or ringing
- ◆ Battery strength
- ◆ Alpha mode
- ◆ Signal lock and strength

It also has standard built-in buttons that perform these specific functions:

PWR – turns the power ON and OFF

FLSH – performs hookflash functions

FCN – enables features with the use of other buttons; for example, Call Forward, Transfer, Speed Dial, and Conference

▲/▼ – adjusts volume and scrolls through menu options

ABC – toggles handset between alpha and numeric modes

RCL – recalls numbers stored in memory

STO – stores Speed Dial numbers/names and the idle message

CALL – places the handset off-hook to enable calling

END – places the handset on-hook and exits from RCL, FCN, STO, and ABC modes

CLR – erases one or more digits in the display

***▲** – scrolls backwards through the Speed Dial list

#▼ – scrolls forward through the Speed Dial list and locks/unlocks the dial pad

PC Digital Telephone (PC-DKT)

Using Windows, the PC Digital Telephone (PC-DKT) application functions as an independent telephone. The PC-DKT enables you to make and receive calls using the Windows Virtual Telephone Display on your PC screen, using your PC's mouse and/or keyboard. A Toshiba digital desk telephone can be connected for backup or for speakerphone use. It's automatically activated when you close the PC-DKT application or when your computer is turned off.

The PC-DKT software runs in the background while you work on other Windows applications. You can set it to appear when calls arrive and when you want to make a call, or keep it displayed on top of all active applications. You can also use the PC-DKT with a Toshiba Cordless Digital Telephone and switch between them at the touch of a button - even during a call.

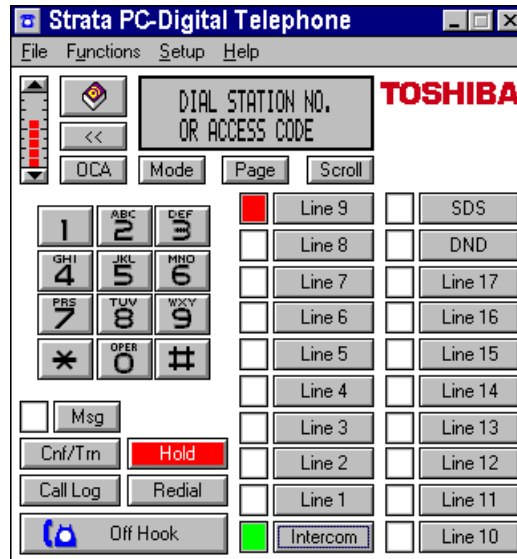

The PC-DKT provides all the features of a Toshiba LCD Digital Telephone while giving you these advanced features:

- ♦ **StrataBase directory** stores frequently called numbers and other contact information. Speed-dial directly from the database, and easily find specific information with the Search feature.
- ♦ **Call logging** tracks time, date, duration, destination, and Caller ID of all incoming and outgoing calls.
- ♦ **Voice mail access panel** lets you conveniently operate voice mail with user-definable buttons on screen.
- ♦ **Analog port** enables you to connect a speakerphone, cordless phone or other external device, or if you choose, send faxes and data from your PC telephone line through the Strata DK system.
- ♦ **Customize ring tones** to identify internal, external, recall, and emergency calls. It also can play separate sound wave (.WAV) tones to give each telephone line its own ringing sound (sound card required).
- ♦ **Call recording and playback** enables you to store recorded calls as sound wave (.WAV) files, play them back, and attach them to other applications (sound card required).
- ♦ **On-line help** makes the PC-DKT easy to use.
- ♦ **Account code calling** becomes an automatic process for any call, simply by selecting the option.

PC Attendant Console (DK-PCATT)

Operators can process a heavy load of incoming calls quickly and efficiently using the Strata DK PC Attendant Console for Microsoft Windows. The console is not available for the RCTUA processor, DK40i or DK14. The console consists of the following items:

- ♦ Custom keyboard (DK-PCATT-KB)
- ♦ Handset and cradle (RATHC)
- ♦ Attendant Console Interface Unit (RATI) connected to an RATU PCB
- ♦ Special Toshiba-proprietary software

The following customer-supplied items are needed:

- ♦ An IBM-compatible personal computer (PC) with a 1.44 floppy disk drive and an additional COM port to attach to Toshiba RATI PCB
- ♦ Windows 3.1 software, or higher
- ♦ Color VGA monitor
- ♦ Windows graphics acceleration
- ♦ Mouse

Note Minimum requirements for the PC are a 100MHz Pentium® computer with 16MB of RAM (for Microsoft Windows 3.1) or 32MB of RAM for (Windows 95), and 200MB hard drive. The application uses up to 20MB on the hard drive. A tower PC, placed on the floor, is recommended over a desktop type for visibility. An internal or external modem is recommended with a third COM port.

The system supports up to four attendant consoles. Multiple consoles automatically sharing incoming call load on a call-by-call rotation basis. Features such as Overflow, Position Busy Mode, and Interposition Call Transfer add to the efficiency of multiple console applications.

Although designed to be a dedicated console, the PC can also be used for other Windows applications and serve as a multi-purpose work station.

The main screen, shown below, changes according to the status of the console.

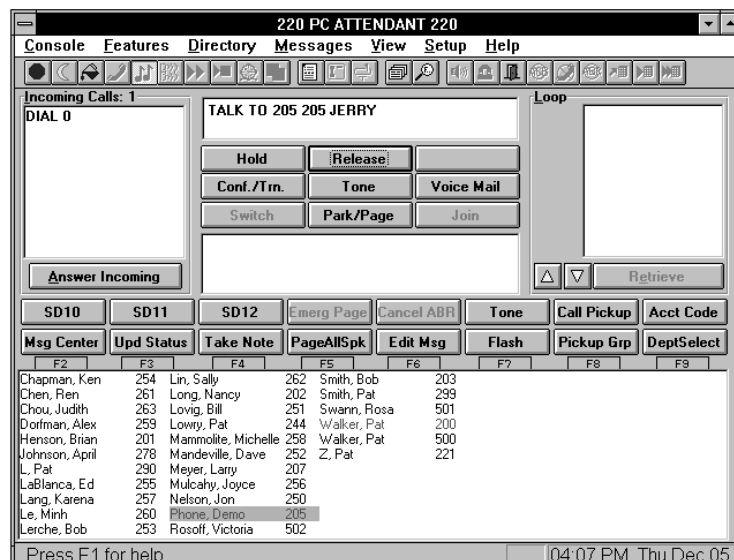

Various telephone and system parameters can be changed from the console, without a separate maintenance port. These include Telephone User Names and System Speed Dial numbers.

The PCATT provides a Name/Number search that works with automatic or manual call handling. Other powerful features for the PCATT include Call Answer Priority and Queuing, Direct Station Selection, dial pad DTMF signaling, Emergency Call ID, Flexible Programmable Keys, Loop Keys with Status Indication, keyboard or mouse operation, and headset or handset operation with volume control. See “[PC Attendant Console Features](#)” on [Page 102](#) for feature descriptions and [Table 36 on Page 108](#) for a list of features.

Direct Station Selection (DSS) Console

The DSS consoles are for system operators.

They operate alongside a digital or electronic telephone and have 60 buttons which can be programmed for DSS, CO line access, All Call Page, Night Transfer, and Station or System Speed Dial. DSS consoles do not have their own [DNs], since they are connected to a telephone.

Multiple consoles can operate with one DKT:

- ✦ **DK14** does not support DSS consoles
- ✦ **DK40i** supports up to three consoles
- ✦ **DK424** supports up to eight consoles ([Table 34 on Page 89](#) for DK424 DSS console capacities for various common control units)

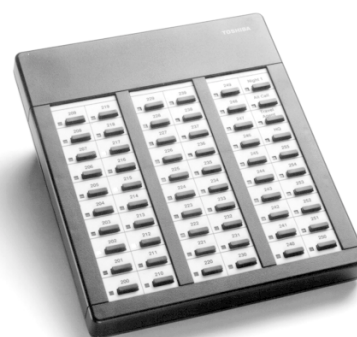

The DSS console uses LEDs to indicate call and feature status; the DDSS has dual red and green LEDs to help further define status. The DDSS console connects to the PDKU2. For details on data interface specifications ([Table 43 on Page 116](#)). The older electronic HDSS console is also supported.

Door Phone (MDFB)

MDFBs are often used with a door lock to screen building visitors. Door phones also can operate as a “hot line.” For example, a door phone can be used for calls between an office and a warehouse (requires DDCB).

- ✦ **DK14** can have up to 6 door phones
- ✦ **DK40i** can have up to 9 door phones
- ✦ **DK424** can have up to 12 door phones (see [Table 34 on Page 89](#) for MDFB capacities for various common control units)



Door Phone and Lock Control Unit (DDCB)

The DDCB can support as many as three door phones (MDFBs) or two door phones (MDFBs) and one door lock and connects to designated telephone circuits.



External Speaker (HESB)

The HESB is a multi-functional, external, six-inch speaker unit with a built-in three-watt amplifier. It can be used as a paging speaker, an amplified talkback speaker, or a telephone's Loud Ringing Bell.

Toshiba Strategy and Strategy DK Processing

The Strata DK can operate with Toshiba Strategy and Strategy DK voice processing systems, which provide a number of helpful features.

The DK14, DK40i and DK424 also support SMDI voice mail integration (see [“Simplified Message Desk Interface \(SMDI\)”](#) on [Page 80](#)). Refer to the appropriate Strategy literature for details. For Strategy voice mail processors, a standard telephone PCB is also required (QSTU2, KSTU2, RDSU, RSTU2).

The Strata DK supports in-band DTMF voice mail integration for all of the above voice mail systems and requires DTMF receivers:

- ♦ **DK14** requires the QRCU3 for DTMF voice mail integration.
- ♦ **DK40i** requires the DK40i Expansion KSU for Strategy DK voice mail. The K5RCU3 is required for DTMF voice mail integration. The Strategy DK does not require a KSTU2, RDSU or RSTU2; it acts as an RSTU2 in the Strata DK KSU slot.
- ♦ **DK424** requires the RRCS for DTMF voice mail integration.

Cabling and Connectors

Strata DK uses industry standard cabling and connectors to interface with lines, stations, and peripherals ([Table 39 on Page 112](#)).

Stations use standard twisted-pair cabling to connect to the system via the MDF. Digital and standard telephones require just one pair-cabling, or two pair, if equipped with DADM, RPCI or DVSU. Electronic telephones need two-pair cabling or three-pair for Speaker OCA.

Station PCBs connect to stations and peripherals with a 25-pair Amphenol connector via the MDF. CO, DID, and Tie line circuits interface with the public telephone network via modular connectors.

Peripheral devices such as SMDR, DKAdmin maintenance PC, etc., are connected to the interface PCBs (TSIU, RSIU, PIOU, etc.) with three-pair (six wires) modular cords and the Toshiba PPTC9 or PPTC RS-232-to-modular adapters.

The Strata AirLink Wireless Telephone system configured to standard ports (RSTU2) connects to all Strata DK systems using the Base Station Interface Adapters (BSIAs) and one or two Base Stations.

The Strata AirLink Wireless Telephone system configured to digital ports interfaces to the DK40i and DK424 (standard cabling and connectors) using the proprietary RWIU PCB. The RWIU uses industry standard RJ11 jacks to support up to four Base Stations. Multiple RWIUs can be installed to increase the capacity of the wireless system.

Station and Peripheral Specifications

For more information on Station and Peripheral Specifications, refer to these tables in the Appendix.

- ♦ [Station Loop Requirements \(Table 39 on Page 112\)](#)
- ♦ [Station Dimensions \(Table 40 on Page 113\)](#)
- ♦ [System Tones \(Table 41 on Page 114\)](#)
- ♦ [Subassemblies for Toshiba Telephones \(Table 42 on Page 115\)](#)
- ♦ [Data Interface Specifications \(Table 43 on Page 116\)](#)

This chapter provides descriptions of system and station features for the DK14, DK40i and DK424, in alphabetical order. These features apply to all of these systems, except where noted.

This chapter includes these sections:

- ♦ System Features
- ♦ Station Features
- ♦ PC Attendant Console Features (DK424 only)

System Features

This section describes features that are available on a system-wide basis. See [Table 32 on Page 88](#) for a list of system features.

Abandoned Call Numbers

Automatic Number Identification (ANI) and Caller ID calls that ring but are abandoned before they are answered can be stored in system memory. LCD telephone and attendant console users can display and Auto Dial the “abandoned call” ANI and Caller ID numbers.

- ♦ **DK14** and **DK40i** can store up to 200 ANI and Caller ID abandoned call numbers
- ♦ **DK424** can store up to 2,000 ANI and Caller ID abandoned call numbers

For DK14/DK40i/DK424, stations can be programmed to store from 0 to 100 abandoned call numbers in increments of 10.

Account Codes (Forced/Voluntary/Verified)

Account Codes provide a method of tracing and categorizing CO line calls on the SMDR report. They may even be used to temporarily change a restricted station's class of service to allow long distance calling after an Account Code is entered.

Account Codes may be required before dialing calls (Forced) or optionally entered during calls (Voluntary). Codes can be as long as 15 digits and can be verified or nonverified. If a printer is connected to the system, a record of each Account Code prints out on the SMDR report.

Note The 911 emergency number and two other optional customer-designated numbers (up to four digits long) can be assigned to bypass Forced Verified Account Code requirements.

Alarm Sensor (DK40i and DK424 only)

Both the PIOU and PIOUS option interface PCBs have a sensor that can be connected to a customer-supplied alarm system. If the alarm is activated, the sensor triggers a loud alert tone to all digital and electronic telephones. Any station programmed with an \$ODUP button can turn off the alert tone.

Alternate Answer Point

Users can answer a transferred outside line call from any station that has the /LQH button or a Secondary [DN] for the destination station.

Amplified Conference Interface

Provides interface for a customer-supplied amplifier to improve low volume levels due to losses on some CO lines. The amplifier is not dedicated to certain CO lines (it is shared by all CO lines) and automatically connects to calls that include two CO lines: for example, DISA, conferencing and external call forward.

This amplifier provides a louder sound level on these types of calls and requires two circuits on a PEKU or PESU PCB installed in the Strata DK per amplifier. A maximum of two (DK40i) or four (DK424) amplifiers per system can automatically connect to any two CO line conference. This feature is available for the Strata DK40i and DK424.

Auto Attendant (Built-in)

The built-in AA feature acts as an operator that automatically directs incoming calls to stations. Strata DK provides a built-in AA feature via optional feature upgrade keys: QKYS (DK14), KKYS (DK40i), RKYS1~3 (DK424).

Callers who dial in to assigned Strata DK AA lines can receive a dialing prompt menu, such as, "Dial 5 for Sales, dial 6 for Tech Support." When the caller dials the digit, the call routes to a [DN], ACD group, or Distributed Hunt group (assigned in system programming).

AA can be programmed to answer CO line calls immediately or with a delayed ring option. AA can pick up unanswered calls that ring for either 12 or 24 seconds at selected stations. An unlimited number of CO lines can be assigned for built-in AA. Built-in AA applies to loop and ground start CO lines only; it does not answer Tie or DID line calls.

Built-in AA enables access to outgoing lines via DISA, which should be security protected with account codes and/or a DISA security code.

The AA feature requires customer-provided digital announcement device(s) and optional QRCU3 (DK14), K5RCU (DK40i) or RRCS (DK424) tone receiver PCBs. Callers can be connected to one digital announcer simultaneously. One DTMF receiver is needed per caller.

- ♦ **DK14** enables up to three caller connections
- ♦ **DK40i** enables up to five caller connections
- ♦ **DK424** allows up to 24 caller connections

Auto Attendant is licensed by Dytel, Inc. under United States Patent No. 4,975,941.

Automatic Call Distribution (ACD) (DK424 only)

With an optional feature upgrade key (RKYS2~3) connected to an RCTU processor, stations in the DK424 can be arranged in ACD groups. Such an arrangement enables incoming calls over a CO line to be distributed among a group of ACD Agents. This is ideal where a number of staff members receive the same type of calls, since calls can be automatically distributed.

Incoming calls that are not directly connected to Agents wait in queue for the first available Agent in the called group. While waiting, callers hear programmed announcements and music at designated intervals to encourage them to remain on hold. This feature requires a customer-provided, digital announcement device(s) and music source.

When the number of ACD calls waiting in queue reaches a programmable threshold, calls can overflow to another ACD group or destination such as a Distributed Hunt (DH) group.

The ACD feature also enables supervisor stations to provide ACD Agents with call assistance and call monitoring. ACD Supervisor LCD telephones can display ACD group status, individual Agent status (available/unavailable, on an ACD call, etc.) and Call Status (the number of calls in queue, longest call in queue, etc.).

Additionally, the RKYS3 feature key enables the use of a Call Center Viewer, SMIS, or Insight DK application. SMIS provides detailed supervisory monitoring of Agent calls (on a PC screen) and printed reports regarding an Agent's performance. Call Center Viewer presents real-time ACD Agent and Queue Status to multiple PC screens.

Insight DK (DK424 only)

The Insight DK and Insight DK Plus systems are full-featured ACD MIS tools for call center supervisors, providing user-defined supervisor displays, user-defined historical reports, electronic wall board connections, and inView LAN-based status display messaging.

Insight DK and DK Plus are Windows-based MIS software programs that work with PCs running Windows 95 (Vers. 4.00.950A, B, or C), Windows 98 or Windows NT® with Service Pack 3.

They both support external wallboard displays and scheduled reporting. The data collected can be exported for further processing using other report generator programs or spread sheets. They also support inView, which provides LAN-based status displays in a wallboard format on Agent's or Supervisor's PC screens. See the *Strata DK424 Call Center Solutions General Description* for more information.

ACD Feature capacities are listed in [Table 28](#).

Table 28 ACD Capacities

ACD	DK424		
	RCTUBA/BB	RCTUC/D	RCTUE/F
ACD/Insight DK and Insight DK Plus/SMIS/Call Center Viewer	Yes	Yes	Yes
ACD Groups	8	16	16
ACD Agent IDs ¹	200	256	256
ACD Music Interface Ports (1 per Group)	8	16	16
ACD Announce Interface Ports (3 per Group)	24	48	48

1. There are system limits for the number of simultaneous Agents depending on traffic. See the *Strata DK424 Call Center Solutions General Description* for details.

Automatic Number Identification (ANI)

LCD telephones can display the telephone number of the calling party for direct, incoming, transferred, and Call Forwarded calls. The telephone number can also be sent to an application computer or to voice mail.

The system supports ANI on analog or digital lines (T1 or ISDN PRI/BRI), DID and Tie lines, and provides the calling telephone number to answering parties. An optional tone receiver PCB (K5RCU for DK40i; RRCS for DK424) is required for ANI line operation. DK14 does not support ANI.

ANI is also known as Calling Number Identification Service (CNIS) on ISDN lines. CNIS operates the same as ANI on the DK424. ANI digits can be received independently or simultaneously with DNIS called number digits.

Calls received with DNIS digits can be routed to unique destinations for each DNIS number (see [“Dialed Number Identification Service \(DNIS\) \(DK40i and DK424 only\)”](#) on Page 68 and Table 29).

If ANI is received without DNIS, all ANI calls ring the same selected destination. ANI calls are calls can be routed to a unique destination for each system ringing mode (Day, Day 2, Night). All routing destinations except Intercept can be assigned by system programming to change according to the time of day (see [“Day/Night Modes”](#) on Page 67).

In the DK40i, each ANI line reduces station capacity by one. ANI (DID or Tie) lines do not reduce the station capacity in DK424 systems, Release 4.0.

Refer to the sections on ANI, Caller ID, DNIS or DID and Table 29 for more specific routing information.

Table 29 ANI, Caller ID, and DNIS Routing Destinations

Routing Destination	ANI Line ^{1, 2} Calls	Caller ID Line Calls	DNIS Line ^{1, 2} Calls	Tie & DID ^{1, 2} Line Calls	Ground ² Loop Start Line Calls
Individual Primary/Secondary/Phantom DNIs	X	X	X	X	X
CO line or pooled line buttons		X			X
Individual Distributed Hunt (DH) Groups ²	X	X	X	X	X
Individual ACD Groups	X	X	X	X	X
Remote Maintenance/Administration modem	X	X	X	X	X
System External Page (Tie lines, private network lines only)				X	
System night bell or night ringing over external Page	X	X	X	X	X
Intercept destination (station console announcement) applies to DID line types only	X		X	X	
External telephone network numbers	X	X	X	X	X
Voice mail box/Auto Attendant device	X	X	X	X	X

1. DNIS calls can be received independently or simultaneously with ANI “calling number” digits. ANI-only calls (without DNIS) can also be routed to one destination shown in this table.

2. Not supported by DK14.

Automatic Release from Hold

If an outside caller on hold hangs up, the system will automatically disconnect the call and free the line for other calls. This feature applies to DISA, DNIS and/or ANI external routed calls, AA, voice mail calls, and regular voice calls.

Automatic Release is available on a line-by-line basis and operates only with COs that provide a disconnect (Calling Party Control) signal.

Background Music (BGM)

BGM can be sent to telephone and external speakers. The customer-supplied BGM source(s) can be applied in a flexible manner.

One music source can feed both types of speakers, or both types can have their own separate source. The source used for MOH can also be piped to telephone speakers for BGM or an alternate BGM source can be connected so callers on-hold have a separate music/announcement source. The BGM source connects to the RCA jack in the system's Base Cabinet, RCTU, or to a designated standard or electronic telephone circuit port.

Caller ID

This feature enables the telephone number or name of the calling party to display on the ringing telephone's LCD. It can also be sent to an application computer or to voice mail. Up to 10 digits or 16 characters can be displayed or sent to a computer.

Caller ID (CLID) information displays on direct, incoming, transferred, and Call Forwarded calls. For PCs, CLID allows both the caller's name and number to be sent. If the Strata DK system is programmed to receive both ANI and DNIS information on incoming calls, the station user can press **Page** while the call is ringing to alternate between DNIS and ANI/Caller ID LCD displays. See [Computer Telephony Integration \(CTI\) on Page 66](#) for more information.

Caller ID is similar to ANI except that Caller ID is offered by local carriers on ground or loop start lines. Most local carriers charge an extra fee for this service.

A Caller ID Interface PCB is required, in conjunction with the normal ground or loop start CO line PCBs, to provide the Caller ID feature.

Caller ID can be provided only on analog loop start lines (with QCDU2, KCDU2, TCOU, RCOU or RCOU/RCOS) and analog ground start lines (RGLU2). It is not available on any other type of analog lines (TDDU, RDDU and/or REMU) or any type of T1 or ISDN digital lines (see [Table 29](#)).

- ♦ **DK14** – the WSIU PCB is required to provide an RS-232 interface to a customer-provided Caller ID interface device (TC-1041). CO lines that receive Caller ID must be cross-connected to the TC-1041 (MLX-41) Caller ID interface box. The TC-1041 (MLX-41) is available from TEL-CONTROL, Inc., P.O. Box 4087, Huntsville, AL 35815-4087. Phone (205) 881-4000.
- ♦ **DK40i** –the TCIU2, RCIU2 and RCIS PCBs come with four Caller ID circuits each. The TCIU2 is used for Base Cabinet lines and the RCIU2/RCIS is used for Expansion Cabinet lines to provide up to eight Caller ID interface circuits. A KCDU2 can also support Caller ID with an RCIU2. A TCIU2/RCIU2/RCIS circuit must be available for each line that is to receive Caller ID.
- ♦ **DK424** – when ordered from the factory, the RCIU2 PCB comes with four Caller ID circuits; however, an RCIS piggy-back PCB can be installed on the RCIU2 to provide four more Caller ID circuits, for a maximum of eight Caller ID circuits per cabinet slot. An RCIU2/RCIS circuit must be available for each line that is to receive Caller ID.

ANI is delivered by long distance providers on DID or Tie lines.

Centrex/PBX Compatible

All system features are compatible with Centrex/PBX operation, including repeat of Centrex/PBX ringing cadence, one-button access to Centrex/PBX features, a two- to four-digit station numbering plan, and Delayed Ringing to selected stations.

Centrex Ringing Repeat

The system can mimic CO/Centrex/PBX ringing cadences received from outside lines when it rings a called station.

Computer Telephony Integration (CTI)

CTI combines the capabilities of the Strata DK digital business telephone system with custom functionality provided by computer applications. This can be provided through the Digital Telephone Integrated PC Interface.

Digital Telephone Integrated PC Interface

A Toshiba 2000-series digital telephone can be connected to a PC. This can be used for both routine data switching simultaneous voice and data applications, and for more robust CTI applications.

The connection is made with an RS-232 cable from a communication port on a PC to an RS-232 port on the digital telephone. The RS-232 port is provided by equipping the digital telephone with an integrated PC Interface Unit (RPCI-DI). This optional unit replaces the normal telephone base and equips the telephone for simultaneous computer-telephone interface and voice/data features.

Data switching applications enable users to make data calls to printers, PCs, and other data devices. Users can also make voice calls using PC directory dialing software, without the need for a modem or an additional outgoing line.

The system can be programmed with one to four security groups, and can restrict calls between groups. It can also support modem pooling and printer sharing.

For CTI applications, digital telephones interface to a PC that runs the application software using the Microsoft Telephone Application Programming Interface (TAPI), to provide customized functionality. The PC must run Microsoft Windows software.

Any TAPI-enabled PC software is compatible with Strata DK systems. The most common types of application are database look-up and pop-up screens that provide information on the calling party. From a Strata DK system, Caller ID, ANI, DNIS and call processing information can be passed from the digital telephone to the application computer.

StrataLink

The Strata DK can interface with computer applications that conform to Microsoft Windows TAPI format. The Toshiba StrataLink Telephony Service Provider Interface (TSPI) software enables the Strata DK to communicate with TAPI applications. StrataLink TSPI software is bundled with the RPCI-DI in the form of a 3-1/2" IBM-compatible disk.

StrataLink software greatly enhances the use of the basic TAPI interface, enabling you to customize the call-control functions of your PC application, including:

- ♦ **Select how the PC application responds to the next call event** – StrataLink can accept call events from the telephone, apply call handling rules and conditions, and invoke actions in a PC application.
- ♦ **Handle multiple telephone calls** – Most TAPI compatible applications can only handle one call at a time because they only respond to a ringing line for Caller ID database lookup and screen display. StrataLink enables the application to respond to multiple calls and events that capture Caller ID and generate screen displays. It also displays transferred calls and reconnections to held calls. The display can be delayed until after the current call or for a programmed amount of time.
- ♦ **Handle multiple PC applications from the same telephone** – Incoming calls can activate actions in different applications, depending upon the type of call.

For example, you can generate “customer database” application screens of callers on your regular directory numbers, use “help desk” application software generated from ACD calls, and have your pager beep with Caller ID when you are away from your desk. Different applications can be assigned to work on specific buttons on your telephone, or on all buttons.

- ♦ **Enhance outbound calling** – StrataLink provides for outbound telephone calling and call control from the PC application.
- ♦ **Easy setup, testing, and monitoring** – StrataLink provides tools for testing the interface, debugging or monitoring the call events, and makes application setup easier. When you select from pre-defined tested applications, the proper interface is automatically assigned.

Conferencing

A variety of Conferencing combinations are available to all station users, as listed below. Stations and lines can be added in any order. (See “[Amplified Conference Interface](#)” on [Page 62](#) for more information.)

- ♦ One or two stations and two outside lines
- ♦ Two or three stations and one outside line
- ♦ Four stations on one internal [DN] line

Credit Card Calling

Callers can make credit card calls (0 + telephone number + credit card number) that bypass Toll Restriction. The calls are billed to the credit card, not to the Strata DK line. The system requires that a specific quantity of digits be dialed; otherwise, the call will be dropped within 20 seconds to prevent operator-placed calls that would be billed to the Strata DK line.

Data Switching

Strata DK offers a sophisticated optional data switching capability using PDIU-DS and RPCI-DI that can interconnect a wide range of customer-supplied data equipment, including PCs, printers, and modems. Asynchronous data can be transmitted between devices connected to PDIU-DS/RPCI-DI at speeds up to 19.2 kbps (see [Table 34 on Page 89](#)).

The system provides four data security groups to restrict data calls between groups. Dialing by PC (both data and voice calls) as well as modem pooling and printer sharing is supported.

Day/Night Modes

The system has three available ringing modes for routing incoming line calls. The routing destinations are [DNs], ACD groups, Distributed Hunt groups, Auto Attendant, DISA, and a night bell. The ringing modes are Day, Day2, and Night.

Each mode can be assigned a distinct ringing destination. The system can be programmed with either two modes (Day, Night) or three modes (Day, Day 2, Night), which can be changed by any station programmed with a **Night Transfer** button. A supervisor’s **Night Lock** button can be provided to prevent false changes in modes. Day/Night call routing applies to all incoming line types: ANI, DNIS, Caller ID, DISA, Tie, and DID lines.

Delayed Ringing

If an incoming CO, DID or Tie line or internal [DN] call rings a station [DN] and is unanswered, alternate stations can be programmed to ring 12 or 24 seconds later. The stations that were ringing initially will continue to ring after the Delayed Ringing begins. This feature is assigned on a line-by-line and [DN] basis.

It is also possible to direct loop or ground start CO line calls to the Strata DK built-in AA on a delayed ring basis. In this case, the telephone(s) that initially ring will stop ringing when the AA answers.

Dialed Number Identification Service (DNIS) (DK40i and DK424 only)

This feature enables incoming DNIS (called party) telephone numbers to display on the LCDs of ringing telephones. DNIS is provided on analog, and/or digital (T1, ISDN PRI/BRI), DID and Tie lines. An optional DTMF tone receiver PCB is required for DNIS.

Normally, DNIS is associated with “1-800” type calls offered by various long distance carriers; however, the Strata DK can provide DNIS information over DID and Tie line circuits.

Traditionally, each 800-number is assigned to its own line group, often resulting in a large number of under-used lines. DNIS allows multiple numbers to ring into the same line or line group, which provides a more efficient use of 800-numbers. Each DNIS line is used on an as-needed basis for different 800-number calls.

- ♦ **DK14** does not support DNIS.
- ♦ **DK40i** supports up to 200 DNIS numbers and a maximum of 100 telephone network numbers. The K5RCU (DK40i) optional tone receiver PCB is required for DNIS. Each DNIS, DID or Tie line reduces the station capacity by one.
- ♦ **DK424** supports up to 500 DNIS numbers and a maximum of 300 telephone network numbers. RRCS optional tone receiver PCB is required for DNIS. See “[Station and Peripherals Capacities](#)” on [Page 89](#). DNIS, DID or Tie lines do *not* reduce station capacity in DK424 Systems, Release 4.0.

The DNIS numbers are correlated in the system database with assigned DNIS names. DNIS names (up to 16 alphanumeric characters) display on direct incoming, transferred, and Call Forward calls. This allows incoming calls to be identified and answered appropriately.

DNIS numbers can be assigned to ring unique destinations in the Day, Day2, and Night Ring modes (see [Table 29](#)). The DNIS (called number) digits can be received independently or simultaneously with ANI “calling number” digits (see “[Automatic Number Identification \(ANI\)](#)” on [Page 63](#)).

Priority of ANI or DNIS is set for each line in system programming. DNIS digits can also be sent to a PC. See “[Computer Telephony Integration \(CTI\)](#)” on [Page 66](#).

External Telephone Network Numbers

All DNIS/DID/Tie numbers that ring into the Strata DK can be routed externally to any outside telephone number. Depending on the application, the caller DNIS name may be passed to the destination Strata DK when routed over the telephone network.

Voice Mail

If assigned in the system database, incoming calls for each unique DNIS/DID/Tie number can be directly routed or Call Forwarded to a designated voice mailbox. This allows callers of each DNIS/DID/Tie number to receive immediate personal custom greetings.

Note This feature is available on in-band integration only. It is not available using SMDI.

Direct Inward Dialing (DID) Lines (DK40i and DK424 only)

Based on the final digits of a dialed telephone number, DID enables incoming calls over a single line to directly ring one or a number of stations which share a common [DN]. DID numbers can be assigned to ring a number of destinations (see [Table 29](#)). DK14 does not support DID.

DID is provided by analog or digital (T1, ISDN PRI/BRI) lines. The TDDU and RDDU analog PCBs support DID. For the DK424 only, the digital T1/DS-1 (RDTU2) or ISDN PRI (RPTU) PCBs support DID.

Each DID number can be assigned a Name to display on an LCD telephone that rings when the DID number is called. Each DID line has a single office code and a block of extension numbers (the final digits) that can be individually assigned in system programming to ring stations.

DID lines can directly access the remote maintenance modem and can optionally provide automatic Camp-on-busy when callers dial a busy [DN] on incoming DID calls. This feature provides a camp-on tone and distinctive LED flash at the busy station.

- ✦ **DK40i** – each DID line reduces the station capacity by one.
- ✦ **DK424, Release 4.0** – DID lines do not reduce station capacity.

An optional tone receiver PCB (K5RCU or RRCS) is required for DID line DTMF operation.

Direct Inward System Access (DISA)

Outside callers using a DTMF-capable telephone can dial internal stations or outgoing lines directly, without going through a receptionist or operator. DISA security codes and/or a verified account codes, each up to 15 digits, can be assigned to prevent undesired access to lines.

DISA is available to any quantity of ground or loop start lines (not Tie or DID), either directly or through the Strata DK built-in AA. It enables privileged users to take advantage of the benefits of the Strata DK even when they are not on the premises. An optional tone receiver PCB (QRCU3, K5RCU or RRCS) is required for DISA.

DISA can be accessed by calling into the DK built-in AA. To prevent users from calling into the Auto Attendant and accessing an outgoing line with DISA to make unauthorized external calls, be sure to use the DISA security code.

Distinctive CO Line/Directory Number Ringing

The incoming line ringing tone to digital telephones is distinct from the internal ringing tone indicating the type of the call. This feature is optional for standard telephones by using a different ring pattern.

Door Lock Control

Digital and electronic telephone station users can unlock a customer-supplied electronic door lock at the touch of an optional button on their telephone.

- ✦ **DK14** supports up to two locks
- ✦ **DK40i** supports up to three locks
- ✦ **DK424 RCTUA** supports up to four locks; all other processors support up to five locks

Door Phones (MDFB)

Door phones are frequently mounted near building entrances and associated with a customer-provided door lock to help screen visitors. Door phones can be assigned to ring [PDNs] and/or [PhDNs]. Each door phone must be connected to a DDCB or HDCB.

They also monitor sound—station users can call the door phone and listen to sounds from the surrounding area. In a warehouse-type environment, a door phone can work as a “hot link,” for example, the door phone can have a preassigned button that accesses a certain telephone [DN] in an office, and any common [DNs].

- ✦ **DK14** supports up to 6 door phones
- ✦ **DK40i** supports up to 9 door phones
- ✦ **DK424** supports up to 12 door phones

DTMF Back Tone

The system can be programmed to allow or prevent DTMF tones from being returned to digital telephones when a user dials on outside lines or sends DTMF digits to a voice mail device.

DTMF and Dial Pulse CO Line Compatible

The Strata DK System works with either DTMF or rotary dial pulse CO lines on a line-by-line basis.

DTMF Signal Time (80/160 milliseconds)

DTMF tones that are sent via Speed Dial to lines and via automatic dialing to voice mail devices can be set to 80 or 160 milliseconds. The time can be set independently for line out-dialing and for voice mail automatic dialing. See [“Continuous Dual-tone Multi-frequency \(DTMF\) Tone”](#) on [Page 94](#).

Emergency Ringdown

Standard telephones can be programmed to automatically ring a designated extension when they are taken off hook, after a predetermined time without dialing. The receiving digital or electronic LCD station or attendant console displays the station name/number of the off-hook calling station. This feature does not work with digital and electronic telephones.

In healthcare applications, this feature is known as Emergency Ringdown operation. It is used to assist callers who may not be able to complete a call by dialing. If a station is left off-hook, continuous ringing will occur at a designated extension. This feature is also known as “Hotline Service” for hotel/motel applications. See [“Hotline Service”](#) on [Page 72](#) for more information.

Enhanced 911 (E911) Service

In the public safety arena, Enhanced 911 (E911) is distinguished from Regular 911 by the delivery of specific location information to the console of the dispatcher handling the emergency call. The public switched telephone network (PSTN) delivers a Caller Emergency Service Identifier (CESID) to the Public Safety Answering Position (PSAP) as part of the telephone call set up. PSAP procedures outside the telephone connection translate the CESID into a specific location to which emergency services can be dispatched. The Strata DK is not involved in the translation of CESID into Automatic Location Information (ALI).

The Strata DK40, DK40i and DK424 can accept a call dialed as “911” or “9” + “911” from any extension and deliver it to a specially programmed, single-line telephone port that connects to customer-provided, emergency call adjunct equipment. As part of the call, the DK communicates the originating directory number (DN) to the external equipment using DTMF signaling. The external equipment translates the received DN to a valid CESID, connects the call to the PSTN and delivers the CESID information when the call is answered.

Centralized Automatic Message Accounting (CAMA) trunks connect the customer-provided equipment to the PSTN. When its CAMA trunk interfaces become available, the Strata DK424 will be able to connect directly to CAMA trunks, eliminating the need for external equipment. The RMCU PCB with one RCMS subassembly provides two CAMA trunk interfaces in one cabinet slot. One more RMCS may be added to the RMCU for a system total of 4 CAMA trunks.

An extension dialing “911” or “9” + “911” will be routed to its appropriate CAMA trunk. The DK424 will seize the CAMA trunk, dial “911,” and deliver that station's CESID once the trunk is answered. The DK424 stores a unique, programmable CESID for each Primary Directory Number.

The DK424 has several internal notification features. It will notify all consoles and designated stations of an E911 call. It may be programmed to initiate a conference call including the

originating telephone, the PSAP and an internal emergency station. The SMDR port will generate a special record at the beginning of the call as well as at the end.

DK owners are urged to learn local regulations and availability of services which may vary widely. A growing number of locations require a business owner to maintain accurate location information in a public safety database. Certain locations require E911 only for systems functioning as PBXs or hybrids but not as key systems. Contact your local emergency services provider and Local Exchange Carrier for specific information. Another useful resource is the National Emergency Number Association (NENA) at www.NENA.org.

External Page Zones

The Strata DK40i can support up to four External Page Zones and DK424 can support up to eight (Tables 24 and 25). Station users can access one, four or eight zones simultaneously by dialing a brief access code. The zones are composed of customer-supplied speaker(s) and amplifier(s) which interface with one or two PIOU PCBs. DK14 does not support zone paging.

Flexible Button Assignment

Each of the flexible buttons on digital and electronic telephones can be assigned for feature or CO line access, enabling station users access to features and lines with the touch of a button. Digital telephones are available in 10- and 20-button models.

Flexible Directory Numbers

A “flexible” number of digits can be programmed for station [DNs] in the Strata DK. The DK14, DK40i and DK424 station [DNs] can have from one to four digits. The maximum available number of unique station [DNs] ([PDNs] plus [PhDNs]) are listed below:

- ♦ **DK14** – up to 20 unique station [DNs] are allowed
- ♦ **DK40i** – up to 56 unique station [DNs] are allowed
- ♦ **DK424** – up to 672 unique station [DNs] are allowed

Single-digit [DNs], such as “0”, can be assigned to attendant consoles or attendant telephones.

Flexible Line Ringing Assignment

Each CO line can be programmed to ring the Auto Attendant, night bell, DISA, remote maintenance modem or any station [DN] in the system. A different ringing assignment can be created for each of three ringing modes—Day, Day2 or Night. Stations assigned to ring can do so with any of the following three timing designations:

- ♦ **Immediate** – Stations assigned Immediate timing ring as soon as the line rings into the system.
- ♦ **Delay 1** – If stations with Immediate timing have not answered within 12 seconds (3 rings), stations assigned Delay 1 timing also begin ringing. Immediate Ring telephones continue to ring when Delay 1 Ring telephones ring.
- ♦ **Delay 2** – If the above stations have not answered within 24 seconds (6 rings), stations assigned Delay 2 timing also begin ringing. Immediate and Delay 1 Ring telephones continue to ring when Delay 2 Ring telephones ring.

Group Paging

Digital and electronic stations can be divided into Paging Groups. Any station user can make a page announcement to just one or all of these groups. The page is sent to the speakers of all idle telephones in a page group. For more information, see [Table 34 on Page 89](#).

- ♦ **DK14** and **DK40i** each support up to five Paging Groups, including the All Call Page Group.
- ♦ **DK424** supports up to nine Paging Groups in systems operating with the RCTUC/D and RCTUE/F common control units (up to five are supported with either the RCTUA or RCTUBA/BB). These groups include the All Call Page Group.

Note Cordless DKT-2004-CTs and standard telephones are not compatible with Paging.

Handsfree Directory Number Paths

All stations can have handsfree conversations simultaneously. Because [DN] paths are nonblocking, the number of conversations is only limited by the amount of digital and electronic stations.

Hospitality Management Information System (HMIS)

The Toshiba Strata DK Hospitality Management Information System (HMIS) is a PC-based solution, designed to meet the specific operational needs of small- to medium-sized hotels and motels.

The HMIS tightly integrates with the Strata DK40i and DK424 Digital Telephone System, Release 3.1 or higher, and the Stratagy Voice Processing System, providing a complete and fully-integrated hospitality package.

The HMIS is an optional turnkey package that includes both the PC and software. The packaged product includes a PC with a Pentium® 133 MHz processor, 2GB hard drive, three serial ports, keyboard, mouse, SVGA color monitor, and software (printer not included). The HMIS software is a Microsoft Windows 95-based application.

The HMIS PC is dedicated to running the HMIS server program and functions as a front desk terminal. In applications requiring multiple front desk terminals, PC HMIS workstations can be networked together to share a common database.

The HMIS application provides hotel/motel features and property management capabilities that are not resident within the Strata DK telephone system. The HMIS is well integrated with the telephony features of the Strata DK telephone system to which it is attached.

The Strata HMIS provides guest check-in/check-out, up to 20-year reservation capacity, automatic wake-up calls, SMDR telephone call tracking and costing, billing, telephone system control, and many other features. See the *Hospitality Management Information System General Description* for details.

Hotline Service

Standard telephones can be automatically ring a designated extension if they go off hook and do not dial with a preprogrammed time. The receiving digital or electronic LCD station or attendant console displays the station name/number of the off-hook calling station. This feature does not work with digital and electronic telephones.

Hotline Service is very useful for hotel/motel applications, where it may be preferable to have lobby or public area telephones without dialing capability. Standard telephones can be programmed to automatically call a specific number, such as the front desk. This feature is also known as Emergency Ringdown in the healthcare field (see “[Emergency Ringdown](#)” on [Page 70](#).)

Integrated Services Digital Network (ISDN)

ISDN is a set of integrated telecommunications services, available over the public telecommunications networks. ISDN makes it possible to send, receive and modify information using telephone lines in ways that were not previously possible, such as:

- ♦ Dynamic use of individual or groups of standard (POTS), DID, Tie, FX, WATS, 800 lines on an as-needed basis
- ♦ Much faster call setup and data transfer up to 128 kbps
- ♦ Multi-purpose line use, including sharing lines for voice, data, fax, and video
- ♦ DID functionality based on the number dialed; without needing to reserve a block of numbers

ISDN service comes in two forms:

- ♦ **Primary Rate Interface (PRI)** supports 23 or 24 simultaneous voice or data connections. PRI is similar to digital T-1 service and uses two pairs of wires from your phone company.
- ♦ **Basic Rate Interface (BRI)** supports up to two simultaneous connections using a single pair of wires.

National ISDN standards were first established in 1992. These were formed for all equipment providers and services to create a common set of functions for these new services. The public network is in the process of implementing nationwide the National ISDN 2 (NI-2) services and some locations have started National ISDN 3. Strata DK Release 4.0 is based on NI-2.

ISDN Primary Rate Interface (PRI)

PRI is the larger ISDN interface (via the RPTU) and uses the 23B+D transmission format, which has 23 64-kbps bearer channels and one 64-kbps data (control) channel, with total bandwidth of 1.544 mbps.

PRI is designed as the trunk interface to the ISDN network. PRI connects the Strata DK424 telephone system to an intra- or inter-LATA communication provider. PRI can be used to send/receive voice and/or data.

More importantly, PRI can save money by enabling the multiple use of the channels on the PRI link for a variety of services, such as DID, Tie, FX, WATS, 800, etc., on demand.

This capability to support multiple services and dynamically allocate channel use as needed is known as the call-by-call feature. PRI lines also support Calling Number Identification Services (CNIS).

A dealer-supplied, UL listed, Channel Service Unit (CSU) is required between the DK PRI interface and the PRI line provider interface in most locations of the U.S. In Canada, a CSA certified DSU/CSU must be installed.

ISDN Basic Rate Interface (BRI)

Note Strata DK40i and DK424 support BRI S/T. The DK424 and DK40i will support BRI U basic features in Release 4.2. No supplementary features are offered in these releases.

BRI is the smaller ISDN interface and provides two simultaneous voice or data connections with a single interface. BRI uses the 2B+D transmission format which is defined as two 64-kbps bearer channels and one 16 kbps data (control) channel. The D-channel carries call setup control data.

ISDN BRI station applications allow the connection of ISDN instruments, such as a group IV fax, PC, computer terminal or port, a LAN bridge, video conferencing terminal, Internet access devices, LAN access routers, or other devices that benefit from an all digital transmission link.

BRI applications for the DK424 will include video conferencing, remote access servers, faster Internet access, point-of-sale devices and high-speed data connections from ISDN stations to the public ISDN network, as well as typical voice and fax connections. With the correct external adapter, data can be sent up to 128 kbps.

Like PRI, BRI provides CNIS, DID, Direct Inward Lines, and other data access services when used to access the public network.

The Strata DK424 BRI cards will support both station side and trunk side connections. The Strata DK424 system will also support BRI interface from the public network as a CO line service. There are two types of ISDN BRI interfaces: S/T type (via RBSU/RBSS) and the U-type (via RBUU/RBUS). Both types are used in the U.S.

The Public Switched Telephone Network provides BRI U-type lines only; therefore, a dealer-supplied, external Network Terminal Unit (NT-1) is required to connect DK S/T-type BRI line circuits to the network. The NT-1 must be UL listed (U.S.) or CSA certified (Canada).

Call-by-Call Service Selection

This feature permits the grouping of individual PRI B-channels to be shared among various types of services specified by the customer, instead of having to dedicate each channel to a particular type of service. Using this common pool of channels provides much improved traffic handling than using dedicated channels.

This dynamic allocation of service can reduce the number of circuits required to access various services, especially if various services have different peak busy periods.

In Release 4.15, the DK424 will enable specifying the minimum and maximum number of B-channels used for each service on a common set of B-channels in system programming. Minimum and maximum values can be set for three time periods during the day.

These values can be used to ensure that a minimum number of channels remain available for incoming calls. They can also be used to determine if calls should be rejected because they exceed the maximum number subscribed for that service. Until Release 4.15 becomes available, Call-by-Call minimum/maximum service will be implemented at the CO.

Call-by-Call services can be specified to map Strata DK capabilities to network services such as DID, Tie, FX, WATS, 800, etc. These services can be provided via the local telephone carrier or be connected to any ISDN inter-exchange carrier.

Outgoing calls, specific numbers, or DID numbers can be checked against the Call-by-Call table which lists all valid DNs. DNs can be identified on a per station basis to enable billing calls to a selected service or station. All numbers used for identifying the call must be subscribed from the providing service, otherwise the call will be rejected by the provider.

Non-Facility Associated Signaling (NFAS)

NFAS provides the ability to create ISDN trunk groups beyond the 23 channels available with a single PRI. This is extremely important when Call-by-Call Services are used since all B-channels must be controlled using a common D-channel.

The Strata DK system will support one additional PRI (two circuits to be linked with one D-channel). This extends the number of call-by-call B-channels to 47 (2 x 24 minus 1). This provides better performance and cost savings in high volume ISDN PRI applications.

Calling Number Identification Services (CNIS)

CNIS features provide “Calling Party Information” to the network (outgoing calls) and from the network (incoming calls). There are four types of CNIS services:

- ♦ **Number Provisioning** for outgoing calls is controlled by subscription parameters with your telco provider. The choice is for the number to be necessary or not. The number sent is based on the call originator and the call type. The originator can be a tandem call, a station (with or without DID), or a station with a designated number. The type of call refers to whether it is a direct or redirected (call forwarded) call.

For a tandem call, the Calling Party Number digits received are the digits that will be sent. For a direct station call, the default number assigned to the selected service, and which is programmed into the Strata DK as the Listed Directory Number (LDN), will be the number sent. In this case, the system can send a fixed number (assigned in the system) or it can use the DID programming to determine the number to be sent.

- ♦ **Number Screening** is normally performed by the public network to ensure that the call being placed has a valid billing number. In systems with a flexible Calling Number Provisioning, the network can determine if the call is for a valid billing number. Based on this, it can either place or reject the call, rather than completing the call and billing it to the default LDN.
- ♦ **Number Privacy** allows the caller to prevent the public network from delivering the Calling Number to the called party on a per-call basis. Service subscribers can request that the number be presented or not, as a default from the public network. Subscribers can also change default settings. If a public telco service allows changes to be made, then a user can enter change a code to the setting for that call after selecting a trunk group.
- ♦ **Number Delivery** sends the calling number with the call setup message, if that number is not blocked. The Strata DK handles the number the same way that ANI information from T1 trunks is handled. For instance, the number can display on the called telephone’s LCD, or it can be used by TAPI interfaces, or it can be recorded in SMDR data records.

Note Name Delivery will not be supported in this release, due to the lack of a common specification for the public ISDN network.

Least Cost Routing (LCR)

Different route plans may be designed to automatically place outgoing calls over the most cost-efficient routes. See the table below for LCR capacities.

Three different LCR time schedules with their own priority schedules can be set up for the business day. Stations can be grouped into one of eight LCR classes, each with its own routing priority. Selected station users may have priority use of a line, even when the route with the lowest cost is not available. LCR is compatible with ABR.

Table 30 Least Cost Routing Capacities

Least Cost Routing	DK14	DK40i	DK424			
			RCTUA	RCTUBA/BB	RCTUC/D	RCTUE/F
LCR route plans	8	8	8	8	16	16
Area Code/Office Code exception tables	8	8	8	8	16	16
Time schedules	3	3	3	3	3	3
Station classes	4	4	4	4	8	8
Route definition tables	4	4	4	4	6	6
Modify digit tables	6	6	6	6	12	12

Line Groups

For easy access, various types of outside lines can be assigned to groups (normally for pooled line and LCR applications). For example, all local lines can be assigned to one group and WATS lines in another group. Station users access line groups by dialing an access code or by pressing a feature button.

- ♦ **DK14** provides up to 4 line groups
- ♦ **DK40i** provides up to 8 line groups
- ♦ **DK424** provides up to 16 line groups

Line Queuing

A station user can use the Automatic Callback feature to enter the queue for a busy outgoing line. When the line becomes available, the system calls the station back. Queuing applies to single lines, line groups, and when calling via LCR.

Live System Programming

Programming the Strata DK from an on-site or off-site location does not interrupt the operation of the system in most cases. It is interrupted for hardware upgrades.

Memory Protection

If the power fails, the Strata DK has an internal battery backup that protects data and the customer's programmed configuration. This information will be maintained within a powerless system for at least six years.

Message Waiting

Any station and most voice mail devices can leave a message waiting indication (light) on a designated message waiting light of a digital, electronic, or standard telephone station.

Message waiting lights can be activated when a voice mail message has been left, or they can be turned on by a calling station. The station user can retrieve messages by pressing the button next to the message waiting light.

- ♦ **DK14 and DK40i** – QSTU2 and KSTU2 PCBs do not support standard telephone MW lamps.
- ♦ **DK424 and DK40i** – an RSTU2 PCB must be connected to a standard telephone with a MW lamp to enable this feature. The DK40i and DK424 provide Message Waiting to standard telephones with a message waiting lamp. The user can enter an access code to retrieve the messages. A standard station can store up to four indications.

Multiple Directory Numbers

A [DN], sometimes called an “extension number,” is the number someone must call to reach a destination within the system. To maximize call coverage flexibility, station [DNs] can appear on multiple telephones. Also, individual telephones can have multiple [DNs] (see [Figure 17](#)).

The system provides three types of [DNs]: Primary, Secondary and Phantom. All [DNs] can be used to originate and answer calls. If you press a [DN] while on a call, it releases the existing call and provides dial tone to make another call.

- ♦ **DK14** supports a maximum of 10 [PDNs] and 10 [PhDNs]
- ♦ **DK40i** supports a maximum of 28 [PDNs] and 28 [PhDNs]
- ♦ **DK424** supports a maximum of 336 [PDNs] and 336 [PhDNs] (see [Table 32](#) for maximum capacities for various common control units)

Primary Directory Number [PDN]

Each station in the Strata DK has a unique [PDN]. This [PDN] can appear on multiple buttons (up to four) of the primary station.

Secondary Directory Number [SDN]

When the [PDN] of a station appears on another station, it becomes an [SDN]. Any [PDN] can appear as an [SDN] on all other Toshiba telephones in the system. A [PDN]/[SDN] can ring on up to 120 telephones in the system. Each telephone can be assigned up to four of the same [SDN]. The maximum number of [PDNs] plus [SDNs] on each telephone is 16.

Phantom Directory Number [PhDN]

This is an additional [DN] that can be dedicated to a station or to a group of stations (usually in the same area or department). Each unique [PhDN] can only appear once on a given telephone, but each telephone can be assigned up to eight different [PhDNs].

Any [PhDN] can appear on all Toshiba telephones in the system. A [PhDN] can ring on up to 120 telephones in the system. Each [PhDN] must be assigned to a designated telephone owner via system programming.

Each [PhDN] is flexibly assigned to an owner telephone in system programming. Only [PhDN] owner telephones have the following privileges:

- ◆ Set Call Forward for [PhDNs]
- ◆ Set Call Forward Mailbox destination for [PhDNs]
- ◆ Receive Message Waiting (MW) indication for up to four [PhDNs] on individual Phantom Message Waiting [PhDN/MW] LEDs
- ◆ Receive OCA when the [PhDN] is called

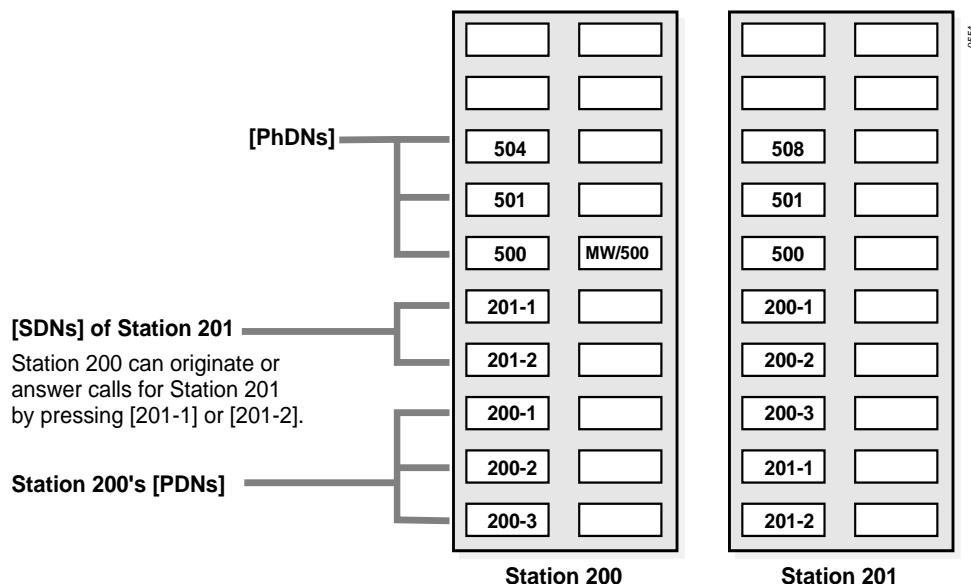

Figure 17 Multiple Directory Number Example

Notes

- Incoming calls come in to a telephone's [PDNs] from the top down to prevent "call collisions." For example, incoming calls to Stations 200's [PDN] will first ring the top "200-1" line, a second call will ring "200-2" below it, and a third call will ring "200-3." Auto preference to

- select a [DN] to make a call by going off-hook is from the bottom [PDN] up. This avoids answering an incoming call while attempting to originate a call.
- Each [PhDN] can have a dedicated Message Waiting [PhDN/MW] LED/button to notify the [PhDN] owner telephone user that there is a message for the person or department associated with the [PhDN]. Up to four [PhDNs/MWs] can be programmed onto the flexible buttons of each telephone. In the above example, [MW/500] is the Message Waiting button for [PhDN 500].
 - A station [PDN] shows busy on Busy Lamp Field when the station is in DND mode or off-hook on any [DN], CO line or Tie line. [PhDNs] do not display Busy Lamp indication.
 - [PhDNs] are usually associated with a function such as an “800” number for a Technical Support Group; whereas a specific [PDN] is usually associated with a person, for example, Station 200 is assigned to Steve, Station 201 is for Susan, etc.

Multiple FCC Registration

The DK14 and DK40i can be configured as either a key or hybrid system with separate FCC registration numbers for each type. The DK424 can be configured as either a key, hybrid, or PBX system with separate FCC registration numbers for each type.

Multiple registration ensures compliance with FCC regulations, regardless of how the system is configured. The appropriate configuration for an individual system depends on its function.

Systems configured only for manual selection of lines via line buttons may be registered as key systems; systems with Automatic Line Selection, LCR, **Pooled Line** buttons, etc., usually must be registered as hybrid or PBX systems.

Music-on-hold (MOH)

A customer-supplied radio, tape player, tuner, compact disc player, or other device can be used to send music or announcements to parties on-hold on CO lines or on [DNs].

Night Ringing Over External Page

Incoming line or door phone calls can be programmed to ring over an external speaker when the system is in the Night mode. The call can be picked up from any telephone. After-hours employees who are not near a ringing telephone can easily answer calls with this feature.

Night Ringing Over Selected Page Zones

Lines can be programmed to night ring over four selected PIOUS Page zones via customer-supplied paging equipment. Programmed lines can be divided into tenant groups which can then be assigned to night ring over the selected zones:

- ♦ **DK40i** supports two tenant groups
- ♦ **DK424** supports two tenant groups with RCTUA; all other processors support four tenant groups

Non-blocking Talk Paths

All outside lines and internal [DN] lines can be used at the same time.

Off-premises Station

Off-site standard telephones can be part of the system, having access to many of the features offered by the Strata DK. Each off-site station requires a special line from the CO.

Outgoing Call Restriction

Stations can be selectively restricted from originating calls over any number of lines. The same stations can receive incoming calls on those restricted lines.

Pooled CO Line Button

Several lines can be pooled to appear under one digital telephone, electronic telephone CO **Line** button. The lines are usually pooled in categories, e.g., WATS lines in one pool, regular lines in another, etc. Pooled and single-appearing line buttons are designed for use with loop and ground start lines, not DID, Tie, DNIS, or ANI lines.

Power Failure Transfer

CO line(s) can be switched directly to dedicated standard telephones (customer-provided 2500- or 500-type) for incoming and outgoing calls in the case of a system power failure. The number of PF telephones available depends on system configuration. Refer to the appropriate configuration chapter in the *Strata DK Installation & Maintenance Manual*.

During normal operation with AC power, in the DK14 or DK40i Base KSU, the PF telephone connected to the base KSU PF jack does not function.

In the DK424 and the DK40i Expansion Unit, PF telephones connected to DPFT/RSTU2 do function as a normal standard telephone with all the Strata DK available features, when operating with normal AC power.

During a power failure, the following connections are made:

- ✦ **DK14** – one CO line is connected directly to the PF phone.
- ✦ **DK40i** – in the Base KSU, one CO line is connected directly to the PF phone (up to eight more can be added in the Expansion Unit).
- ✦ **DK424** – in the DK424, multiple CO lines can be switched. If AC power is lost, the PF telephones are automatically/directly connected to a pre-wired CO lines.

PF transfer requires an external unit called the Power Failure Transfer Unit (DPFT) and the RSTU2 PCB on the DK424 and in the DK40i Expansion KSU (if more than one PF telephone is needed). Each DPFT provides interface for eight power failure telephones.

An RSTU2 PCB is required to supply the DPFT with a -24VDC control signal and ground connections.

Privacy/Non-privacy Calling

This feature applies to CO **Line** buttons only and does not apply to [DNs]. Outside CO **Line** buttons can be Private or Non-private on a station-by-station basis. Private lines prohibit users from pressing a common CO **Line** button and accessing a line that is already in use, whereas users can do so on Non-private lines.

Private line users can change the mode with a **Privacy Release** button, enabling as many as three stations (total) on a line. Non-private users can block access to their lines with a **Privacy** button.

Relay Service

The DK14 KSU and DK40i Base KSU provide one relay contact to provide the functions listed below. For the DK40i and DK424, the PIOU, PIOUS, and PEPUs each have two pairs of relay contacts that can each be programmed for one of the following two functions.

External Page/Door Lock Control

- ✦ **External Page** is a Page over external speakers will mute BGM that is being broadcast over the same speakers.
- ✦ **Door Lock Control Relay** requires PIOU or PIOUS relays. Only the PIOU and PIOUS relays will open a customer-supplied door lock for three or six seconds when a designated button is pressed on selected telephones.

Night Relay/Hold Relay

- ✦ **Night Relay** enables answering machine or a night bell (or chime) will be activated when a call rings in during the Night mode.
- ✦ **Hold Relay** enables an MOH source will turn on only when calls are placed on-hold.

Remote Administration/Maintenance

See [“System Program Administration Software \(DKAdmin\)”](#) on Page 83.

Reserve Power

Customer-supplied 12-volt batteries (gel-cell and maintenance free) can be connected to the system power supply as a power failure backup.

If there is a power failure, Strata DK automatically switches over to battery power without any interruption to operation. A built-in charger circuit keeps the batteries charged during normal system operation.

Reserve power duration depends on the condition of the batteries and the system load, and is specific for each Strata DK model. Reserve power batteries must be fully-charged, connected, and tested before a power failure occurs.

- ✦ **DK14** – see [“Power Supply”](#) on Page 4
- ✦ **DK40i** – see [“Power Supply”](#) on Page 13
- ✦ **DK424** – see [“Power Requirements”](#) on Page 26

Simplified Message Desk Interface (SMDI)

This feature provides system integration between the Strata DK and the Toshiba Strategy and VP voice processing systems.

SMDI is a standard (RS-232 serial) link; its protocol was developed by Bellcore and is used by many PBX and Central Office telephone systems to integrate with voice mail systems. SMDI does not support Strata DK DNIS mail box routing. SMDI interface requires that the Strata DK have a WSIU, TSIU, PIOU, PIOUS, RSSU, or RSIU PCB installed.

By using this standard integration method, a Strata DK has the flexibility to integrate with a wide range of standard voice mail machines and also to grow with the standard as more features are added for enhanced integration.

Advantages provided by the Strata DK and the Strategy/VP SMDI integration are:

Better Port Usage

SMDI is a faster and more efficient integration compared to DTMF (in-band) integration and is recommended for high-traffic installations.

Improves Call Coverage

Stratagy uses the call forwarding status (e.g., all calls, no answer, busy, etc.) supplied by SMDI to provide better call coverage. The status information also enables Stratagy to perform custom applications using Stratagy RNA and Busy Chain options.

Streamlines Messaging Procedures

- ✦ SMDI provides the calling party's extension to Stratagy. Users calling Stratagy from their telephone do not have to enter their User ID to log on to their mailbox.
- ✦ When an internal party calls an extension that is forwarded to voice mail, SMDI applies the calling party's identification to the message. Since the source of the message is already known, the message recipient does not have to enter the User ID when replying to it.
- ✦ Caller ID and ANI numbers are delivered to the Voice Mail machine via SMDI packets. DNIS names are not sent on SMDI packets.

Speed Dial

Speed Dial enables users to dial frequently-called telephone numbers (up to 20 digits per number) quickly by dialing a brief access code or by pushing a feature button. DK and Centrex/PBX feature access codes can also be stored for Speed Dial. There are two types of Speed Dial: System and Station.

System Speed Dial

System Speed Dial numbers can be used by all stations on the system. A designated station or attendant console or DKAdmin PC can assign System Speed Dial numbers.

- ✦ **DK14, DK40i** and the **DK424 RCTUA** processor provide up to 40 System Speed Dial numbers that can be used by all stations on the system.
- ✦ **DK424 RCTUBA/BB** and **RCTUC/D** provide up to 100 Speed Dial numbers.
- ✦ **DK424 RCTUE/F** can have up to 800 System Speed Dial numbers.

Station Speed Dial

The Strata DK14, DK40i, and DK424 Systems provide up to 40 personal Station Speed Dial numbers for each individual user. Each user Station Speed Dial numbers are exclusive to that user, and are not available to other station users. For more information, see [“Speed Dial Buttons”](#) on [Page 99](#).

Station Hunting

The system supports two types of station hunting:

Serial Hunt

When a called [DN] ([PDN] or [PhDN]) is busy, the call (data or voice) will hunt to an assigned [DN]. If that [DN] is busy, the call hunts to the next assigned [DN], and so on.

The call is eventually routed to the first idle station, or if it is a CO line call, then the call camps on to the last station in the hunt sequence, if all stations are busy.

If a hunt station is call forwarded, calls to the station will ring at the forwarded destination—not the hunt destination. Internal callers will receive busy tone if calling into a hunt group in which all stations are busy.

Distributed Hunt (DH)

When a call is directed to the DH group, the system hunts for and sends the call to the next available station that is assigned to the DH group. Calls are evenly distributed to the members of the group on a rotational basis. The rotation of DH calls always follows the last telephone that receives a call.

Each DH group is assigned to a unique [DN]. When a DH-[DN] is called, the call is sent to the [PDN] or **Pooled Line** button of the telephone that is next in rotation to receive calls.

If all stations in the DH group are busy, calls directed to the group will be placed into a call waiting queue and will be routed to the next available telephone in the DH group. Callers in queue will receive ringback tone until a DH group member becomes available to answer the call.

DH calls can be routed or transferred from Caller ID/DID/DNIS/ANI lines, Tie lines, DISA lines, loop/ground start CO lines, [DN] lines, and built-in and/or external AA. They can also be forwarded calls from stations, and overflow calls from ACD groups.

The DK14, DK40i, and DK424 provide a maximum of 16 DH groups. The queue can contain up to 10 calls per group. A telephone can be a member of more than one (up to 16) DH group. Up to 32 telephone [PDNs] can be programmed in any rotation order desired in each DH group. [PhDNs] can be assigned as members of the DH group in Release 3.1 and higher.

Station Message Detail Recording (SMDR)

The system produces calling information that is sent to a printer or call accounting device connected to a serial interface unit PCB (see below):

- ♦ **DK14** – WSIU
- ♦ **DK40i** – TSIU in the base KSU, PIOU, PIOUS in the Expansion Unit
- ♦ **DK424** – PIOU or PIOUS or RSIU/RSIS

The station number and the [DN] that made, received, or transferred a call is sent to the SMDR device after the call or transferred call is completed. Account Code information can also be included. ANI numbers, Caller ID numbers, and DNIS/DID/Tie numbers/names can be programmed to appear on the SMDR report. If present, the names take the place of the system Account Codes.

SMDR reports include the called number(s), and the time and duration of calls. Customers can select what type of calls—all calls, outgoing only, long distance calls—they want to appear on the report.

Station Relocation

This feature enables stations to be moved from one location to another without having to reprogram the Strata DK. Stations which are moved will maintain their set features and all [DNs], including Primary, Secondary, and Phantom. This feature does not work when stations are relocated from a PDKU to a KCDU PCB in the DK40i.

StrataControl (DK40i and DK424 only)

StrataControl™ is a system administrative tool designed specifically for end users who prefer to administer part of their own telephone system. It is a Windows-based PC application enables limited access to Strata DK40 and DK424 system programming functions.

StrataControl also enables printing telephone keystrips based upon button programming assigned within the Strata DK system. Quick reference user guides can be printed based upon station features and options assigned within the system. StrataControl also includes an on-line telephone user guide, compiled from the end user's DK database, specifically for each telephone.

System Programming through a Station

The system can be fully programmed with a 20-button, LCD-type digital or electronic telephone. Programming telephones function the same as any other station when they are not in programming mode. See “[Live System Programming](#)” on [Page 76](#).

System Program Administration Software (DKAdmin)

Toshiba DKAdmin software enables all customer configuration program options (speed dial, number plan, ring assignment, etc.) to be downloaded and stored on a PC disk. The customer data can be added or changed, using a PC independent of the Strata DK. DKAdmin is fully functional on DK14, DK40i and all processors of DK424.

The new (or original) customer program options stored on disk can be uploaded into the Strata DK from the PC to change (or restore) customer configuration.

DKAdmin software can be used to change or restore a customer’s configuration database stored on the PC disk and then installing at the customer’s site or remotely by modem. It enables customer database information to be transferred from one common control PCB to another, even when upgrading to a higher level processor.

Remote maintenance interface is enabled by the WSIU (DK14 only), TSIU (DK40i only) or for both DK40i and DK424, an RSSU and a customer-provided external modem, or a PIOUS/PIOUS with IMDU built-in-modem, or an RSIU with RMDS (DK424 only).

An external customer-supplied modem could be used in place of IMDU or RMDS; however, the external modem will require a standard telephone port or CO line.

T1 Interface (DK424 only)

The T1 (DS-1) interface provides the system with up to 24 digital voice channels that can be individually programmed to operate as ANI, DNIS, Tie, DID, loop start or ground start CO lines. This allows the system to connect to a CO, Long Distance Provider or another type of Key or PBX system with a T1 interface.

The T1 interface (via the RDTU2 PCB) provides economic advantages through the high-traffic carrying capacity of its 24 channels and the cost-effectiveness of its digital transmission facilities. This feature requires a customer-provided, UL listed CSU in most locations of the U.S. In Canada, a CSA certified CSU/DSU is required.

T1 interface users also benefit from the increased quality and no loss nature of digital transmission. Access to the T1 interface is completely transparent to station users. With DK424, Release 4.0, RDTU2 PCBs supports features, which require the hook-flash signal on T1 DID/DOD/Tie circuits.

Tandem CO Line Connections

This feature enables unattended line-to-line connections for the Strata DK, freeing the conferencing analog station or voice mail port for other calls and important tasks (see [Table 32 on Page 88](#) for feature system capacities).

- ♦ **DK14** enables up to two tandem connections
- ♦ **DK40i** enables up to three tandem connections
- ♦ **DK424** enables up to 10 tandem connections

When a tandem connection is set up with a [DN] only, the [DN] must appear on the originating DKT or EKT. With DK14 and DK40i, standard telephones and VM ports that set up a tandem CO line connection cannot release from the connection.

With DK424, Release 3.2 and above, standard telephones and/or VM devices can establish tandem analog CO line connections and then release them without disconnecting the tandem connection. After releasing from tandem call, reconnecting to the call can be accomplished by dialing an access code. This feature does not work if one or both of the CO lines are digital.

Tandem CO line volume level depends on the volume loss level of the Telephone Network CO lines (see [“Amplified Conference Interface” on Page 62](#)).

Tenant Service

Businesses in the same office building can share a system.

- ✦ **DK14** and **DK40i** each support up to two tenants
- ✦ **DK424** supports up to two tenants with RCTUA; all other processors support up to four tenants

Tenants can have separate LCR and Toll Restriction plans, Page Groups/Zones, Night Transfer ringing assignments, and flexible door phone and CO line ringing assignments.

Tie Lines

Tie lines can link the Strata DK40i or DK424 to other Strata DK systems or PBXs that support Tie lines. Incoming Tie line calls can be routed to ring a number of destinations within the Strata DK (see [Table 29 on Page 64](#)).

Analog Tie lines are interfaced via the REMU PCB, each of which provides four circuits. The interface options of Tie lines are: E & M Type I or Type II signaling, optional 2- or 4-wire transmission, Wink or Immediate start. Digital Tie lines, available with DK424, are provided by the RDTU2 and RPTU PCBs.

Tie lines do not reduce station capacity in DK424 Systems, Release 4.0. In DK40i, each Tie line reduces the station capacity by one.

CO lines transferred from Strata DK to another system over Tie lines will recall back to the originating Strata DK if the transferred call is not answered within a specified time (recall time is flexible for each station). The recalling station number may display on the LCD of the telephone being recalled.

An optional DTMF tone receiver PCB is required for Tie line operation:

- ✦ **DK14** does not support Tie lines
- ✦ **DK40i** requires the K5RCU tone receiver
- ✦ **DK424** requires the RRCS tone receiver

Toll Restriction

Stations can be individually restricted from making toll calls. Separate restriction levels can be defined, each allowing or denying specific area and office codes, long distance information calls, international calls, and/or operator-assisted calls.

Each station is assigned any one of the available restriction levels or no restriction. Individual lines can be defined as unrestricted. Restriction levels can also be assigned to verified account codes, which require a user to enter an account code before dialing long distance.

Toll Restriction Override by System Speed Dial

System Speed Dial numbers can be programmed to override Toll Restriction. When employees need to access a toll number that falls into a restricted area/office code for work purposes, an employer can assign the particular toll number as a System Speed Dial number. After overriding Toll Restriction with system Speed Dial, the caller can be blocked from or allowed to dial additional digits. Dialing long distance provider access codes (10XXX and 101XXX) is *not* allowed, except when entered via a System Speed Dial number or LCR.

Traveling Class of Service

The normal Toll Restriction class of a station can be temporarily changed to another class. Each of the Toll Restriction classes can be assigned a four-digit code.

If one of these codes is entered at any station, the station assumes the class associated with the code for the next dialed number. Then the station reverts back to its normal Toll Restriction class for subsequent calls. Traveling Class codes can be added, deleted, or changed by users from stations selected in programming.

Traveling Class codes will not appear on the SMDR reports. Verified account codes, which can also change Toll Restriction Class of Service, do print out on SMDR reports.

Unrestricted Call Transfer to Directory Numbers

Any CO, Tie or DID line or internal call can be transferred to any station [DN]. A station does not need a specific CO line's appearance in order to transfer or answer the call.

Voice First or Tone Signaling

The system can be programmed for either Voice First Signaling to [PDNs] or Tone First Signaling to [PDNs] as the standard method of internal [PDN] call signaling.

Tone Signaling is the commonly-used telephone ring when a call comes in. Tone Signaling better ensures privacy. With Tone Signaling, the called telephone receives a one-second ring tone every three seconds.

With Voice First Signaling, station users will hear a tone burst followed by the caller's voice over their telephone speaker when called by another station user. Voice First allows handsfree talkback from the called telephone on internal and private network Tie line calls.

When [PhDNs] are called, they always ring Tone first. Callers can always select the alternative method immediately after dialing a station number by dialing a **1**.

Voice Mail Integration

The system can be configured with a Toshiba Strategy, Strategy DK or VP (Voice Processing) or a customer-supplied voice mail messaging system. The following features are available with many of the systems.

Automated Attendant

Many voice mail systems offer AA as part of their overall feature package.

ANI/DNIS Routing to Voice Mailbox

Each DNIS number or all ANI numbers can be assigned to route directly to a voice mailbox independent of telephone user voice mailboxes. Routing ANI/DNIS calls directly to a voice mailbox can be set for all calls or just calls during a particular system mode (Day, Day2, or Night). This feature is available with in-band VM integration only, not with SMDI.

Call Forward to Voice Mailbox

Each telephone user can forward calls directly to a personal mailbox. The caller bypasses the usual sequence of voice mail commands and simply leaves a message after hearing a tone. Feature integration of special voice mail features in Strata DK software enables the systems to work together more efficiently.

The DK Systems provide SMDI or Inband DTMF tones for voice mail feature integration. These two options function independently of each other or together. All systems require a DK standard telephone port to interface with each Voice Mail port.

- ♦ **DK14** – the QRCU3 PCB enables DTMF. The WSIU PCB provides SMDI.
- ♦ **DK40i** – the K5RCU enables DTMF. TSIU, PIOU, PIOUS or RSSU PCBs enable SMDI.
- ♦ **DK424** – the RRCS enables DTMF. PIOU, PIOUS, RSSU or RSIU/RSIS PCBs enable SMDI.

Message Waiting Indication

When a message is recorded in a user's mailbox, the voice mail system automatically sets a message waiting indication—typically a flashing LED—at the user's digital or electronic telephone or the message waiting lamp on a standard telephone connected to an RSTU2 PCB.

A Toshiba telephone can have up to five message waiting buttons/LEDs. A fixed **Msg** button for the telephone's [PDN], and up to four (flexible) message buttons for each of the [PhDN].

Voice Mail Control via Station

On DK14 and DK40i, station users can control voice mail equipment from their telephone dial pads, when not connected in a conference call. With DK424, Release 3.2 and above, DK424 station users can control voice mail equipment on a conference call with other station's internal or external CO lines.

Table 31 Standard and Optional System Features

Standard System Feature	
Abandoned Call Numbers (ABR)	Multiple Directory Numbers
Account Codes (forced/voluntary/verified)	Multiple FCC Registration
Alternate Point Answer	Music-on-Hold (MOH) Interface
Automatic Release from Hold/DISA	Night Ringing Answer Code
Background Music Interface ¹	Non-blocking Talk Paths
Centrex/PBX Compatible	Outgoing Call Restriction
Centrex Ringing Repeat	Pooled CO Line Buttons
Conferencing	Pooled CO Release/Answer Button
Credit Card Calling	Privacy/Non-privacy
Day/Night Modes	Station Hunting
Delayed Ringing	Station Speed Dial
Distinctive CO Line/Directory Number Ringing	Station Relocation
Distributed Hunt (DK424 only)	System Programming through Station
DTMF Back Tone	System Speed Dial
DTMF and Dial Pulse CO Line Compatible	Tandem CO Line Connections
DTMF Signal Time (80/160 ms)	Tenant Service
Flexible Button Assignment	Toll Restriction
Flexible Directory Numbers	Toll Restriction Override by System Speed Dial
Flexible Line Ringing Assignment:	Transfer Recall (CO line and Tie line)
♦ Immediate	Traveling Class of Service
♦ Delay 1	Unlimited Handsfree Directory Number Talk Paths
♦ Delay 2	Unrestricted Call Transfer to Directory Numbers
Flexible Port/line Assignment	Voice First or Tone Signaling
Group Paging	Voice Mail Integration:
Least Cost Routing	♦ ANI/DNIS Routing to Voice Mail Box
Line Groups	♦ Automated Attendant
Line Queuing	♦ Call Forward to Voice Mailbox
Live System Programming	♦ Feature Integration
Memory Protection	♦ Message Waiting Indication
Message Waiting ¹	Voice Mail Control via Station
Optional Features	
Alarm Sensor ¹	Hospitality Management Information System (HMIS)
Alternate Background Music ¹	Integrated Services Digital Network (ISDN)
Amplified Conference Interface ¹	Loop Start CO Lines
Automatic Call Distribution (ACD) ¹	Modem Pooling ¹
Automatic Number Identification (ANI)	Night Ringing Over External Page ¹
Built-in Auto Attendant ¹	Night Ringing Over Selected Page Zones ¹
Caller ID ¹	Off-premises Station ¹
Computer Applications ¹	Power Failure Transfer ¹
Data Switching ¹	Printer Sharing ¹
Dialed Number Identification Service (DNIS)	Relay Service ¹
Direct Inward Dialing (DID) Lines	♦ External Page/Door Lock Control Relay
Direct Inward System Access (DISA)	♦ Night/Hold Relay
Door Lock Control ¹	Remote Administration and Maintenance ¹
Door Phones (MDFB)	Reserve Power ¹
Enhanced 911 (E911) Service ¹	System Program Administration Software ¹
External Page Interface ¹	Station Message Detail Recording (SMDR) ¹
External Page Zones ¹	Tie Lines
External Amplified Speaker ¹	Voice Mail Interface (SMDI)
Ground Start CO Lines	

1. Some feature implementation may require additional auxiliary equipment.

Table 32 System Feature Capacities

Features	DK424					
	DK14	DK40i	RCTUA	RCTUBA/ BB	RCTUC/D	RCTUE/F
Amplified Conferencing ¹	0	2	4	4	4	4
Auto Attendant (built-in) simultaneous calls in queue	3	5	12	12	24	24
Caller ID/ANI/CNIS Abandoned Call Numbers: stored per station	10~100	10~100	10~100	10~100	10~100	10~100
stored per system	200	200	200	400	1000	2000
CO Line Groups	4	8	8	8	16	16
Distributed Hunt (DH) Calls in Queue per Groups	10	10	10	10	10	10
DH Groups	16	16	16	16	16	16
DH stations per Group	8	28	32	32	32	32
DNIS Network Routing Numbers	0	100	100	200	300	300
DNIS Numbers	0	200	200	350	500	500
DTMF receivers	3	5	12	12	24	24
External Page Zones	0	4	4	4	4	8
Call Park Orbits - general	20	20	20	20	20	20
Call Park Orbits - individual	10	28	32	80	240	336
Personal LCD Messages per DKT ²	10	10	10	10	10	10
Personal Message DKTs	8	16	16	32	96	96
[PhDNs] per System	10	28	32	80	240	336
[PDNs] per System	10	28	32	80	240	336
Ring Tones	3	3	3	3	3	3
Simultaneous Party Conferencing (4-party)	2	3	3	7	7	14
Simultaneous Two-CO Line conferencing (3-party)	2	4	4	10	10	20
Station Speed Dial	40	40	40	40	40	40
Strategy DK Systems (per tenant group)	1	1	1	1	1	1
Strategy DK Systems (per system)	0	2	2	2	4	4
System LCD Messages	40	40	40	40	40	40
System Speed Dial	40	40	40	100	100	800
Telephone Page Groups	5	5	5	5	9	9
Telephone Group Page – simultaneous stations paged	8	28	32	80	120	120
Telephone Pickup Groups	8	20	20	20	20	20
Tenants	2	2	2	4	4	4
Toll Restriction (AC/OC) Table	8	8	8	8	16	16
Toll Restriction Classes	4	4	4	4	8	8
Verified Account Codes	300	300	300	300	300	500
Voice Mail SMDI	Yes	Yes	Yes	Yes	Yes	Yes

1. Requires additional customer-supplied hardware.

2. Personal Messages includes: timed reminder memo and station speed dial memo.

Table 33 Line Capacities and Universal Printed Circuit Board Slots

Lines and PCB Slots	DK424					
	DK14	DK40i	RCTUA	RCTUBA/BB	RCTUC/D	RCTUE/F
Universal slots	0	4 ¹	6	12	36	54
CO lines – loop start	4	12 ²	16 ²	48 ²	144 ²	200 ²
CO lines – ground start	0	12	16 ²	40 ²	136 ²	200 ²
DID lines (analog)	0	12	16 ³	40 ³	136 ³	200 ³
Tie lines (analog)	0	12	16 ³	40 ³	136 ³	200 ³
T1 (DS-1) lines each	0	0	0	48 ⁴	144 ⁴	192 ⁴
ISDN BRI B channel lines	0	12	8 ⁵	16 ⁵	16 ⁵	16 ⁵
ISDN PRI B channel lines	0	0	0	47 ⁶	141 ⁶	188 ⁶
Squared System Maximum (lines + stations)	4 lines + 4 stations	12 lines + 12 stations	16 lines + 16 stations	48 lines + 48 stations	144 lines + 144 stations	200 lines + 200 stations

1. There are four universal slots in the DK40i expansion unit.
2. All CO line capacities assume a PIOU, PIOUS, PEPU, RSSU, or RSIU is installed for RCTUBA/BB, RCTUC/D or RCTUE/F, but no Caller ID RCIU2/RCIS PCBs.
3. Limits apply to analog DID and Tie lines, not T1 DID/Tie lines.
4. T1 lines can be loop start, ground start, Tie, or DID (maximum 24 lines per unit, any type or combination).
5. BRI lines provide CO line services, including Caller ID, DID and Direct Inward Lines (DIL).
6. PRI lines provide CO line services, including Calling Party Number, DID, Tie, POTS, FX and DIL.

Table 34 Station and Peripherals Capacities

Stations	DK424					
	DK14	DK40i	RCTUA	RCTUBA/BB	RCTUC/D	RCTUE/F
Add-on modules (DADM)	8	12	12	40	120	200
Attendant consoles	0	0	0	2	4	4
DKT2004-CT Cordless Telephones	8	28	32	80	240	336
DKT2004-CT simultaneous calls	8	9	9	9	9	9
Door locks	2	3	4	5	5	5
Door phones	6	9	9	12	12	12
DSS consoles	0	3	3	4	8	8
ISDN BRI station circuits TE-1 and TA (2B+D per circuit) ¹	0	10	8	16	40	64
Handset;OCA stations	8	28	32	80	240	336
Off-premises stations	2	20	32	80	232	328
PDIU-DS ²	7	24	31	79	160	208
RPCI-DI used for data + TAPI, per system ²	8	24	32	80	144	200
RPCI-DI used for TAPI only: per cabinet ²	N/A	N/A	32	40	40	40
per system ²	8	24	32	80	186	280
Speaker OCA stations ²	8	28	32	80	160	208
Standard stations	2	20	24	72	232	328
Telephones – DKT	8	28 ³	32 ⁴	80 ⁴	240 ⁴	336 ⁴
Telephones – EKT	0	16 ³	32 ⁴	80 ⁴	240 ⁴	328 ⁴

1. ISDN BRI TE-1 and TA include ISDN telephones, modems, video conference interfaces, etc. Up to two stations (TE-1 and/or TA) can connect to and share one BRI S-type circuit. Only one station can connect to a BRI U-type circuit.
2. Speaker OCA, PDIU and RPCI capacity is determined by 2B channel slot availability and power supply limits.
3. To install the maximum of 28 total DKTs and EKTs in the DK40i, up to 16 of the stations can be EKTs and at least 8 of the stations must be DKTs.
4. Maximum capacity of DKT/EKT stations per DK424 cabinet is 62, less for EKT 2000, 3000 (Power Factor limitation).

Station Features

This chapter describes the features that are available to Strata DK station users. For an overview, see “[Station Features by Station Type](#)” on [Page 100](#). [Tables 34](#) and [35](#) list the station and peripheral capacities and station features.

Note Not all features for digital telephones are available on the digital cordless phones.

Account Code Button

This button, enables digital telephone users to enter Voluntary Account Codes (verified or nonverified), during conversations without interrupting the talk path. It can also be used to enter Verified Account Codes to allow normally restricted stations to dial long distance calls.

Add-on Module (DADM)

One to two DADMs can be attached to a DKT2000-series digital telephone to provide an additional 20 or 40 buttons (see “[Digital Add-on Module \(DADM\)](#)” on [Page 53](#)). DADM buttons can be programmed for outside line access, System or Personal Speed Dial, or Direct Station Selection ([Appendix – Table 42 on Page 115](#)).

Alert Signal Button

This feature enables a digital or electronic telephone user to signal a predesignated station. When the **Alert Signal** button is pressed, a distinct tone signal is sent to the dedicated station. This signal can be used to alert someone about a pre-arranged event or action—No talk path will exist between the called and calling telephones.

An alert signal can be sent to telephones that are idle, or Busy, Call Forward, and/or Do Not Disturb mode. Each station that has this feature can send/receive the alert signal to/from the other station in the alerting pair. Up to four unique **Alert Signal** buttons can be on a station.

Automatic Busy Redial (ABR)

Digital and electronic telephone users who dial a busy outside telephone number can set ABR, which automatically redials the number at preprogrammed intervals. Busy tone must consist of standard tones. The system will call back the station when it rings the number. ABR is compatible with LCR and ISDN, but is not compatible with outgoing DID or Tie line calls. ABR requires the QRCU3 on DK14 and K5RCU option PCB for the DK40i; it is standard on the DK424.

Automatic Callback (ACB)

Station users that call busy or Do Not Disturb (DND) stations can set ACB and have the system call them back when the busy or DND station or trunk group becomes available. When calling a station with multiple [PDNs] in the ring first mode, ACB will be available to the calling station only if all the [PDNs] of the called station are busy.

Automatic Hold

This option enables a user to place a CO **Line** or [DN] call on Hold by pressing another CO **Line** or [DN] button. The user can then alternate between the new and the old call by pressing the desired **Line** or [DN]. If this feature is not activated, users must press **Hold** before accessing another line and switching between calls.

Automatic Line Selection

A digital or electronic telephone user with this programmable feature automatically accesses an outside line, a line group, and an internal [PDN] line whenever the handset is lifted or the speaker (**Spkr**) button is pressed.

Background Music (BGM) with Station Control

Digital telephone users can control BGM playing over their telephone speakers. (Only a designated station can control BGM over External Page speakers.) Besides being able to turn the music on or off, users can also adjust the volume level. The Cordless DKT-2004-CT attached to a DKT is not compatible with BGM.

Busy Override

Enables a station user to send tone bursts to a busy station's idle [DN] or **CO Line** button by dialing a **2** or pressing a feature button. The tone burst can either be sent two times (four seconds apart) or repeated continuously every four seconds. If there are no idle [DNs] or line buttons on the busy station, the station will receive two bursts of camp-on tone (see [“Call Transfer with Camp-on” on Page 93.](#))

The busy station can be a digital or electronic and receive this tone. The DKT2000-series telephone users can adjust their telephones to receive the tone over their handset or headset receiver, as well as the speaker. Standard telephones will receive camp-on tone twice from the handset receiver (it is not continuous on standard phones).

Busy Station Transfer/Busy Station Ringing

The Busy Station Transfer and Busy Station Ringing features operate together to ensure that a busy digital or electronic telephone station always receives transferred calls along with distinct LED and tone indications. A typical application is when an AA device transfers calls frequently to a busy answering position station.

Call Forwarding

Outside CO Line and internal [DN] calls to stations in the Call Forwarding mode are routed to an alternate station or voice mail device. Stations in this mode can originate calls as usual. Call forwarding can be set by a feature button or access code.

Station users can set Call Forward for the telephone's [PDN] or the [PhDN] that is “owned” by that telephone. The Call Forward destination mailbox can be different for each [PDN] or [PhDN]. LCD telephones display the forwarded [DN] and the “forward to” destination.

On DK424, Release 3.2 and above, a telephone can be designated as the Call Forward controlling telephone in applications that require ground and loop start CO lines to ring a group of telephones. In DK14 or DK40i, and prior releases of DK424, CO lines that ring more than one telephone do not Call Forward.

To Call Forward in a particular ringing assignment (immediate, 12-second delay, 24-second delay), the Call Forward control telephone must be the only one designated to ring in the ringing assignment. If the call forwards to voice mail, it is sent to the mailbox controlling telephone's [PDN] or designated [PhDN]. There are six Call Forwarding modes:

All Calls

This mode forwards all calls to a busy or idle [DN] immediately; the station will not ring.

Busy

When this mode is set, all calls to a busy [DN] immediately forward. If a station has an idle [PDN], but is busy on another [DN] or CO line call, calls to the [PDN] will not forward if the system has Ring First signaling, but they will forward if the system has Voice First Signaling. If all the station's [PDNs] are in use, then calls to the [PDN] will forward immediately. When a station is in the DND mode, all calls to the station's [PDN] forward immediately, if the [PDN] does not appear on other stations.

No Answer

Calls to an idle [DN] set with this mode will ring for 8 to 60 seconds and then forward. The Ring No Answer time (8 to 60 seconds) can be set by the telephone user. Call Forward No Answer (CFNA) is optional on Handsfree Answerback.

Notes

- OCA calls will not Call Forward.
- Handsfree internal calls can be programmed to automatically forward if there is No Answer. If this is not programmed, callers can force Call Forward with a one-digit entry.

Busy/No Answer

When a station is idle and in this mode, calls will ring for 8 to 60 seconds and then forward. The Ring No Answer time can be set by the telephone user. When all the station's [DNs] are busy or when the station is in the DND mode, the call will "Call Forward-busy" immediately.

On Ring First systems, if the station is busy on a call, but has an idle [DN], calls will mute-ring the idle [DN] until the CFNA timer expires and then the call will forward. This allows other users to answer the call if the called [DN] appears on their telephones. On Voice First systems, calls will immediately Call Forward-busy when the station is busy on a call, even if it has an idle [PDN]. A station in the DND mode will call forward immediately.

Fixed

Calls to the [PDN] or private CO line of an idle or busy digital or electronic telephone in this mode will forward immediately to a destination assigned in system programming, but not as defined by the telephone user.

External Call

Users can set their stations to forward incoming calls (on private or DID lines) to numbers outside the DK System. The forwarding destination can be cancelled or changed to another outside number or an internal voice mailbox (either remotely via DISA or from the user's telephone, security code protected). Internal, Tie line, and transferred calls will not call forward externally, but can forward internally if another Call Forward mode is set simultaneously with Call Forward-external.

Note Call Forwarding can be set for [PDNs] and [PhDNs] individually, with the exception of Call Forward External and fixed Call Forward which applies only to [PDNs].

Call Park Orbits

The Call Park feature enables a station user to place a call temporarily in an orbit so that the call can be retrieved by any user, either from the same station or from a different station. There are 20 General Park Orbits for the system and one Personal Park Orbit for each station. Personal Park Orbits are available to any type of telephone, including standard telephones.

If a call is parked, but not retrieved within a preprogrammed time period, it will recall the parking telephone. The Park recall time is set individually for each station.

Park and Page

This feature enables a user to park a call (in a General or Personal Park Orbit), enter a Page Zone or Group access code, and then announce the orbit number of the waiting call to the Paged party. A pre-programmed flexible button can be assigned to telephones to automatically connect to a predesignated External Paging circuit, a Telephone Paging group or both.

Auto Park

This feature is only available to LCD telephones. When a telephone user parks a call, the user can enter **999** instead of a specific Orbit Number. The system will then automatically select the next available General Park Orbit and park the call. The parking telephone's LCD will show the Park Orbit that has been automatically selected for the parked call.

Call Pickup

By pressing a button or by going off-hook and dialing an access code, any station can pick up the following type of calls:

- ♦ [PDN] or [PhDN] calls on hold or ringing at other stations
- ♦ CO/DID/Tie lines calls ringing at other stations, either all lines or designated lines. (See “Tenant Service” on Page 84.)
- ♦ External or Station Group Page
- ♦ CO line ringing during the Night mode over External Page or night bell
- ♦ Door phone calls
- ♦ Incoming CO line calls
- ♦ Parked calls
- ♦ Any ringing line or designated Tenant Group lines
- ♦ Tandem CO line connections (by tandem origination telephone)

Call Pickup Groups

Up to 20 Call Pickup groups can be created to enable station users to pickup calls ringing at other stations with the touch of a Pickup feature button or by dialing brief access codes.

Station users can pick up a call that is ringing or transferred to any station in their own group with a single access code or feature button, and can pickup calls ringing stations in other groups with selected codes. Any station can be in all the different pickup groups.

Call Transfer with Camp-on

A station user can transfer a CO, DID, or Tie line or internal call to a busy station, which will receive an alert tone indicating that a call is camped-on. If the busy station fails to answer, the camped-on call will recall the transferring station.

A camp-on tone is also sent to electronic or digital telephones that are busy and that do not have an idle [DN] or **Line** button to receive the call. Camp-on tone consists of two tone bursts, followed by silence. It can be enabled or disabled for each individual station.

Call Transfer Immediate

For Digital LCD telephones: If the Feature Prompting Soft Key is used to transfer a call, the call immediately transfers after the last digit of the destination is dialed. If the called station is not available or is busy, the call automatically camps-on to it. This feature is helpful to people who process a large number of calls with no time to wait for transferred calls to be answered.

Call Transfer Music or Ringing Option

This feature enables ringing or music to be heard by the caller when a call is transferred, depending on system programming. Prior to Release 3.2, callers heard music during the transfer process and no ringing option in programming was available.

Call Transfer Recall

CO, DID, or Tie lines that are transferred (internally or over Tie lines) will recall to the transferring station if the called station does not answer. The recall time is individually set for each transferring station.

Centrex/PBX Features

System Speed Dial buttons can be programmed with access codes, plus any flashes or pauses necessary to access features through a host switching system.

Conferencing

A variety of Conferencing combinations are available to all station users, as listed below. Stations and lines can be added in any order. (See “[Amplified Conference Interface](#)” on [Page 62](#) for more information.)

- ◆ One or two stations and two outside lines
- ◆ Two or three stations and one outside line
- ◆ Four stations on one internal [DN] line
- ◆ Three to four simultaneous Conference calls ([Table 32 on Page 88](#)).
- ◆ Voice Mail plus one station and two other parties (internal or outside line for DK424, Release 3.2 and above. (Outside line must be analog, not digital.)

Continuous Dual-tone Multi-frequency (DTMF) Tone

The DTMF dial signal sent to an outside line or voice mail/auto attendant device can continue as long as a DKT2000-series digital telephone user presses a button on the dial pad. This feature is not available with electronic or DKT1000-series digital telephones.

Data Call Button

A flexible button on a digital telephone can be assigned as a **Data Call** button, which can be used to dial internal data calls. The telephone must be equipped with an RPCI-DI for **Data Call** button applications.

Direct Station Selection (DSS) Buttons

Digital telephone users can ring selected stations by pressing a flexible feature button assigned for a DSS function. The LED associated with the button provides the busy status of the station and the station's [PDN]. Each flexible button can be assigned as a DSS button to a different station [PDN]. DSS buttons can also be assigned on DADMs.

Direct Station Selection (DSS) Console Features

On DK40i and DK424, digital and electronic telephones can operate with DSS consoles, which offer the following features:

- ◆ Automatic CO line Hold

- ◆ Feature buttons
- ◆ All Call Voice Page
- ◆ Outside Line access buttons
- ◆ DSS with busy LED indication
- ◆ Night Transfer
- ◆ Speed Dial
- ◆ Voice First or Tone Signaling
- ◆ Call Forward Override

Directory Number [DN] Buttons

These are the telephone's call buttons, used to originate and receive internal and external calls. See ["Multiple Directory Numbers"](#) on [Page 76](#) for information on the different types of [DNs].

DISA Security Code Revision

Certain digital telephones selected in programming can revise the DISA security code.

Distinctive LED Color and Flash Indications

- ◆ Outside CO **Line** and [DN] button LEDs light red or green to help digital telephone users determine the status of calls. Electronic telephone LEDs are always red when they light.
- ◆ Digital and electronic telephone LEDs flash at varying rates to indicate calling status.

Distinctive Station Ringing

Digital and electronic telephones can have one of three different ring tones for incoming CO and DID line calls to help distinguish incoming calls. Also, ring tones for transferred CO and DID line calls are different from the ring tones of direct CO line calls to the same telephone.

Do Not Disturb (DND)

Station users with digital telephones can activate DND to prevent any calls from ringing them. Callers will hear a fast busy tone. If a DND station's [DN] appears on other telephones, callers will ring the [DNs] on those other telephones. The [DN] will then flash on the DND station, but it will not ring. Stations in DND mode can originate calls. Also, Call Forward-Busy will operate on a DND telephone, even if the telephone has idle [DNs].

Do Not Disturb (DND) Override

Stations with this special feature programmed can override stations in the DND mode with a tone that indicates that somebody is trying to contact them.

DP/DTMF Mode Change

This feature allows digital and electronic telephone users to change the line out-dialing signal mode from Dial Pulse (DP) to DTMF with the touch of a feature button.

Exclusive Hold

Exclusive Hold enables a digital telephone user to place a call on hold so that the call can only be picked up at that station or at another station using Directed Call Pickup. No other station can pick up the call by simply pressing the [DN] or line button that the call is being held on.

Executive Override

Stations with this feature programmed can enter any conversation, except ACD and ACD/PBX calls, in the system by dialing an access code or pressing a Feature Prompting Soft Key. An optional warning tone notifies the parties that another party is about to conference into their conversation. Executive Override can be blocked selectively to any station in system programming for security with modem (data) calls, voice mail calls, fax machine calls, etc.

Feature Prompting with Soft Keys

As an alternative to dialing access codes and using feature buttons, station users with LCD digital telephones use Soft Keys (shown on their LCD) to access features. Abbreviated feature names appear during a call (when the telephone is in the ring or talk state) on the LCD above fixed keys. Users can select a feature by pressing the associated key. The LCD feature selections change according to the call state to provide the most logical options.

Flash Button

An optional button on a digital or electronic telephone can be used either to disconnect a line and regain CO dial tone, or to gain access to Centrex features. The timing choice is system-wide by system programming.

Handsfree Answerback

When a voice-announced internal [DN] call comes in to a digital or electronic telephone, users can answer without lifting the handset. The Cordless DKT-2004-CT and standard telephones are not compatible with this feature.

Hearing Aid Compatible

All Toshiba digital telephones are hearing aid compatible.

Liquid Crystal Display (LCD) Features

LCD model telephones provide a number of features, such as: ANI, Caller ID, CO Line Identification, DNIS, and more. See [Table 26 on Page 50](#) for a list of LCD features.

Microphone Cut-off Button

Digital telephones can be programmed with a Microphone Cut-off (**Microphn Cut-off**) button to turn the microphone inside the telephone on and off while idle. This “push-on/push-off” button enables/disables Handsfree Answerback to the telephone. When Microphone Cut-off is on, it blocks room monitoring and Hands-free Answerback.

Modem Button

This button enables a digital telephone user to reserve a modem from a pool or to switch from a voice to a data call. Its LED indicates the availability of modems. The telephone must be equipped with an Integrated PC Interface Unit (RPCI) for **Modem** button applications.

Modular Handset and Line Cords

All Toshiba telephones are equipped with modular handset and line cords.

Modular Headset

Digital telephones may be optionally equipped with a modular headset jack by installing an HHEU PCB.

Off-hook Call Announce (OCA)

OCA allows a station user to send a voice announcement to a busy digital or electronic telephone. The call must be directed to a station's [PDN] or [PhDN]. OCA will not occur when the called station is not the owner of the dialed [PDN] or [PhDN]. Only the [PhDN] owner telephone can receive OCA on calls to the [PhDN].

In order for a station to receive OCA, the station must be assigned with OCA-receive capability in the system database. Depending on system programming and hardware availability, the called station can receive OCA in one of the following ways:

Handset Mode

An OCA announcement can be sent through the handset receiver to called party who is off-hook and engaged in a conversation. Only digital telephone sets can have this feature. If the called party's station has been programmed with Handset Mode and OCA-receiving capability, an OCA warning tone (optional) and announcement can be sent to through the handset. The Cordless DKT-2004-CT will also receive the warning tone and announcement.

The called station user, while off-hook and engaged in a conversation, will hear the outside talking party and the OCA calling party, but the outside talking party cannot hear the OCA calling party. The called station user can hold down the **Mic** button to respond and talk to the OCA calling party through the handset; the outside talking party will not hear the response.

A digital telephone feature button can be programmed to work with "push-on/off" action. When "push-on/off" is used, the outside party will hear MOH, if installed, when the called party talks back to the OCA party; otherwise, the outside party hears nothing when excluded from the talk path. Receiving handset OCA calls is available to digital telephones only; no special hardware additions are required.

The DKT2001 telephone can receive handset OCA announcements, but the user cannot respond, since the DKT2001 does not have **Mic** button.

Speaker Mode

An OCA announcement can be sent through the speaker to a called party who is off-hook and engaged in a conversation. The called phone user must be equipped with a digital telephone with the optional DVSU PCB and the station must be programmed for OCA-receiving capability. The Cordless DKT-2004-CT telephone is not compatible with Speaker OCA.

The called station user can respond to the OCA caller by talking into the telephone's microphone. With more than one party connected, two-way simultaneous conversations are possible. However, the RPCI PC/Data Interface cannot be used if speaker mode OCA is installed or vice versa. Electronic telephones are compatible with speaker OCA (optional hardware is required).

On-hook Dialing

Digital and electronic telephone users can dial calls without lifting the handset, freeing their hands for other tasks. System dial tone, dial pulsing, ringing, and the voice of the answering party are all heard over the telephone speaker. The handset does not need to be lifted until after the party answers, and on speakerphone models does not need to be lifted at all.

Personal Computer Interface (RPCI-DI)

An optional PC interface unit that replaces the normal digital telephone base and provides the telephone with simultaneous computer-telephone interface and voice/data features as described in “[Integrated PC Interface \(RPCI-DI\)](#)” on [Page 53](#).

Pooled Line Buttons

A group of CO lines can appear under one button on digital and electronic telephones. The system can support up to 16 line groups. A station can have up to four buttons for the same group for handling calls in the same group. Pooled and single appearing line buttons are designed for use with loop and ground start lines, not Tie, DID, DNIS, or ANI lines.

Private CO Lines

The system can be programmed to allow certain “private” CO lines to appear only on one digital or electronic telephone and is accessible only by that station.

Push-button Dialing

All Toshiba telephones are equipped with push-button dial pads.

Release Button

Users can complete a transfer or disconnect from a call and become idle just by pressing an optional **Release** button on their digital telephones; going on-hook or pressing the hookswitch is not required. This feature is useful for headset-equipped stations.

Release/Answer Button

The **Release and Ans** button enables a station user that is talking on a call to release and transfer or disconnect the active call and automatically answer a new incoming call. This is useful for DSS console’s telephones or stations that must process many incoming calls.

Remote Retrieval of Held/Parked Calls

Calls placed on hold or parked by a station can be picked up selectively by another station by pressing a feature button or dialing an access code.

Repeat Last Number Dialed

The last number dialed by a digital or electronic telephone is stored in system memory, and may be redialed automatically by accessing a CO line and pressing the **Redial** button or dialing an access code.

Ringling Line Preference

A digital or electronic telephone user with this programmable-by-station feature can answer an incoming CO, DID, or Tie line call ringing at their station just by lifting the handset or pressing the **Spkr** button, without having to press the button associated with the line.

Saved Number Redial

After dialing a telephone number, a digital telephone user can “save” the number by pressing an optional feature button. The system will automatically redial the saved number when the user accesses a [DN] or CO line and presses the button again.

Speed Dial Buttons

This feature enables digital station users to dial telephone numbers with the push of a button. Standard telephones can dial System and Station Speed Dial numbers with access codes. There are two types of Speed Dial buttons:

- ♦ **Station Speed Dial Buttons** – Station users can store their own personal telephone numbers on Station Speed Dial buttons. Each button uses one of the assigned 40 station speed dial number storage locations.
- ♦ **System Speed Dial Buttons** – A designated station user can store numbers for System Speed Dial buttons, which can be assigned to any digital or electronic telephone. For the number of available system speed dial numbers, see [“System Speed Dial” on Page 81](#).

Telephone Application Programming Interface (TAPI) Compatibility

The DK can interface with computer applications which conform to the Microsoft Windows TAPI format. TSPI software, which allows the DK to communicate with TAPI applications, is bundled with the RPCI in the form of a 3-1/2” IBM-compatible disk.

The TAPI connection is made with a customer-supplied RS-232 cable connected to a communication port on a PC and through a DKT2000-series digital telephone with an installed RPCI. The PC must be able to run Microsoft Windows software.

Timed Reminders

Five separate “reminders” (i.e., a tone which sounds at a preset time) can be set at any telephone to ring only once or at the same time daily.

Toll Restriction Override Code Revision

Privileged digital telephone stations can change Toll Restriction Override Codes.

User Programmable Feature Buttons

This feature enables digital and electronic telephone users to program their personal Speed Dial buttons with codes to access features and/or dial telephone number. As many as 20 digits and button functions—such as Hold, [PDN] access, and Conference/Transfer (2 digits each)—can be stored. More than one feature can be linked under one button to allow functions like placing a line on hold and accessing the Page system with the touch of one button.

Features

Station Features

Table 35 Station Features by Station Type

Feature	DKT	DKT2001	Digital Wireless	Cordless	EKT ¹	ST & Analog Wireless	Standard Feature
Account Code Button	X		X	X	X		X
Account Code Revision	X	X			X		X
Add-on Module (DKT2000-series only)	X						
ANI/Caller ID	X ²			X	X ²		
Alert Signal Button	X				X		X
Automatic Busy Redial (ABR)	X	X	X	X	X		X ³
Automatic Callback (ACB)	X	X	X	X	X	X	X
Automatic Hold	X		X	X	X		X
Automatic Line Selection	X	X	X	X	X		X
Background Music with Station Control ³	X	X			X		X
Busy Override (receive)	X		X	X	X		X
Receive over Handset/Headset	X	X	X	X			X
Busy Station Transfer/Busy Station Ringing	X	X	X	X	X	X	X
Call Forward:							X
All Calls	X	X	X	X	X	X	X
Busy	X	X	X	X	X	X	X
No Answer	X	X	X	X	X	X	X
Busy/No Answer	X	X	X	X	X	X	X
Fixed	X	X	X	X	X		X
External Call	X	X	X	X	X	X	X
Call Park Orbits:							X
Park/Page	X	X	X	X	X	X	X
Auto Park/Page	X ²				X ²		X
Orbit Lists	X ²				X ²		X
Call Pickup:							X
Night Bell	X	X		X	X	X	X
Tenant Ringing Lines (4-Groups)	X	X	X	X	X	X	X
Station Groups (20-Groups, All Call Types)	X	X	X	X	X	X	X
Any Ringing Line	X	X	X	X	X	X	X
Directed Station (All Call Types)	X	X	X	X	X	X	X
Held CO Lines (Selectively)	X	X	X	X	X	X	X
Door Phone	X	X	X	X	X	X	X
Parked Call	X	X	X	X	X	X	X
External Page	X	X	X	X	X	X	X
Call Transfer with Camp-on	X	X	X	X	X	X	X
Call Transfer Immediate	X						
Call Transfer Recall	X	X	X	X	X	X	X
Centrex/PBX Compatible	X	X	X	X	X	X	X
CO/Centrex Feature Buttons	X		X	X	X		X
Conferencing	X	X	X	X	X	X	X
Continuous DTMF Tones	X	X					X
Data Call Button ⁴	X						
Direct Station Selection Buttons	X			X	X		
Direct Station Selection Console Features	X				X		X
Directory Number Buttons	X	X		X	X		X
DISA Security Code Revision	X				X		X
Distinctive Ringing - CO vs. Station	X	X			X	X	X
Distinctive Ringing - Station (for CO calls)	X	X			X	X	X

DKT – Digital Telephone
EKT – Electronic Telephone
ST – Standard Telephone

Table 35 Station Features by Station Type (continued)

Feature	DKT	DKT2001	Digital Wireless	Cordless	EKT ¹	ST & Analog Wireless	Standard Feature
Do Not Disturb (DND)	X			X	X		X
Do Not Disturb Override (receive)	X		X	X	X		X
DP/DTMF Mode Change	X			X	X		X
Exclusive Hold	X	X		X	X		X
Executive Override	X	X	X	X	X	X	X
Feature Prompting with Soft Keys	X						
"Flash" Ability	X	X	X	X	X	X	X
Flexible Buttons	X			X	X		X
Handsfree Answerback	X				X		X
Headset Interface ³	X		X	X	X		
Headset Receiver Volume Control ³	X		X	X			X
Hearing Aid Compatible	X	X	X	X	X		X
LED - Distinctive Indications	X			X	X		X
LED - Dual Colors	X						X
Liquid Crystal Display	X		X	X	X		
Message Waiting Indication	X	X	X	X	X	X ³	X
Multiple Message Waiting	X	X		X	X	X	X
Microphone Control Button (fixed)	X				X		X
Microphone Sensitivity Control by User	X						
Modem Button	X						X
Modular Handset and Line Cords	X	X			X		X
Modular Headset/Loud Ringing Bell Interface	X				X		
Night Lock	X				X		X
Night Transfer	X				X		X
Off-hook Call Announce - Handset Mode	X	X ⁵	X	X			X
Off-hook Call Announce - Speaker Mode	X				X		
Off-premise Station						X	
On-hook Dialing	X				X		X
Page Access	X		X	X	X	X	X
PC Interface - Telephone Application Program Interface (TAPI) Compatibility	X						
Phantom Message Waiting Indication	X			X	X		X
Pooled Line Buttons	X			X	X		X
Private CO Lines	X	X		X	X		X
Push-button Dialing	X	X	X	X	X		X
Release Button	X			X	X		X
Release/Answer Button	X			X	X		X
Remote Retrieval of Held/Parked Calls	X	X	X	X	X	X	X
Repeat Last Number Dialed	X	X	X	X	X		X
Ringing Line Preference	X		X	X	X		X
Saved Number Redial	X		X	X	X		
Speed Dial Buttons	X			X	X		
Timed Reminders	X	X			X		X
Toll Restriction Override Code Revision	X	X			X		X
Two CO Line Conference	X	X	X	X	X	X ⁶	X
User Name Display	X		X	X	X		X
User Programmable Feature Buttons	X			X	X		X

1. Does not apply to DK14.
2. For LCD EKTs and DKTs.
3. Standard on DK424; optional on DK14 and DK40i.
4. May require customer-supplied hardware.
5. The DKT2001 can receive handset OCA, but cannot respond (no 0LF button).
6. Not applicable on DK14 or DK40i. DK424 requires software Release 3.2 or higher.

PC Attendant Console Features

The Strata DK PC Attendant Console (DK-PCATT) offers many new features, not available on the older model DK Attendant Console (see [Table 36 on Page 108](#)). Additionally, it offers most of the features available on digital telephones and the older DK Attendant Console. Most features can be operated either from the DK-PCATT-KB keyboard or from a PC mouse.

Note For minimum requirements and an illustration of the DK-PCATT screen, see [“PC Attendant Console \(DK-PCATT\)” on Page 57](#).

The following describes specific console features that are available to DK-PCATT users.

Answer Button

Automatically answers the next ringing call based upon the system defined priority (incoming CO, recall, transferred, etc.—see Answer Priority). Multiple ringing calls are automatically queued to the **Answer** button. The system can prioritize on a first-in first-out (FIFO) basis, or according to the priority defined by the user with the Answer Priority feature.

Answer Priority

Enables the **Answer** button to answer multiple ringing calls in a priority sequence. The priority sequence is programmable except for emergency calls, which are always the highest priority. The program default priority sequence is (highest to lowest) Emergency Call, Park Orbit Recall, Transfer Recall, Hold Recall, Transferred to “O” Call, Incoming CO Line Call, Internal “O” Operator Call, Internal to Operator Directory Number [DN] Call.

Answer Prompting

When an incoming call rings the console, the screen displays can display prompts for answering the various CO line or DNIS call. These prompts are stored from the console.

Attendant Conference Setup

This enables the Attendant to set up a conference call with up to four members. Conference members can be another console, station, or CO line user. The conference can be originated by the Attendant or requested by a station user or outside party.

Auto Day/Night Mode Switching

The DK-PCATT can automatically switch the Strata DK between Day, Day2, and Night modes, according to the time of day and day of week. Parameters are programmed from the attendant console. With automatic mode switching, the **Night Transfer** button does not have to be pressed. Automatic mode switching is only available with a DK-PCATT and is not a standard system feature of the Strata DK.

Auto Dialing

When Auto Dial is on, the DK-PCATT can search for names and numbers in the directory, and then automatically dial the number. If Auto Dial is off or no match is found, the Attendant can use the directory and press a button to call a party or enter a number to be dialed.

Busy Lamp Field (BLF) Display

The console screen shows station status (busy/idle), so the Attendant can see who is busy. BLF data displays in the directory area of the screen, either with or without station names.

Call Waiting Count

The number of calls waiting to be answered in the attendant console answer queue is displayed and constantly updated.

Color CRT Display

Console text information is displayed on the monitor screen in full color. Various colors indicate different status or conditions, making them more distinguishable to the Attendant.

Dial “O” For Attendant

Up to four attendant consoles can be installed per system. To call any available console, station users dial O. To call a specific console, dial the specific console [DN].

Dial Outside Number For Station User

The Attendant can access a CO line and dial an outside destination number for a station user. To do this, the Attendant must be in the talk state with a station user, an outside caller, or a caller on an incoming Tie trunk.

Direct Station Selection (DSS)

The Attendant can make direct station calls or transfers by pressing a button, or pointing and clicking the mouse button on the station name or number on the internal directory screen.

Directory Display and Dialing

The directory listing area of the screen can display both names and numbers of internal station users. The Attendant can point and click on a name to automatically dial the number.

- ◆ The Internal Directory displays the names, directory numbers, and station status (busy/idle) of station users and ACD groups. This facilitates quick and easy call processing, primarily transfer of incoming calls.
- ◆ A scroll bar enables the Attendant to quickly scan all of the names in the directory listing.

DTMF Signaling from Dial Pad

The Attendant can press a button to send DTMF tones from the dial pad. DTMF tones are used to signal external devices such as voice mail, auto attendants, answering machines, etc.

Emergency Calls

Emergency calls from internal stations that arrive at an attendant console receive higher priority call treatment than other calls. Emergency calls display in the incoming call area of the screen. If the call is placed on hold, hold time appears in red to highlight this call for quick retrieval.

Emergency Page

An attendant console equipped with an assigned **Emergency Page** button can Page the All Call Page group. The Page sounds over the speakers of all idle telephones in the All Call Page group, but does not sound over the external paging speakers.

Feature On-Line Help

On-line Help provides feature instructions at the touch of a button or a click of the mouse. It functions the same as other Windows PC applications. On-line Help provides more details than the Soft Key feature prompts. For even more detailed explanations and instructions, refer to the *Strata DK PC Attendant Console User Guide*.

Feature Prompting with Soft Keys

Feature Prompting with Soft Keys provides access to various console features. On-screen instructions and Soft Key functions change according to the state of the Attendant Console.

Examples are:

- ♦ Sending a message waiting indication to a station
- ♦ Breaking into an ongoing conversation
- ♦ Performing a transfer, conference, or voice page

Flexible Programmable Buttons

There are 16 flexible buttons on the display screen which can be programmed with a variety of feature assignments, trunk access, or as Incoming Call (In) buttons.

Headset Operation

In addition to the handset, the console can be used with a headset. The headset can be plugged into the RATI attendant console interface unit.

Hold Button

When the **Hold** button is selected, the current call is placed on hold. If the call is not answered within a preprogrammed time period, the Attendant is reminded by an on-screen ring indicator.

Hold Timer Display

The timer information screen shows the amount of time each call has been on hold. This serves as a reminder for the Attendant, ensuring that the held calls will not be ignored or forgotten. Also, the color indicates whether the call is on Hard Hold, Consultation Hold, Supervised Hold, or Emergency Call Hold.

Incoming Call Identification

This feature enables selective answering of all categories of calls to the Attendant (internal [DN], transferred, park recall, hold recall, transfer recall, emergency, operator, and incoming CO for all 16 CO line groups). The Attendant can select and answer calls in the incoming call display area, instead of using the **Answer** button. Thus, the Attendant can override the FIFO or priority order established by the **Answer** button and the Answer Priority feature.

Incoming Call Statistics

The DK-PCATT collects incoming call statistics, such as the number of calls received per hour, total talk time (in seconds) per hour, total incoming talk time per hour, total waiting time (in seconds) in queue per hour, and the maximum number of calls in queue each 15-minute interval. The data is stored on disk for display or printing. Today's data can be displayed on screen and the previous day's data can be printed.

Interposition Call Transfer

This feature allows calls to be transferred from one attendant console to another.

Join Button

Allows the Attendant to connect an incoming call with an outside party on hold or an internal station. Rather than transferring the call, the Attendant presses the **Join** button to create a temporary conference from which the Attendant can drop out.

Keyboard or Mouse Operation

Most of DK-PCATT functions can be operated by clicking a mouse on screen buttons or by pressing the equivalent keyboard buttons. Attendants can choose the easiest method for them.

Load Sharing

In a multiple-console environment, incoming calls are distributed among the available consoles (up to four) on a call-by-call rotation basis, which increases efficiency and call coverage flexibility.

Loop Hold Display

This display lists the calls on hold and the hold time. If a call is not answered within a preprogrammed time, it recalls with a ring indicator and appears on the Incoming Call display.

The console can be set for Supervised loop operation, which keeps the call in the Loop display even after it's transferred, enabling the Attendant to monitor it or re-enter the conversation. With release loop operation, the held call appears briefly in the Loop display area until it is answered by the station receiving the transferred call. Then it disappears from display.

The Attendant can type a note, such as who the call is for, the caller's name, etc., while still connected to the call. This note is associated with the call so that Attendant can provide personal attention to each caller.

Message Center

The Attendant can use the DK-PCATT keyboard to enter a message into the message database. When a message is entered, the station's message light is automatically lit. At a later point, the station user can press **Msg** and call the Attendant. If the station is an LCD phone, the display will show that the Attendant called. Once the station user is connected with the Attendant, the Attendant can display a list of messages for that caller and read them back.

Multi-tasking

The Strata DK-PCATT software runs as a standard Windows application. Toshiba recommends using a dedicated PC for the console to maximize response time and efficiency. However, other applications can be run simultaneously on the same PC, enabling the Attendant to use the PC for multi-tasking purposes.

When call traffic is light, the PC can toggle from the Attendant Console mode to another application. If a call is received while in another application, the PC can immediately switch back to Attendant Console mode to handle the ringing call. The DK-PCATT can be set to toggle automatically (Auto Activate on) or manually.

Name or Number Dialing

The DK-PCATT directory can include individuals who do not have stations within the system. This accommodates personnel located off-site (in other facilities, working at home, etc.). The directory can include information on reaching these people. It also provides an area for entering messages for them.

The Attendant can use the directory to select parties by name, number, or department. If Auto Dial is on, a matching name or number invokes automatic calling or transferring. A department list shows the names and/or numbers of people within a department.

Overflow

Calls that have been waiting in the ringing queue too long will be re-routed to another console, station, or answering device. This feature is controlled by the overflow timer, and can be manually activated by the Attendant during high-traffic conditions via the **Overflow** button.

Override

There are three different ways to override calls:

- ♦ Busy Override lets the Attendant send a tone to a busy station to signal a call is waiting.
- ♦ DND Override lets the Attendant send a tone to an idle station in the DND mode to indicate that an important call is coming in.
- ♦ Executive Override lets the Attendant enter an established conversation.

Position Busy Mode

This feature places the console in Unattended mode. It should only be used when multiple attendant consoles are sharing the load of incoming calls.

When one console is in Position Busy Mode, new calls are sent to other console(s). Held and unanswered transferred calls will continue to recall to the console that processed them. When the last console in the Attendant group is placed in Position Busy mode, the entire group is considered Unattended. Consoles must set Call Forward and/or Night Transfer in order for calls to be rerouted to another destination, such as Night Bell, alternate answer position, etc.

Release Button

This button releases the console from any connection by transferring (or extending) the call and placing the console in the idle state.

Speed Dial Calling

Speed dial numbers and names can be used for calling or transferring. When a speed dial name or location number is entered on the “active keyboard,” speed dial information displays. Up to 40 station speed dial numbers and 100 system speed dial numbers (for RCTUB, RCTUC/D), or 800 system speed dial numbers for RCTUE/F can be stored in the speed dial list.

From the console, the Attendant enters the names for the speed dial numbers; these names can be different from those entered in the system records, so the Attendant can customize them.

Split/Switch Button

The **Split/Switch** button is used to alternate between source and destination parties; the two parties are kept separate. This feature can only be used during a three-way conference (console, source and destination party). The parties can be connected on outside lines only, either on [DN] lines only, or on a combination of outside and [DN] lines. The Split feature does not work on four-party conference calls.

Three-way Calling

Three-way Calling enables an Attendant to talk simultaneously with the source and destination parties. This feature requires a connection with a station user or outside caller, including a party on Consultation Hold.

Through Dialing

This feature lets an Attendant provide outgoing call privileges to a restricted station user. On a call-by-call basis, the Attendant can access otherwise denied trunks and then pass the dial tone to the station user. The station user can then complete the call dialing procedure. Through Dialing can also be applied to callers using DISA and incoming Tie trunks.

Transfer Direct to Voice Mail

A button on the DK PC-ATT enables direct transfer of outside callers to a station user's voice mailbox. This is more efficient than directing a call to a busy station which, if call forward was set to voice mail, would then forward. This is also helpful when the Attendant knows a station user is unavailable. This feature is also useful the called party does not own a station set, but they do have a voice mailbox. The Attendant can release the call when voice mail answers.

Trunk Group Busy Indication

This feature shows the trunk groups and whether all members of the group are busy. Trunk groups with no members are always shown busy.

Trunk Group Control

Outgoing CO line groups can be restricted on an as-needed basis. This feature also restricts outgoing calls on two-way CO line groups. This enables the Attendant to control outgoing traffic on heavily-used line groups during busy hours.

Volume Control

The **Vol Up** and **Vol Dn** buttons adjust the console's ringing and handset/headset volumes.

Windows PC Operation

The Strata DK PC-ATT software runs on the computer as an application within Windows. Toshiba recommends using a dedicated PC for the console; however, other applications can run simultaneously on the same PC. The PC can toggle between Attendant Console mode and other applications.

The console commands are similar to other Windows applications, making training easier for previous Windows users. Either a mouse or keyboard can be used for console operation.

Table 36 PC Attendant Console Feature List

Attendant Console Features	
Answer Button	Incoming Call Identification
Answer Priority	Incoming Call Statistics
Answer Prompting by CO Line or DNIS	Interposition Call Transfer
Attendant Conference Setup	Join Button
Auto Day/Night Mode Switching	Keyboard or Mouse Operation
Auto Dialing	Load Sharing
Busy Lamp Field (BLF) Display	Loop Hold Display
Call Waiting Count	Message Center
Color CRT Display	Multi-tasking
Dial "0" For Attendant	Name/Number Dialing
Dial Outside Number for Station User	Overflow
Direct Station Selection (DSS)	Override
Directory Display and Dialing Internal [DN]	Position Busy Mode
DTMF Signaling from Dial Pad (Tone Button)	Release Button
Emergency Calls	Speed Dial Calling - Outgoing Speed Dialing
Emergency Page	Split/Switch Button
Feature On-Line Help	Three-way Calling
Feature Prompting with Soft Keys	Through Dialing
Flexible Programmable Buttons	Transfer Direct to Voice Mailbox
Headset Operation ¹	Trunk Group Busy Indication
Hold Button	Trunk Group Control
Hold Timer Display	Volume Control
	Windows PC Operation
Station Features Performed by the Attendant Console	
Account Code Calls	Conferencing
Alarm Set	Dialed Number Identification Service (DNIS) Display
ANI/Caller ID Display ¹	Directory Number User Name/Number Display
Automatic Callback	DISA Security Code Revision
Automatic Hold	Door Lock Control
Automatic Recall	Door Phone Operation
Parked Calls	DTMF Tone Signaling from Dial pad
Held Calls	Last Number Redial
Transferred Calls	Message Waiting
Background Music Control	Night Transfer
Call Forward	Paging
Call Park	♦ External Speakers ¹
♦ Call Park Orbits	♦ Telephone Speakers
♦ Auto Park/Page	Privacy Release
♦ Call Pickup	Saved Number Redial
Call Transfer with Camp-On	User Programmable Feature Buttons

1. Some feature implementation may require additional auxiliary equipment.

Appendix

This appendix contains reference information for the DK14, DK40i and DK424 systems and compatible stations. The information here applies to all systems unless noted otherwise.

The tables in this appendix include:

- ♦ [Network Requirements](#)
- ♦ [Customer-supplied Peripherals and Interfaces](#)
- ♦ [Station Specifications](#), which includes these tables:
 - ♦ [Station Loop Requirements](#)
 - ♦ [Station Dimensions](#)
 - ♦ [System Tones](#)
 - ♦ [Subassemblies for Toshiba Telephones](#)
 - ♦ [Data Interface Specifications](#)

Network Requirements

Table 37 PCB Network Requirements

PCB/Interface	Facility Interface Code	Network Jack	Ringer Equivalence	Universal Service Order Code
QSTU2/PESU/RSTU2/ KSTU2/RDSU ¹ (Off-premises Station)	OL13A (PESU) OL13B (QSTU2, RSTU2, -24V) OL13C (RSTU2, RDSU with R48S-48V)	RJ21X	N/A	9.0F
QCDU2/RCOU/RCOS, TCOU (loop start line)	02LS2	RJ11C/RJ21X (QCDU2 only) RJ14C/RJ21X (all others)	0.3B	N/A
RDDU, TDDU	02RV2-T	RJ14C/RJ21X	0.0B	AS.2
REMU type 1 or type 2	TL11M, 2-wire TL31M, 4-wire TL12M, type 2, 2-wire TL32M, type 2, 4-wire	RJ2EX RJ2GX RJ2FX RJ2HX	Not Available (N/A)	9.0F
RGLU2 (ground or loop start line)	02GS2 (ground) 02LS2 (loop)	RJ14C/RJ1CX	0.3B	N/A
RDTU (DS-1/T1) ²	(See last bullet note on Note 2 below.)	RJ48C/RJ48X/ RJ48M	N/A	6.0P
RCIU2/RCIS (Caller ID)	N/A	RJ21X/RJ14C	0.3B	N/A
RPTU (PRI) ³	04DU9-1SN	RJ48C/RJ48M	N/A	6.0P
RBSU (S/T, BRI) ³	02IS5	RJ48C/RJ48X	N/A	
RBUU/RBUS (U, BRI) ³	02IS5	RJ48C/RJ48X	N/A	
RCMU/RCMS (CAMA)	02RV2-O	RJ11C/RJ21-X	N/A	
TBSU	02IS5	RJ48C/RJ48X	N/A	6.0P

- Only PESU circuits 1 and 2, and RDSU circuits 1~4 provide Off-premises Station (OPS) capability. PESU must use OL13A or equivalent line conditioning for OPS connection. RDSU must use OL13A or OL13B if providing -24 volt loop voltage. If equipped with the -48 volt loop option PCB (R48S), OL13A, OL13B, or OL13C may be used for OPS connection.
- When ordering DS-1/T1 circuits, six items must be specified:
 - The number of channels per T1 circuit, fractional increments are normally 8, 12, or 16 channels, full service is 24 channels. Unused channels must be bit-stuffed.
 - Type of CO line assigned to each channel: Loop Start, Ground Start, Tie (Wink or Immediate Start), DID (Wink or Immediate).
 - Frame Format Type: Super Frame (SF) or Extended Super Frame (ESF). The T1 provider normally specifies the Frame Format to be used, either is adequate for DK424 CO digital voice lines. ESF provides a higher level of performance monitoring, but requires trained personnel and the ESF CSU normally costs more than an SF only CSU.
 - Line Code Type: Alternate Mark Inversion (AMI) or Bipolar 8 Zero Substitution (B8ZS). The T1 provider normally specified the Line Code to be used, either is adequate for DK424 T1 CO digital voice lines.
 - The customer may have to provide the Channel Service Unit (CSU) to interface the DK424 T1 circuit to the Telco T1 circuit. (CSUs are a Telco requirement.)
 - RDTU Network Channel Interface Codes: 04DU9-BN, 04DU9-DNZZ, 04DU9-1SN, 04DU9-1KN, 04DU9-1ZN.
- For information on how to order ISDN PRI/BRI circuits, you should refer to the Toshiba ISDN Training CBT. ISDN circuits may require a customer-provided CSU for PRI and/or Terminal Adapter or Network Terminal units for BRI. In U.S. CSU/TAs must be UL-listed in the U.S. In Canada, they must be CSA certified.

Customer-supplied Peripherals and Interfaces

The Strata DK supports many customer-supplied peripheral devices, a number of which are listed in [Table 38](#) (with the supporting PCB or data interface unit noted). For a depiction of these devices, see [Figure 16 on Page 52](#).

Table 38 Customer-supplied Peripherals and Interfaces

Peripheral	Interface
Auto Attendant (built-in) digital announcement devices	QSTU2, KSTU, RSTU2, RDSU, or PESU
Alternate BGM interface	QRCU3, QSTU2, KSTU2, RSTU2, RDSU, PEKU, or PESU
Caller ID	KSTU2, WSIU, TCIU2, TCOU, RSIU, RCIU/RCIS, RGLU, RCOU, RCOS, PIOU
Dictation equipment	QSTU2, RSTU2, RDSU, or PESU
DTMF	An optional QRCU3, K5RCU, K5RCU2 or RRCS tone receiver is required if a DTMF signalling peripheral is connected to QSTU2, KSTU2, RSTU2, RDSU, or PESU; or if Tie, DID or DISA lines are used.
External page equipment	PIOU, PIOUS, PEPU, DK14 KSU or DK40i Base KSU
External remote maintenance modem	WSIU, TSIU, PIOU, PIOUS, RSSU or RSIU
Fax machines	QSTU2, RSTU2, RDSU, or PESU
Local maintenance terminal	WSIU, TSIU, PIOU, PIOUS, RSSU, or RSIU
Mainframe computers	PDIU-DS
Modems	WSIU, TSIU, RSTU2, RDSU, KSTU2, QSTU2, PESU, or PDIU-DS
Personal computers	RPCI or PDIU-DS
Radio paging equipment	QSTU, KSTU, RSTU2, RDSU, or PESU
Remote maintenance (built-in)	RSIU with RMDS, PIOU or PIOUS with IMDU
Standard telephones	QSTU2, KSTU2, RSTU2, RDSU, or PESU
Standard telephone with Message Waiting neon lamp	RSTU2
SMDR printer/call accounting device or SMDI	WSIU, TSIU, PIOU, PIOUS, RSIU, RSIS
Voice mail device voice ports	QSTU2, KSTU2, RSTU2, RDSU, PESU or Strategy DK
ISDN Terminal Adaptors/ Terminal Equipment ¹	RBSU/RBSS, RBUU/RBUS

1. ISDN Terminal Adaptors (TA) and Terminal Equipment (TE-1) are ISDN status devices, such as ISDN telephones, G-4 fax machines, modem and video conference interfaces, etc.

Station Specifications

Table 39 Station Loop Requirements

Device	No. of Wire Pairs (24 AWG twisted pair)	Max. Loop Resistance (includes device)	Max. Distance (KSU/Cabinet to Device)
Digital telephones ¹ DDSS consoles PDIU-DS DDCB	1-pair	40 ohms	1000 ft. (303 m)
Attendant Console (DK424 only)	2-pair		
HDCB			
Electronic telephones	2-pair; 3-pair for OCA		
RPCI-DI or PDIU-DI2	Shares digital telephone wire-pair ¹		
DADM			
RATI (DK424 only)	1- or 2-pair		
HDSS consoles	2-pair	20 ohms	500 ft. (152 m)
Standard telephones, voice mail, AA, etc.	1-pair	300 ohms	Approx. 3000 ft. (909 m) with 150 ohm device. ²
		600 ohms	Approx. 9000 ft. (2727 m) with 150 ohm device. ²
		1,200 ohms	Approx. 21000 ft. (6363 m) with 150 ohm device. ²
BRI-TE1 (S or U type) ³	4-pair modular	100 ohms	1650 ft.
BRI-TA (S or U type) ³			1650 ft.

- Two-pair wiring or optional telephone power supply is required to achieve maximum range with DADM, OCA, Headset, or DIU.
- See manufacturer's product specifications for exact resistance of device.
- ISDN station devices (telephones, fax machines, modems, etc.) are classified as Terminal Equipment (TE-1) or Terminal Adapters (TAs). There are generally two models available for each particular device: S-type or U-type.

Table 40 Station Dimensions

Device	Height	Width	Depth
10-button Digital Telephone with Handsfree Answerback (DKT2010-H)	3.3 inches (85 mm) ¹	7.8 inches (199 mm)	9.0 inches (230 mm)
10-button Digital Telephone with Speakerphone and Liquid Crystal Display (DKT2010-SD)	3.8 inches (97 mm) ¹	7.8 inches (199 mm)	9.0 inches (230 mm)
20-button Digital Telephone with Speakerphone (DKT2020-S)	3.3 inches (85 mm) ¹	7.8 inches (199 mm)	9.0 inches (230 mm)
20-button Digital Telephone with Speakerphone and Liquid Crystal Display (DKT2020-SD)	3.8 inches (97 mm)	7.8 inches (199 mm)	9.0 inches (230 mm)
Digital Single Line Telephone (DKT2001)	3.8 inches (97 mm) ¹	5.4 inches (137 mm)	9.0 inches (230 mm)
Add-on Module (DADM)	3.3 inches (85 mm)	2.8 inches (71 mm)	9.0 inches (229 mm)
Direct Station Selection (DSS) Console	3.3 inches (85 mm)	7.8 inches (199 mm)	9.0 inches (230 mm)
Stand-alone Data Interface Unit (PDIU-DS)	1.5 inches (38 mm)	4.8 inches (122 mm)	7.3 inches (185 mm)
External Speaker Amplifier (HESB)	10.3 inches (263 mm)	10.3 inches (263 mm)	5.0 inches (128 mm)
Door Phone/Lock Control Unit (DDCB)	4.6 inches (117 mm)	5.5 inches (140 mm)	1.5 inches (38 mm)
Door Phone (MDFB)	5.5 inches (140 mm)	3.1 inches (79 mm)	1.3 inches (33 mm)
Attendant Console Interface (RATI) (DK424 only)	1.5 inches (38 mm)	4.8 inches (122 mm)	7.3 inches (185 mm)
Handset with Handset Cradle (RATHC) (DK424 only)	2.8 inches (70 mm)	2.8 inches (70 mm)	9.5 inches (241 mm)
Strata AirLink Wireless Telephone Handset	6.0 inches (152 mm)	2.3 inches (58 mm)	1.0 inches (25 mm)
Digital Cordless Telephone (DKT2004-CT)	Height	Width	Depth
Base (without antenna)	3.7 inches (95 mm)	5.0 inches (128 mm)	7.5 inches (190 mm)
Handset (with antenna)	1.1 inches (27 mm)	2.2 inches (55 mm)	8.3 inches (210 mm)
Base with handset (with antennas)	8.7 inches (221 mm)	5.4 inches (137 mm)	8.8 inches (223 mm)

1. 4.1 inches (105 mm) with handset.

Table 41 System Tones

CO Line					
Idle digital and electronic telephones	Ring Tone Options	1	2	3	All tones are interrupted at 10 Hz 1-sec. ON – 3 sec. OFF
	Direct Ring Call	500/640 Hz	1200/1500 Hz	800/1000 Hz	
	Ring Transfer Call	540/760 Hz	1300/1780 Hz	860/1180 Hz	
Busy station (queuing) to DKT/EKT		2400 Hz, interrupted at 10 Hz, 1 sec. ON – 3 sec. OFF (twice or continuous 4 sec. apart)			
Busy station transfer (camp-on) to DKT/EKT		2400 Hz, interrupted at 10 Hz, one-time 1 sec. tone burst (twice or continuous 4 sec. apart)			
Standard telephone or voice mail port		20 Hz			
Normal ring option		1 sec. ON – 3 sec. OFF			
Camp-on tone options to standard telephone		No tone or two 160 msec. bursts of 1209 Hz 160 msec. apart, twice, 3 sec. apart			
Distinctive ring option (standard telephone)		0.4 sec. ON – 0.2 sec. OFF – 0.4 sec. ON – 3 sec. OFF			
Tie or DISA line calls					
To busy station		480/620 Hz, 0.50 sec. ON – 0.50 sec. OFF			
Internal [DN] Calls (except for DKT-2004-CT)					
Tone first (EKT/DKT ring signal)		500 Hz, 1 sec. ON – 3 sec. OFF (twice or continuous)			
Door phone	A & C	870 Hz, 1 sec./710 Hz, 0.5 sec. twice per ring (1 or 5 rings)			
	B	870 Hz, 0.5 sec./710 Hz, 0.5 sec. twice per ring (1 or 5 rings)			
Alert Signal to idle telephone		Six - 160 msec. burst of 350/440 Hz, twice 1 sec. apart			
Alert Signal to busy telephone		2400 Hz, interrupted at 10 Hz, 1 sec. ON, twice, 1 sec. apart			
Busy station transfer (camp-on) to DKT/EKT		2400 Hz, interrupted at 10 Hz, one-time 1 sec. tone burst (twice or continuous 3 sec. apart)			
Busy Override/DND Override		2400 Hz, 1 sec. ON – 3 sec. OFF (twice or continuous 3 sec. apart)			
Dial Tone (internal)		350/440 Hz, continuous			
Ringback Tone		440/480 Hz, 1 sec. ON – 3 sec. OFF (once: voice first; continuous: ring first)			
Busy Tone		480/620 Hz, 0.5 sec. ON – 0.5 sec. OFF			
Reorder Tone		480/620 Hz, 0.25 sec. ON – 0.25 sec. OFF			
Do Not Disturb		480/620 Hz, 0.125 sec. ON – 0.125 sec. OFF			
Voice Page Warning		500 Hz, 1 sec. ON (via DKT/EKT telephone speaker)			
Speaker OCA Warning		500 Hz, 1 sec. ON only (via DKT/EKT telephone speaker)			
Handset OCA Warning		350/440 Hz, 0.5 sec. (via DKT handset)			
Executive/Privacy Override Warning		440 Hz, 1 sec. ON only (via handset or speaker)			
Hold Recall		2400 Hz, interrupted at 10 Hz, 1 sec. ON – 1 sec. OFF			
Standard telephone ringing		20 Hz, 1 sec. ON – 3 sec. OFF			
Standard telephone Busy Override		160 msec. burst of 1209 Hz, twice, 3 sec. apart			
Standard telephone Camp-on tone		Two 160 msec. bursts of 1209 Hz, 160 msec. apart, twice, 3 sec. apart			
Voice Mail Special Tones					
Answer:	DTMF "A"	80 or 160 msec., dual tone			
Disconnect:	DTMF "D"				
Recall:	DTMF "B"				
Special Confirmation Tones					
Verified Account Code confirmation tones (sent only to the station that enters the code, not to the outside party)	Code valid	350/440 Hz, 0.5 sec. ON			
	Code not valid	350/440 Hz, 0.125 sec. ON – 0.125 sec. OFF – 0.125 sec. ON			
Station option programming confirmation tones (Call Forward, Timed Reminders, etc.)		350/440 Hz, 1 sec. ON			
ACD					
Supervisor Monitoring Tone		350/440 Hz, 0.5 sec. every 15 sec.			
Queue Alarms	Alarm 1	2400 Hz, interrupted at 10 Hz, 1 sec. ON – 0.5 sec. OFF			
	Alarm 2	2400 Hz, interrupted at 10 Hz, continuous			

Table 42 Subassemblies for Toshiba Telephones

Subassembly	Host Telephone	Function	Capacity per Telephone
DVSU ¹	2000- and 1000-series Digital Telephones	Provides interface for digital telephone to receive Speaker OCA. Not required for Handset/Headset OCA.	1
RPCI-DI ¹	2000-series Digital Telephones	Provides two modes of operation: TAPI PC application interface and Data Calling interface.	
HVSU2	6500-series Electronic Telephone	Provides interface for electronic telephone to receive OCA.	
HHEU	2000- and 1000-series Digital Telephones. 6500- and 6005-series Electronic Telephones	Provides interface for headset and Loud Ringing Bell to telephone. Can be installed with DVSU, RPCI-DI, or DADM.	
DADM ¹	2000-series Digital Telephones	Provides telephone with 20 (or 40 with two DADMs) additional feature buttons for DSS, System or Station Speed Dial, or CO line appearances.	1 or 2

1. Only one of the following subassembly types is allowed per telephone: DVSU, RPCI-DI or DADM.

Table 43 Data Interface Specifications

Item	Specifications
Terminal or personal computer interface specification	RS-232C (EIA) V.24/V.28 (CCITT) TAPI compatible (RPCI-DI only)
Data transmission speed	Up to 19.2 kbps, asynchronous
Flow control	Half and full duplex, utilizing RTS/CTS/CD control leads
Automatic dialing	Based on AT commands: <ul style="list-style-type: none"> ◆ Data speed of AT command is 300, 600, 2300, 2400, 4800, or 9600 ◆ Data bit: 7 or 8 bits ◆ Stop bit: 1 or 2 bits ◆ Parity bit: even, odd, or no parity
Maximum distance: KSU to DKT with integrated RPCI-DI or stand-alone DIU	<ul style="list-style-type: none"> ◆ With system power supply; 1000 feet with 2-pair (24 AWG) ◆ With battery back-up; 330 feet with 1-pair or 675 feet with 2-pair (24 AWG), or 1000 feet with external power to telephone
Number of wire pairs	1-pair or 2-pair (24 AWG)
LED indicators (stand-alone DIU only)	Power: lights when power is on Ready: lights when DTE and DIU are ready Connect: lights when DIU is in transmission or ringing mode
Automatic disconnect time-out	Forced hang up when RPCI-DI or PDIU does not detect data on SD or RD within nine minutes.
LSI technology (RPCI-D1/PDIU-DS only)	<ul style="list-style-type: none"> ◆ One-chip CPU with a clock frequency of 12.288 MHz ◆ Memory: ROM, 16KB; RAM, 512KB ◆ Ping-pong transmission: LSI with bearer transmission rate of 512kbps, 2B+D-type link
Strata DK option compatibility	Digital telephones with integrated RPCI-DI: <ul style="list-style-type: none"> ◆ No DVSU (Speaker Off-hook Call Announce only) ◆ No Add-on Module ◆ Compatible with associated DDSS console ◆ Compatible with headset (HHEU) ◆ Desktop or wall mount compatible
Cabling/connectors	<ul style="list-style-type: none"> ◆ RPCI-DI, PDIU-DS to DTE/DCE device: 9-wires, 50 feet maximum, 24AWG: compatible with RJ-45, 8-wire modular cable and RJ-45 to DB25 RS-232 modular adaptors ◆ Stand-alone DIU: RJ-11 modular connector ◆ Integrated RPCI-DI: connected inside digital telephone ◆ Stand-alone DIU jumper plugs enable straight wire connection to a DTE or DCE device without null-modem cables or adaptors

Glossary

Term	Definition
AA	Auto Attendant (built-in or external). This feature acts as an automatic operator that directs incoming callers to stations by offering a menu of dialing prompts.
ABR	Automatic Busy Redial.
ACB	Automatic Callback.
ACD	Automatic Call Distribution. Allows incoming calls to be distributed to a group of ACD agents. The ACD Supervisor's LCD telephone displays ACD Agent and Group information which allows the Supervisor to monitor calls and assist agents.
ADM	Add-on Module— <i>See DADM.</i>
AMI	Alternate Mark Inversion.
ANI	Automatic Number Identification—Telephone number of the calling party is sent to the Strata DK system over incoming DID or Tie lines. This feature is provided by some long distance telephone service companies.
B-channel	Used in ISDN. Data or voice information is transmitted on the B-channels of an ISDN line at 64kpbs. The B-channel refers to the frequency range of transmissions on a copper pair; it is a logical, rather than physical channel. Also see BRI and PRI.
B8ZS	Bipolar 8 Zero Substitution.
BGM	Background Music—Allows customer-supplied music to be sent to telephone speakers and external speakers.
BLF	Busy Lamp Field.
BPS	Bits Per Second—Unit of measure that refers to the transmission speed (baud rate) of electronic signals. It is used when describing the Data Interface Unit and modem operation.
BRI	Basic Rate Interface—ISDN line with 2B + 1D channel. BRI lines can have a U-interface with RJ-11 jacks and single twisted pair wiring, or RJ-45 four pair S/T interface wiring. BRI is the smaller ISDN interface than PRI.
BSIA	Base Station Interface Adapter—Interface between the Strata Airlink™ Wireless Telephone Base Stations and the host telephone system.
CESID	Caller's Emergency Service Identification—Telephone number for specific station or station location which is sent to the CAMA trunk.
CLASS	Custom Local Area Signaling Services—Defines a number of features offered by local telephone companies.
CLID or CND	Calling Line Identification or Calling Number Delivery—Telephone number or name of the calling party sent to the Strata DK system over incoming ground or loop start CO lines. This feature is one of the "CLASS" features offered by some local telephone companies.

Term	Definition
CO	Central Office—The facility which houses switching equipment that provides telephone service (CO lines, E & M Tie lines, DID lines, Centrex lines, etc.) for the immediate geographical area.
CODECs	Coder/Decoder—Semiconductors that allow the system to process analog-to-digital and digital-to-analog conversions.
CSU	Channel Service Unit. Required between the DK PRI interface and the PRI line provider interface in most locations of the U.S.
CNIS	Calling Number Identification Services—Caller ID for ISDN. CNIS is calling party information for outgoing and incoming calls sent to the ISDN network.
DADM	Digital Add-on-Module—Optional device that connects to 2000-series digital telephones to provide the telephones with 20 flexible feature buttons that can be assigned individually for Direct Station Selection, System and Personal Speed Dial, and CO line access.
D-channel	Used in ISDN. This channel transmit call control information (out-of-band signaling) for B-channels. The D-channel is a logical, not physical channel.
DDCB	Digital Door Phone/Lock Control Unit—A peripheral hardware unit compatible with designated digital telephone circuits that supports optional door phones (MDFBs) and provides door lock control.
DDSS	Digital Direct Station Selection Console—A device that helps facilitate the processing of a heavy load of incoming calls. The DDSS connects only to designated digital telephone circuits, and is associated with a digital telephone.
DH	Distributed Hunt.
DID Line	Direct Inward Dialing line—Allows external callers to dial directly to an internal number.
DIL	Direct In Line—Refers to two-way, standard CO trunk lines that are assigned to a particular extension or hunt group.
DISA	Direct Inward System Access—Enables an outside party to access the Strata DK system internal stations or outgoing CO lines without having to go through an operator or automated attendant. An optional security code may be set to prevent unauthorized access to outgoing CO lines for through system calling.
DKT	Digital Key Telephone.
[DN]	Directory Number.
DNIS	Dialed Number Identification Service—Telephone number of called party is sent to the Strata DK over incoming DID or Tie lines. This feature is provided by some long distance telephone companies.
DSS	Direct Station Selection—Enables a telephone user (as well as a DSS console and ADM user) to call another station with the touch of a flexible feature button.
DTMF	Dual-tone Multi-frequency—Push-button tone dialing.
DVSU	A subassembly that equips a digital telephone with the capability to receive Speaker Off-hook Call Announce (OCA) calls. DVSU is not required to receive Handset OCA (HS-OCA).
EKT	Electronic Key Telephone.
ESF	Extended Super Frame.
FIFO	First-In, First-Out.
HDCB	Electronic Door Phone/Lock Control Unit—A peripheral hardware unit compatible with designated electronic telephone circuits that supports optional door phones (MDFBs) and provides door lock control.

Term	Definition
HDSS	Electronic Direct Station Selection Console—A device that helps facilitate the processing of a heavy load of incoming calls. The HDSS console connects only to designated electronic telephone circuits, and is associated with electronic telephones.
HESB	External Speaker Box—A speaker/amplifier that can be configured with the system to provide a variety of functions, such as a paging speaker and/or Background Music (BGM) speaker.
HHEU	Headset/Loud Ringing Bell Interface—Subassembly that fits inside a digital telephone or a 6500-series electronic telephone to allow a headset or an external speaker box (HESB) to be connected to the telephone.
ISDN	Integrated Services Digital Network. ISDN service requires service subscription from a telco with ISDN equipment. It allows digital information to be exchanged directly at each end of the line, without the need to convert analog to digital signals. Connection speeds are faster and audio quality is superior.
LATA	Local Access and Transport Area.
LCD	Liquid Crystal Display—The optional display on digital and electronic telephones that displays calling information.
LCR	Least Cost Routing.
LSI	Large Scale Integration—Related to circuit design technology. Strata DK system printed circuit boards (PCBs) use LSI circuit design.
MDF	Main Distribution Frame—The wiring frame usually located in a phone closet.
MDFB	Door Phone Box—A peripheral two-way speaker box option.
MOH	Music-on-Hold—Customer-supplied music or announcements can be sent to parties on-hold on CO lines or the intercom.
NFAS	Non-facility Associated Signaling—provides the ability to create ISDN trunk groups beyond the 23 channels available with a single Primary Rate Interface.
NT-1	Used in ISDN. Network Termination device that powers a U-interface ISDN line and enables multiple S/T ISDN devices to connect to it. The NT-1 must be UL-listed (U.S.) or CSA-certified (Canada).
OCA	Off-hook Call Announce. There are two types: Handset OCA and Speaker OCA.
PBX	Private Branch Exchange—Industry-standard term which refers to a telephone switch, usually on-premises, which serves an individual company, and is connected to a public telephone exchange through the Central Office (CO).
PCB	Printed Circuit Board.
[PDN]	Primary Directory Number.
PF	Power Failure.
[PhDN]	Phantom Directory Number.
PRI	Primary Rate Interface—A trunk interface to the ISDN network, which enables multiple use of channels for DID, Tie, FX, WATS, 800, etc. It supports multiple services and dynamic channel allocation. PRI is the larger ISDN interface (via the RPTU) with 23B+D transmission format. Channels are 64-kbps. Also see BRI.
PSAP	Public Safety Answering Point—Used for E911 calls.
RAM	Random Access Memory—Refers to the type of system memory that holds individual system configuration and feature programming. RAM is read/write memory, and can be easily revised in programming.

Term	Definition
ROM	Read Only Memory—Refers to the type of system memory that holds static software that comprises the mechanics of the features' functions. ROM is only revised by Toshiba software engineers.
[SDN]	Secondary Directory Number.
SF	Super Frame.
SLT	Single-line Telephone.
SMDI	Simplified Message Desk Interface—RS-232 link from PIOU, PIOUS, RSSU, RSIS, or RSIU modular jack connected to a voice mail machine to provide Strata DK voice mail integration.
SMDR	Station Message Detail Reporting.
SMIS	Software Management Information System (SMIS).
S/T Interface	Reference interface points ("S" or "T") of an ISDN network. S/T interfaces are RJ-45, 8-wire connection interfaces for ISDN equipment. An NT-1 is needed to network U-type BRI lines to S/T type interfaces.
TAPI	Telephone Application Programming Interface.
TA	Terminal Adapter or ISDN modem that converts PC and other types of protocol into a signal that works with ISDN. Generally, TAs support RJ-11 voice ports and RS-232C or V.35 or V.449 data interfaces.
TE	Terminal Equipment. This refers to devices using ISDN service (telephones, faxes, computers, etc.). TE1 supports ISDN formats with S/T or U-type interfaces.
TSPI	Telephony Service Provider Interface.
U Interface	A single twisted pair of copper wire on an RJ-11 jack. The wiring is identical to POTS, with different signaling. Only one U-interface device can be attached per line.

Index

Symbols

[DN], 95
[PDN], 77, 88
[PhDN], 77
[SDN], 77

Numerics

48v loop voltage, 37

A

AA, 12, 62
abandoned call numbers, 61
ABR, 90
ACB, 90
account code button, 90
account codes, 61
ACD, 62
add-on modules, 90
 capacities, 89
administration software, 83
alarm sensor, 62
alert signal button, 90, 100
alternate answer point, 62
amplified conference, 88
 interface, 62
ANI, 63, 88
ANI/caller ID, 100
answer
 button, 102
 priority, 102
 prompting, 102
attendant console (see PC attendant console)
auto attendant, 62
 DK14 feature key, 4
 DK40i feature key, 12
 DK424 feature key, 21
 simultaneous announcements, 88
auto day/night mode switching, 102
auto dialing, 102

automatic

busy redial, 90
call distribution, 62
callback, 90
hold, 90
line selection, 91
number identification, 63
release from hold, 64

B

background music, 64
 with station control, 91
base cabinet, 19
basic rate interface (see BRI, see also ISDN)
BGM, 64, 91
BRI, 39, 40, 40, 73
busy lamp field display, 102
busy override, 91
busy station transfer/busy station ringing, 91

C

cabling, 60
call forwarding
 all calls, 91
 busy, 92
 busy/no answer, 92
 external call, 92
 fixed, 92
 no answer, 92
call park orbits, 88
 auto park, 93
 park and page, 92
call pickup, 93, 100
call transfer
 immediate, 93
 recall, 94
 unrestricted to DNS, 85
 with camp-on, 93
call waiting count, 103

- caller ID, 12, 65, 88
 - interface unit, 37
 - lines (see also BRI, PRI lines)
 - calling number identification services, 75
 - CAMA trunk, 40
 - centrex ringing repeat, 65
 - centrex/PBX
 - compatible, 65
 - features, 94
 - CNIS, 75
 - abandoned call numbers, 88
 - CO line, 9
 - capacities, 89
 - groups, 88
 - CO line/digital telephone interface, 36
 - CO private lines, 98
 - color CRT display, 103
 - common control units, 20
 - computer telephony integration (CTI), 66
 - conferencing, 67, 88, 94
 - connectors, 60
 - continuous DTMF tone, 94
 - cordless digital telephone, 54, 89, 100
 - credit card calling, 67
- D**
- DADM, 53, 90
 - data call button, 94
 - data switching, 67
 - day/night modes, 67
 - DDCB, 59
 - DDSS, 58, 94
 - delayed ringing, 67
 - DH, 82, 88
 - diagnostics and troubleshooting
 - system, 18, 33
 - dial “o” for attendant, 103
 - dial outside number for station user, 103
 - dialed number identification service, 68
 - DID, 38, 68
 - lines, 89
 - digital
 - add-on module, 53
 - single line telephone (see DKT2001)
 - telephones, 48
 - features, 90, 100
 - interface unit, 35
 - system capacities, 89
 - upgrade options, 53
 - digital/standard telephone interface unit, 35
 - direct inward dialing
 - interface unit, 38
 - lines, 68
 - direct inward system access, 69
 - direct station selection, 103
 - button, 94
 - console, 58, 94
 - directory
 - display and dialing, 103
 - number buttons, 95
 - DISA, 69
 - security code revision, 95
 - distinctive
 - CO line/directory number ringing, 69
 - LED color indications, 95
 - station ringing, 95
 - distributed hunt, 82, 88
 - DK14, 1
 - base KSU architecture, 2
 - digital telephone circuits, 2
 - features, 61
 - functional block diagram, 6
 - maintenance and programming, 8
 - power failure interface, 4
 - power supply, 4
 - stations and peripherals, 47
 - system technology, 7
 - typical line configurations, 5
 - DK40i, 9
 - base KSU
 - architecture, 11
 - caller ID, 12
 - CO line circuits, 11
 - digital telephone circuits, 11
 - expansion KSU architecture, 14
 - features, 61
 - functional block diagram, 16
 - interface PCB options, 44
 - line configurations, 14
 - maintenance and programming, 17
 - power failure interface, 14
 - power supply, 13
 - stations and peripherals, 47
 - system technology, 17
 - DK424, 19, 109
 - architecture, 19
 - features, 61
 - floor mount hardware, 28
 - functional block diagram, 29
 - interface PCB options, 45

- maintenance and programming, 32
 - maximum line capacities, 22
 - PCBsubassemblies, 21
 - peripherals, 52
 - power requirements, 26
 - printed circuit boards, 21
 - release 3.2, 101
 - release 4.0, 64, 68, 69, 73, 83, 84
 - stations and peripherals, 47
 - system technology, 32
- DKAdmin, 8, 17, 32, 83
- DK-PCATT, 57
- DKT2001, 49, 100
- DKT2004-CT, 54, 89
- DNIS, 68, 88
- do not disturb, 95
 - override, 95
- door locks, 89
- door phones, 59, 69, 89
 - lock control unit, 59
- DP/DTMF mode change, 95
- DSS, 94, 103
- DTMF
 - back tone, 70
 - dial pulse CO line compatible, 70
 - receiver subassembly, 21
 - signal time, 70
 - signaling from dial pad, 103
- DTMF/ABR tone detection receiver, 12
- DVSU, 54

E

- E&M tie line unit, 38
- E911 cama trunk
 - interface unit (RMCU), 40
 - subassembly (RCMS), 40
- E911 CAMA trunk, 40
- electronic telephone
 - features, 90, 100
 - interface unit, 36
 - system capacities, 89
- emergency
 - calls and paging, 103
 - enhanced 911 service, 70
- EOCU, 36
- exclusive hold, 95
- executive override, 96
- expansion
 - cabinets, 19
- expansion KSU, 14

- external
 - page interface unit, 44
 - page zones, 71
 - speaker (HESB), 59
 - telephone network numbers, 68
- external page zones, 88

F

- feature prompting with soft keys, 96
- features, 61
 - PC attendant console, 102
 - station, 90
 - system, 61
- flash button, 96
- flexible
 - button assignments, 71
 - directory numbers, 71
 - line ringing assignment, 71
 - programmable buttons, 104
 - relay contacts, 5
- functional block diagram, 6, 16, 29

G

- ground/loop start interface CO line interface unit, 38
- group paging, 71

H

- handset OCA stations, 89
- handsfree
 - answerback, 96
 - directory number paths, 72
- headset operation, 104
- headset/loud ringing bell interface, 53
- hearing aid compatible, 96
- HESB, 59
- HHEU, 53
- HMIS, 72
- hold
 - button, 104
 - timer display, 104
- hospitality management information system (see HMIS)

I

- incoming call
 - identification, 104
 - statistics, 104
- integrated PC Iinterface, 53
- integrated services digital network (see ISDN)
- interposition call transfer, 105

ISDN, 73
 basic rate interface unit (RBSU), 39, 40
 subassembly (RSSS), 39
 subassembly (RSSS), 40
 BRI S/T or S-type circuits (TBSU), 12
 BRI station circuits TE-1 and TA, 89
 BRI, PRI channel lines, 89
 primary rate interface unit (RPTU), 39

J

join button, 105

K

K5RCU3, 12
KCDU, 36
keyboard or mouse operation, 105
KKYS1, 12
KSTU2, 12

L

LCD
 features, 96
 telephones, 50
least cost routing, 75
line
 capacities, 5, 14, 22
 groups, 76
 queuing, 76
live system programming, 76
load sharing, 105
loop hold display, 105
loop start CO line interface, 38
 subassembly, 38

M

maintenance
 DK14, 8
 DK40i, 17
 DK424, 32
 DKAdmin/modem (TTY) interface, 12
MDFB, 59
memory protection, 76
message center, 105
message waiting, 78
 buttons, 78
microphone cut-off button, 96
modem button, 96
modular
 handset and line cords, 96
 headset, 97
MOH, 5, 78

multiple directory numbers
 PDN, SDN, PhDN, 77
multiple FCC registration, 78
multi-tasking, 105
music-on-hold, 78
 interface, 5

N

name/number dialing, 106
night ringing over
 external page, 78
 selected page zones, 78
non-blocking talk paths, 78
non-facility associated signaling (NFAS), 74

O

OCA speaker, 89
off-hook call announce, 89
 handset mode, 97
 speaker mode, 54, 97
 upgrade unit, 36
off-premises stations, 78, 89
on-hook dialing, 97
option interface unit, 43
outgoing call restriction, 79
overflow calls, 106
overriding calls, 106

P

paging
 external zones, 88
 groups, 71, 88
 interface, 5
 max. simultaneous stations, 88

PC

 applications, 99
 attendant console, 57
 conference setup, 102
 features, 102
 interface unit, 37
 on-line help, 104
 soft keys, 104
 system capacities, 89
 digital telephone, 56
PCB, 21
 circuits, interface options and connectors, 40
 CO line, 37
 console, 37
 option interface, 43
 station, 35
 universal slot, 35

PC-DKT, 56
 PC-telephone interface (RPCI-DI), 98
 PDIU-DS, 54, 89
 PDKU2, 35
 PEKU, 36
 PEPU, 44
 peripherals, 52
 customer-supplied, 111
 specifications, 60
 PESU, 36
 PhDN, 77, 88
 PhDN/MW, 78
 pickup groups, 88
 PIOUS, 43
 pooled line button, 79, 98
 position busy mode, 106
 power failure transfer, 79
 PRI, 39, 73
 primary rate interface (see PRI, see also ISDN)
 privacy/non-privacy, 79
 programming
 DK14, 8
 DK40i, 17
 DK424, 32
 push-button dialing, 98

Q

QCDU2, 3
 QKYS1, 3
 QRCU3, 3
 QSTU2, 3

R

R48S, 37
 RATU, 37
 RBSU, 40
 RBUU, 41
 RCIS, 37
 RCIU2, 37
 RCMS, 40
 RCOS, 38
 RCOU, 38
 RDDU, 38
 RDSU, 35
 RDTU, 38
 RDTU2, 41
 relay service, 79
 external page/door lock control relay, 80
 night relay/hold relay, 80

release
 3.2, 94, 101
 4.0, 64, 68, 69, 73, 83, 84
 button, 98, 106
 release/answer button, 98
 remote
 administration/maintenance, 80
 retrieval of held/parked calls, 98
 REMU, 38
 repeat last number dialed, 98
 reserve power, 80
 DK14, 4
 RGLU2, 38
 ringing line preference, 98
 RMCU, 40, 41
 RPCI, 98
 RPCI-DI, 53, 89
 RPTU2, 40
 RRCS, 21
 RSIU, 46
 RSSU, 45
 RSTS, 35
 RSTU2, 36
 RWIU, 43

S

saved number redial, 98
 [SDN], 77
 serial hunting, 81
 serial interface unit, 46
 simplified message desk interface (see SMDI)
 single serial interface unit, 45
 SMDI, 80
 SMDR, 12
 speaker
 OCA stations, 89
 off-hook call announce, 54
 speakerphones, 51
 speed dial, 81
 buttons, 99
 from PC attendant console, 106
 system capacities, 88
 split/switch button, 107
 stand-alone data interface unit, 54
 standard telephone, 89
 features, 100
 interface units
 KSTU2, 12
 RSTU2, 36
 subassembly, 35

standard/electronic telephone interface unit, 36
station lines, 9
station message detail recording (see SMDR)
stations
 dimensions, 113
 features, 90, 100
 hunting, 81
 relocation, 82
 specifications, 60
status window, 18, 33
Strata AirLink
 cabling, 60
 interface unit, 43
 troubleshooting, 33
 wireless handset, 55
StrataControl, 82
Stratagy DK, 59
StrataLink, 66
system
 features, 61
 programming, 83
 technology, 7
 troubleshooting, 18, 33

T

T1/DS-1
 interface unit, 38
 lines, 89
tandem CO line connections, 83
TBSU, 12
TCIU2, 12
TE-1, 39
telephone application programming interface (TAPI), 66, 99
telephones
 DKT, 48, 89
 DKT2004-CT (cordless), 54
 EKT, 89
 features, 90, 100
 wireless handset, 55
tenants, 84, 88
three-way calling, 107
through dialing, 107
tie lines, 84, 89
timed reminders, 99
toll restriction, 84, 88
 override codes, 99
transfer direct to voice mail, 107
traveling class of service, 85
trunk group busy indication and control, 107

TSIU, 12
TSPI, 66

U

universal slots, 89
 PCBs, 35
user programmable feature buttons, 99

V

verified account codes, 88
voice first/tone signaling, 85
voice mail, 68
 integration, 85
 SMDI, 88
voice processing
 Stratagy DK, 59
volume control, 107

W

windows
 PC operation, 107
 compatibility, 99
wireless handset (see Strata Airlink)
WSIU1, 3

Strata[®] ***DK***

Digital Business Telephone Solutions

Feature Description Manual

DK 14

Software Release 3.1

DK 40i

Software Release 4.1

DK424

Software Releases 4.0, 4.1, 4.2

Strata DK

General End User Information

The Strata DK Digital Business Telephone System is registered in accordance with the provisions of Part 68 of the Federal Communications Commission's Rules and Regulations.

Important Notice – Music-On-Hold

In accordance with U.S. Copyright Law, a license may be required from the American Society of Composers, Authors and Publishers, or other similar organization, if radio or TV broadcasts are transmitted through the music-on-hold feature of this telecommunication system. Toshiba America Information Systems, Inc., hereby disclaims any liability arising out of the failure to obtain such a license.

Publication Information

Toshiba America Information Systems, Inc., Telecommunication Systems Division, reserves the right, without prior notice, to revise this information publication for any reason, including, but not limited to, utilization of new advances in the state of technical arts or to simply change the design of this document.

Further, Toshiba America Information Systems, Inc., Telecommunication Systems Division, also reserves the right, without prior notice, to make such changes in equipment design or components as engineering or manufacturing methods may warrant.

Version D, May 1999
Version C, November 1998
Version B, May 1998
Version A, March 1996

© Copyright 1999 Toshiba America Information Systems, Inc. Telecommunication Systems Division

All rights reserved. No part of this manual, covered by the copyrights hereon, may be reproduced in any form or by any means—graphic, electronic, or mechanical, including recording, taping, photocopying, or information retrieval systems—without express written permission of the publisher of this material.

Strata is a registered trademark of Toshiba Corporation. Strategy is a registered trademark of Toshiba America Information Systems, Inc. Strata AirLink, Call Center Viewer, Insight DK and Insight DK Plus are trademarks of Toshiba America Information Systems, Inc.

Trademarks, registered trademarks, and service marks are the property of their respective owners.

Contents

Introduction

Organization.....	vii
Conventions.....	viii
Related Documents	x

Chapter 1 – System Overview

Strata DK14.....	1
Strata DK40i.....	1
Strata DK424.....	1
Migration.....	2
System Capacities	2
Feature Availability.....	4
System Administration Tools.....	10

Chapter 2 – Features

System Features	15
Account Codes.....	16
Alarm Sensor	18
Alternate Answer Point	19
Amplified Conference	20
Auto Attendant	21
Automatic Hold Recall	23
Automatic Number Identification (ANI).....	24
Automatic Release From Hold	26
Background Music (BGM) Interface.....	27
Caller Identification (ID)	28
Centrex/PBX Compatibility	30
Centrex Ringing Repeat.....	31
Computer Telephony Integration (CTI)	32
Conferencing	35
Credit Card Calling (“0+” Dialing)	36
Delayed Ringing.....	37
Dialed Number Identification Service (DNIS)	38
Direct Inward Dialing (DID)	41
Direct Inward System Access (DISA)	42
Distinctive CO Line/Internal Ringing	43
Door Lock Control	44
Door Phone.....	45
DTMF and Dial Pulse CO Line Compatible	46

DTMF Signal Time Setting	47
E911 Enhanced Operation	48
External Amplified Speaker	50
Flexible Button Assignment	51
Flexible Intercom/DN Numbering.....	53
Flexible Line Ringing Assignment.....	54
Flexible Slot Assignment.....	55
Ground Start Lines	56
Hotline Service (Emergency Ringdown).....	57
ISDN Basic Rate Interface (BRI)	58
ISDN Primary Rate Interface (PRI).....	61
Least Cost Routing (LCR).....	64
Line Call Pickup Groups	65
Line Groups	66
Line Queuing	67
Live System Programming	68
Memory Protection	69
Message Waiting	70
Multiple Directory Numbers (DNs)	72
Multiple FCC Registration	74
Multiple Simultaneous Handsfree Intercom Paths	75
Music-on-Hold (MOH) Interface	76
Night Ringing Answer Code	77
Night Ringing Over External Page.....	78
Night Ringing Over Selected Page Zone.....	79
Night Transfer (Day/Night Modes).....	80
Non-blocking Dialing	81
Off-premises Station (OPS).....	82
Outgoing Call Restriction.....	83
Paging - All Call Voice Page.....	84
Paging - External Page Interface	85
Paging - External Zone Paging	86
Paging - Group Paging	87
Pooled CO Lines.....	88
Power Failure Transfer	89
Privacy/Non-privacy Option.....	90
Relay Service	91
Remote Administration/Maintenance	92
Reserve Power Battery Backup Interface.....	93
Speed Dial (SD).....	94
Station Hunting.....	96
Station Message Detail Recording (SMDR)	98
Station Relocation.....	101
System Programming Through Station	102
Tandem CO Line Connection (Trunk-to-Trunk)	103
Tenant Service	105
Tie Lines	106
Toll Restriction	107
Toll Restriction Override Codes.....	109
Toll Restriction Override Using System Speed Dial.....	110

Transfer Privacy	111
Traveling Class of Service.....	112
T1 Interface.....	113
Voice Mail Interface	114
Voice or Tone Signaling.....	117
Wall or Table Mounting	118
Station Features	119
Alert Signal Button.....	120
Automatic Busy Redial (ABR)	121
Automatic Callback (Internal Calls).....	122
Automatic Hold	123
Automatic Off-hook Line Selection	124
Background Music (BGM) with Station Control	125
Busy Override Tone.....	127
Busy Station Transfer/Busy Station Ringing.....	128
Call Forward	129
Call Park	132
Call Pickup	133
Call Pickup Groups.....	134
Call Transfer with Camp-on	135
Centrex/PBX Feature Buttons	136
Continuous DTMF Signal Time	137
Data Buttons	138
Direct Station Selection (DSS) Buttons.....	139
Distinctive LED Indicators	140
Distinctive Station Ringing	141
Do Not Disturb (DND)	142
Do Not Disturb (DND) Override.....	143
Dial Pulse/DTMF Mode Change.....	144
Exclusive Hold	145
Executive Override	146
Flash Button.....	147
Handsfree Answerback on Intercom	148
Hearing-aid Compatible	149
LCD - Alphanumeric Messaging.....	150
LCD - Automatic Callback Number Display	151
LCD - Busy Lamp Field Indication	152
LCD - Busy Station Messaging	153
LCD - Call Duration Display.....	154
LCD - Call Forward Source/Destination Display.....	155
LCD - Calling/Called Number Display	156
LCD - Called Station Messaging.....	157
LCD - Calling Station Messaging	158
LCD - Clock/Calendar Display	159
LCD - CO Line Identification	160
LCD - Dialed Number Display.....	161
LCD - Feature Prompting with Soft Key Operation.....	162
LCD - Message Waiting Display.....	163
LCD - Recalling Station Identification.....	164
LCD - Remote/Group Station Messaging	165

LCD - Speed Dial Memo Directory Dialing	166
LCD - Station Identification	167
LCD - Timed Reminders	168
LCD - User Name/Number Display	169
Message Waiting	170
Microphone Control Buttons	171
Modular Handset and Line Cords.....	172
Modular Headset Interface	173
Off-hook Call Announce (OCA)	174
On-hook Dialing	176
Personal Computer Interface (RPCI-DI)	177
Pooled CO Line Buttons.....	178
Privacy Button	179
Privacy Override.....	180
Privacy Release Button.....	181
Private CO Lines	182
Pushbutton Dialing	183
Release Button	184
Release/Answer Button	185
Remote Retrieval of Held Calls.....	186
Repeat Last Number Dialed	187
Ringing Line Preference.....	188
Saved Number Redial	189
Speed Dial (SD) Button.....	190
Timed Reminder.....	191
Toll Restriction Override Code Revision	192
User Programmable Feature Buttons.....	193

Chapter 3 – Strata AirLink

System Components.....	195
Handset Features	203
FCN Feature Access	204
Flash Button.....	205
Lock/Unlock the Dial Pad	206
Menu Operation.....	207
Mute.....	208
Speed Dial.....	209
Volume Adjustment.....	210

Chapter 4 – PC Attendant Console

Features	211
Operation.....	213
PC Requirements.....	214
Windows PC Operation.....	214
Applications	214
PC Attendant Console Features	216
Answer Button	217
Answer Priority.....	218
Answer Prompting.....	219
Attendant Conference Setup.....	220

Auto Day/Night Mode Switching.....	221
Auto Dialing	222
Busy Lamp Field (BLF)	223
Call Waiting Count.....	224
Color CRT Display	225
Dial “0” for Attendant	226
Dial Outside Number for Station User	227
Direct Station Selection (DSS).....	228
Directory Display and Dialing.....	229
DTMF Tone Signaling.....	230
Emergency Calls.....	231
Emergency Page	232
Employee Profile Information	233
Feature Online Help.....	234
Feature Prompting with Soft Keys	235
Flexible Programmable Buttons	236
Headset Operation	237
Hold Button	238
Hold Timer Display	239
Incoming Call Identification.....	240
Incoming Call Statistics.....	241
Interposition Call Transfer.....	242
Join Button.....	243
Keyboard or Mouse Operation	244
Load Sharing.....	245
Loop Hold Display	246
Message Center.....	247
Multitasking.....	248
Name or Number Dialing	249
Overflow	250
Override	251
Park and Page	252
Position Busy	253
Release Button	254
Reminder Notes	255
Split/Switch Button.....	256
Speed Dial Calling.....	257
Three-way Calling	258
Through Dialing	259
Transfer Direct to Voice Mail	260
Trunk Group Control.....	261
Volume Control	262

Chapter 5 – Automatic Call Distribution

ACD Operation	263
ACD System Features	269
After Shift Service.....	270
Automatic Disconnect	271
Automatic Number Identification (ANI).....	272
Call Distribution	273

Caller ID	274
Data Collection and Reporting	275
Delay Announcements and Music	276
Dialed Number Identification Service (DNIS)	277
Inbound Call Routing	278
Overflow	279
PBX Calls	281
Queuing	282
Queue Alarm Timer	283
ACD Agent Features	284
ACD, PBX, and Non-ACD Calls	285
ACD Call Pickup	286
ACD Display Information	287
ACD Help	288
After Call Work Time	289
Auto Answer with Zip Tone	290
Log In/Log Out	291
Unavailable Mode	292
Work Unit	293
ACD Supervisor Features	294
ACD Agent Assistance	295
ACD Call Pickup	296
ACD Supervisor LCD Display	297
ACD Supervisor Log In/Log Out	298
Call Monitoring	299
End of ACD Shift	300
Insight DK and Insight DK Plus	301
General Features	308
Insight DK Features	310
Insight DK Plus	311
MIS Access	317
Queue Alarm Indication	318
ACD Feature Interaction	319
Assistance From Busy Supervisor	320
Call Forwarding	321
Executive/Busy Override	322
Message and Display	323
Station Do Not Disturb (DND)	324
ACD Call Center Viewer	325
ACD Software MIS (SMIS)	332
Chapter 6 – Hospitality Management Information System	
Hardware Configurations	345
Connection Requirements	347
Main Screen	347
Glossary	351
Index	355

Introduction

This manual pertains to features and capabilities of Strata DK14 Release 1, DK40i Release 1, and DK424 Release 4 digital business telephone systems. Each feature profile includes:

- ♦ **System Availability** – indicates whether a feature is standard, optional or available only on certain Strata systems.
- ♦ **Description** – gives a detailed description of the feature.
- ♦ **Benefits** – provides an overview of benefits when using the feature either alone or with other Strata features.

Organization

This manual is divided into the following chapters:

- ♦ **Chapter 1 – System Overview** outlines basic categories and options for Strata features. Multiple tables provide hardware and software capacities and all the available features.
- ♦ **Chapter 2 – Features** provides all of the available features in the Strata DK systems in alphabetical order.
- ♦ **Chapter 3 – Strata AirLink™** outlines the basic concepts of the analog and digital wireless systems and describes the components and configuration software. For detailed information, refer to the *Strata Airlink Installation and User Guides*, and *Strata DK I&M (Chapter 16) and General Description Manuals*.
- ♦ **Chapter 4 – PC Attendant Console** provides an alphabetical list by feature name, a profile for each Strata DK424 Personal Computer (PC) Attendant Console feature.
- ♦ **Chapter 5 – Automatic Call Distribution (ACD)** details the various features and options available with ACD applications.
- ♦ **Chapter 6 – Hospitality Management Information System** provides an overview of HMIS capabilities. For detailed feature information, refer to the *HMIS User Guide* and *HMIS General Description*.

Conventions

Conventions	Description
Note	Elaborates specific items or references other information. Within some tables, general notes apply to the entire table and numbered notes apply to specific items.
Important!	<i>Calls attention to important instructions or information.</i>
CAUTION!	Advises you that hardware, software applications, or data could be damaged if the instructions are not followed closely.
WARNING!	Alerts you when the given task could cause personal injury or death.
[DN]	Represents any Directory Number button, also known as an extension or intercom number.
[PDN]	Represents any Primary Directory Number button (the extension number for the telephone).
[SDN]	Represents any Secondary appearance of a PDN. A PDN which appears on another telephone is considered an SDN.
[PhDN]	Represents any Phantom Directory Number button (an additional DN).
\$ULDC%RCE	Represents telephone buttons.
Courier	Shows a computer keyboard entry or screen display.
Helvetica Bold	Represents LCD displays, tokens or custom IVR functions. For example: M () .
“Type”	Indicates entry of a string of text.
“Press”	Indicates entry of a single key. For example: Type prog then press Enter .
Plus (+)	Shows a multiple PC keyboard or phone button entry. Entries without spaces between them show a simultaneous entry. Example: Esc + Enter . Entries with spaces between them show a sequential entry. Example: # + 5 .
Tilde (~)	Means “through.” Example: 350 ~ 640 Hz frequency range.
➤	Denotes the step in a one-step procedure.
➤	Denotes a procedure.
See Figure 10	Grey words within the printed text denote cross-references. In the electronic version of this document (Strata DK Library CD-ROM or FYI Internet download), cross-references appear in blue hypertext.

Action/Response Table

1. *Actions* you perform appear in this column. They can consist of either a single step or a series of numbered steps.
2. When the action you perform results in a screen, menu, dialog box, etc., the example to the right displays.

The *immediate response to the action* performed appears in this column. Additional notes and comments are also included.

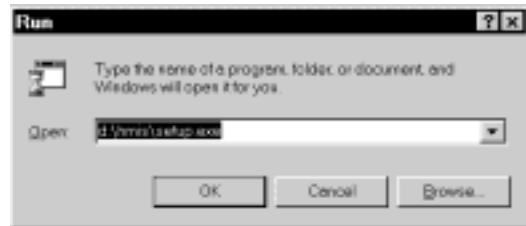

Related Documents/Media

Note Some documents listed here may appear in different versions on the CD-ROM, FYI, or in print. To compare and find the most current version, check the document title page.

- ♦ **Digital Telephone User Guide** provides all the procedures necessary to operate Toshiba-proprietary digital telephones including Liquid Crystal Display (LCD) features. It also includes instructions for using the add-on module/DSS console.
- ♦ **Digital Telephone Quick Reference Guide** provides a quick reference for frequently used digital telephone features.
- ♦ **Digital Single Line Telephone User Guide** provides all the procedures necessary to operate the Toshiba DKT2001 telephone features.
- ♦ **Electronic Telephone User Guide** explains all the procedures necessary to operate Toshiba-proprietary electronic telephones including all LCD features. Does not apply to the Strata DK14 system. It also includes instructions for using the electronic DSS console.
- ♦ **Electronic Telephone Quick Reference Guide** provides a quick reference for frequently used electronic telephone features. Does not apply to the Strata DK14 system.
- ♦ **Standard Telephone User Guide** explains all the procedures necessary to operate rotary dial and push-button standard telephones.
- ♦ **Strata AirLink External Wireless Handset User Guide** shows how to use the wireless handset configured to Strata DK telephone system Strata DK telephone system and many non-Toshiba systems.
- ♦ **Strata AirLink External Wireless Handset Quick Reference Guide** contains instructions for operation of commonly used Strata AirLink External Wireless Handset features.
- ♦ **Strata AirLink Integrated Wireless Handset User Guide** shows how to use the wireless handset configured to digital ports of the Strata DK telephone system.
- ♦ **Strata AirLink Integrated Wireless Handset Quick Reference Guide** contains instructions for operation of commonly used Strata AirLink Integrated Wireless Handset features.
- ♦ **System Administrator Guide** gives instructions for the System Administrator to manage a system. Contains instructions for station relocation, system Speed Dial, and other features only activated by the System Administrator.
- ♦ **PC/Data Interface User Guide** explains all the procedures necessary to operate stand alone data interface units while in the data mode for printer sharing and modem pooling. Also provides instructions for connecting to a PC with Telephone Application Programming Interface (TAPI).
- ♦ **Cordless Telephone User Guide** provides instructions on using the DKT2004-CT cordless digital telephone as a single unit or in conjunction with a digital telephone.
- ♦ **PC-DKT User Guide** provides installation and operation information for the Personal Computer Digital Key Telephone system.

- † **DKAdmin/DKBackup User Guide** describes how to use the DK Admin/DK Backup interactive software applications, which enable you to easily and quickly custom program and/or update the Strata DK14/DK40i/DK424 with a user friendly PC display. It also describes how to backup and restore existing Strata DK14/DK40i/DK424 system data using the programs.
- † **Keyprint 2000 User Guide** provides instructions for the Keyprint 2000 software printing package which enables you to print and store custom button label keystrips for Strata DK 2000-series 10-button or 20-button digital telephones, 20-button add-on modules, and 60-button digital DSS consoles.
- † **Strata DK Programming Manual** provides all instructions necessary to program the Strata DK14, DK40i, and DK424 systems and system record sheets including ACD. The Strata AirLink wireless systems are included throughout the manual.
- † **Strata DK Installation & Maintenance Manual** provides installation instructions for configuring and installing the Strata DK14, DK40i and DK424. It also includes ISDN, T1/DS-1 interface installation and configuration instructions, and troubleshooting. Additional chapters are: ACD, providing installation instructions; Strata AirLink, providing installation instructions for the standard- and digital-port configurations of the wireless system.
- † **Strata AirLink External Wireless System Installation Guide** provides step-by-step installation instructions for the Base Station Interface Adapter (BSIA) system, including system configurations examples, site surveys, and troubleshooting techniques.
- † **Hospitality Management Information System (HMIS) General Description** provides an overall view of the hardware, software, applications and features.
- † **Hospitality Management Information System (HMIS) User Guide** describes the product's many software features and gives step-by-step instructions for using them.
- † The following applies only to the Strata DK424.
- † **Strata DK424 Call Center Solutions General Description** provides a system overview, including hardware and feature information.
- † **ACD Agent Guide** describes the ACD agent feature operation along with step-by-step procedures for using features.
- † **ACD Supervisor Guide** provides instruction on how to use the ACD supervisor features.
- † **Call Center Viewer User Guide** describes how to install and operate the Call Center Viewer application on a PC. It explains how to view and customize ACD group and agent status information.
- † **Insight DK Installation Guide** provides installation instructions for Strata DK Insight and Insight DK Plus Management Information System (MIS) application onto server and client PCs. Also included are software installation instructions for electronic wallboards and the inView™ LAN display application.
- † **Insight DK Supervisor Guide** provides instructions for using the Strata DK Insight and Insight DK Plus MIS for the call center Supervisor.
- † **Insight DK inView Quick Reference Guide** provides instructions for viewing and customizing the on-screen wallboard and large character views of the real time call center data.
- † **Software MIS (SMIS) Supervisor Manual** provides descriptions, examples, and instructions on using the Software MIS application.
- † **Strata DK Library CD-ROM** enables you to view, print, navigate and search publications for Strata DK14, DK40i and DK424 digital business telephone systems.

- ♦ **Insight DK CD-ROM** contains the Insight DK software and upgrade to Insight DK Plus software, demo software and instructions, as well as all Insight DK documentation and a training module.
- ♦ **StrataControl CD-ROM** contains the StrataControl software and documentation and enables viewing, downloading, editing, and uploading Strata DK programmed data on a PC.
- ♦ **Strata DKQuote CD-ROM** contains the DKQuote software and documentation and enables viewing, downloading, editing, and uploading of DKQuote data to a PC.
- ♦ **Hospitality Management Information System (HMIS) CD-ROM** describes HMIS, including installation, the Setup Utility, maintaining the HMIS databases and software, and troubleshooting.

Note For authorized users, Internet site FYI (<http://fyi.tsd.toshiba.com>) contains all Strata DK documentation and enables you to view, print, and download current publications.

The Strata DK14, DK40i, and DK424 are digital business telephone systems that are electronically compatible with the public telephone network and can function in PBX or Centrex environments.

Each system can be configured as key or hybrid (DK424 PBX also) with separate Federal Communications Commission (FCC) registration numbers. Feature capabilities are very similar. The primary difference between models is capacity. Each system and station feature is described completely, beginning on [Pages 15](#) and [119](#) respectively.

Strata DK14

The Strata DK14 uses a compact, single cabinet, wall mount design. It provides built-in circuitry for two CO lines and four digital stations. It can be expanded to a maximum capacity of four CO lines and ten stations (eight digital telephone stations and two standard stations).

Strata DK40i

The Strata DK40i uses a compact, double cabinet (base plus expansion), wall mount design. It provides capacity for four CO lines, eight digital stations, and four standard stations in the base cabinet. With the expansion cabinet, it has a maximum capacity of 12 CO lines and 28 stations.

Strata DK424

The Strata DK424 uses a modular, building block system design that can be configured using from one to seven cabinets (base cabinet and up to six expansion cabinets). This enables customers to grow cost effectively from small to large configurations. They can reuse common equipment by adding options rather than replacing existing hardware. The only part they potentially replace is the processor, depending upon the size they start with or grow to.

There are four DK424 processor models available having different degrees of capacity, capability, and price. The processors are:

- ♦ **RCTUA** small system processor – for one-cabinet configurations not requiring some of the advanced features, such as ACD/MIS, PRI, T1 Interface, Attendant Console, or System Open Architecture Interface (OAI). It provides a maximum capacity for 16 CO lines and 32 stations.
- ♦ **RCTUBA/BB** medium system processor – for one- or two-cabinet configurations and supports all of the advanced features, such as ACD/MIS, PRI, T1 Interface, Attendant Console, and System OAI. It provides a maximum capacity for 48 CO lines or 80 stations.
- ♦ **RCTUC/D** large system processor – for up to six-cabinet configurations and supports all of the advanced features. It provides a maximum capacity for 144 CO lines or 240 stations.

- ♦ **RCTUE/F** maximum system processor – for up to seven-cabinet configurations and supports all of the advanced features. It provides a maximum capacity for 200 CO lines or 336 stations.

Migration

An important aspect of the Toshiba product line strategy is cost-effective migration from smaller to larger systems. This includes reusing as much of the existing equipment as possible.

All Strata DK systems use the same 2000-series digital telephones and wiring. This means a customer growing from as small as a DK14 to as large as a DK424 can use the same telephones.

Older digital and electronic telephones are also compatible with Strata DK40i and DK424 systems. This means customers growing out of older Strata systems into current larger ones, can reuse their existing electronic telephones.

Printed circuit boards from Strata DK24/56/96 systems can be reused in DK424 systems. This includes CO line interface cards, station interface cards, and option cards. This means DK24/56/96 customers need only to buy a new processor and the appropriate number of cabinets to migrate to the larger DK424.

Customers buy Toshiba telecommunication products knowing their investment is designed for long-term use. Not only are they buying quality products that will last, but they can also grow and expand cost effectively.

System Capacities

Table 1 is an overview of each system’s hardware capacities and Table 2 is an overview of each system’s software capabilities.

Table 1	Hardware Capacities		DK424			
			RCTUA	RCTUBA/BB	RCTUC/D	RCTUE/F
Lines and PCB Slots	DK14	DK40i	RCTUA	RCTUBA/BB	RCTUC/D	RCTUE/F
Universal slots	0	4 ¹	6	12	36	54
CO lines – loop start	4	12 ²	16 ²	48 ²	144 ²	200 ²
CO lines – ground start	0	12	16 ²	40 ²	136 ²	200 ²
DID lines (analog)	0	12	16 ³	40 ³	136 ³	200 ³
Tie lines (analog)	0	12	16 ³	40 ³	136 ³	200 ³
T1 (DS-1 lines each)	0	0	0	48 ⁴	144 ⁴	192 ⁴
ISDN BRI B channel lines	0	12	8 ⁵	16 ⁵	16 ⁵	16 ⁵
ISDN PRI B channel lines	0	0	0	47 ⁶	141 ⁶	188 ⁶
Squared-system maximum (lines + stations)	4 + 4	12 + 12	16 + 16	48 + 48	144 + 144	200 + 200
Stations and Peripherals	DK14	DK40i	RCTUA	RCTUBA/BB	RCTUC/D	RCTUE/F
Add-on modules (DADM)	8	12	12	40	120	200
Attendant consoles	0	0	0	2	4	4
DKT2004-CT cordless telephones	8	28	32	80	240	336
DKT2004-CT simultaneous calls	8	9	9	9	9	9
Door locks	2	3	4	5	5	5
Door phones	6	9	9	12	12	12
DSS consoles	0	3	3	4	8	8

Table 1 Hardware Capacities (continued)

Stations and Peripherals	DK424					
	DK14	DK40i	RCTUA	RCTUBA/BB	RCTUC/D	RCTUE/F
ISDN BRI station circuits TE-1 and TA (2B + D per circuit) ⁷	0	10	8	16	40	64
Handset OCA stations	8	28	32	80	240	336
Off-premises stations	2	20	32	80	232	328
PDIU-DS ⁸	7	24	31	79	160	208
RPCI-DI used for data + TAPI, per system ⁸	8	24	32	80	144	200
RPCI-DI used for TAPI only per:						
◆ Cabinet ⁸	N/A	N/A	32	40	40	40
◆ System ⁸	8	24	32	80	186	280
Speaker OCA stations ⁸	8	28	32	80	160	208
Standard stations	2	20	24	72	232	328
Telephones – DKT	8	28 ⁹	32 ¹⁰	80 ¹⁰	240 ¹⁰	336 ¹⁰
Telephones – EKT	0	16 ⁹	32 ¹⁰	80 ¹⁰	240 ¹⁰	328 ¹⁰
Strata AirLink wireless handsets	N/A	20	24	72	232	328

1. There are four universal slots in the DK40i expansion unit.
2. All CO line capacities assume a PIOU, PIOUS, PEPU, RSSU, or RSIU is installed for RCTUBA/BB, RCTUC/D or RCTUE/F, but no Caller ID RCIU2/RCIS PCBs.
3. Limits apply to analog DID and Tie lines, not T1 DID/Tie lines.
4. T1 lines can be loop start, ground start, Tie, or DID (maximum 24 lines per unit, any type or combination).
5. BRI lines provide CO line services, including Caller ID, DID and Direct Inward Lines (DIL).
6. PRI lines provide CO line services, including Caller ID, ANI, DID, Tie, POTS, FX and DIL.
7. ISDN BRI TE-1 and TA include ISDN telephones, modems, video conference interfaces, etc. Up to two stations (TE-1 and/or TA) can connect to and share one BRI S-type circuit. Only one station can connect to a BRI U-type circuit.
8. Speaker OCA, PDIU and RPCI capacity is determined by 2B channel slot availability and power supply limits.
9. To install the maximum of 28 total DKTs and EKTs in the DK40i, up to 16 of the stations can be EKTs and at least 8 of the stations must be DKTs.
10. Maximum capacity of DKT/EKT stations per DK424 cabinet is 62, less for EKT 2000, 3000 (Power Factor limitation).

Table 2 System Software Capacities

Software	DK14	DK40i	DK424 RCTUA	DK424 RCTUBA/BB	DK424 RCTUC/D	DK424 RCTUE/F
Class of Srv. Toll Restriction Levels	4	4	4	4	8	8
Call Pickup CO Line Groups	2	2	2	2	4	4
Call Pickup Station Groups	8	20	20	20	20	20
Pooled CO Line Groups	4	8	8	8	16	16
Conference Parties	4	4	4	4	4	4
Simultaneous Conferences	2	4	3	7	7	14
Tandem CO Line Connections	2	4	4	10	10	20
System Speed Dial Numbers	40	40	40	100	100	800
Station Speed Dial Numbers	40	40	40	40	40	40
Speed Dial Digits	20	20	20	20	20	20
Speed Dial Digits Chained	37	37	37	37	37	37
Account Code Digits	4~15	4~15	4~15	4~15	4~15	4~15
Verified Account Codes	100	300	300	300	300	300
DISA Security Code Digits	1~15	1~15	1~15	1~15	1~15	1~15

Table 2 System Software Capacities (continued)

Software	DK14	DK40i	DK424 RCTUA	DK424 RCTUBA/BB	DK424 RCTUC/D	DK424 RCTUE/F
DNIS Numbers	N/A	N/A	200	350	500	500
Abandoned ANI/Caller ID Number	N/A	N/A	200	400	1000	2000
Primary Directory Numbers	N/A	N/A	32	80	240	336
Phantom (Multiple) Directory Numbers	N/A	N/A	32	80	240	336

Feature Availability

Refer to [Tables 3~5](#) for features and services that are available for Strata DK systems.

Table 3 Strata DK System Feature Availability

Feature	DK14	DK40i	DK424 RCTUA	DK424 RCTUBA/BB	DK424 RCTUC/D	DK424 RCTUE/F
Account Codes-Forced	Std	Std	Std	Std	Std	Std
Account Codes-Verifiable	Std	Std	Std	Std	Std	Std
Account Codes-Voluntary	Std	Std	Std	Std	Std	Std
Alarm Sensor	Opt	Opt	Opt	Opt	Opt	Opt
Alternate Answer Point	Std	Std	Std	Std	Std	Std
Amplified Conference Interface	N/A	Opt	Opt	Opt	Opt	Opt
Automated Attendant, Built-in	Opt	Opt	Opt	Opt	Opt	Opt
Auto Attendant Delayed Ringing	Opt	Opt	Opt	Opt	Opt	Opt
Automatic Call Distribution	N/A	N/A	N/A	Opt	Opt	Opt
Automatic No. Identification (ANI)	N/A	Opt	Opt	Opt	Opt	Opt
Automatic Recall (Hold, Transfer)	Std	Std	Std	Std	Std	Std
Automatic Release from Hold	Std	Std	Std	Std	Std	Std
Background Music Interface	Std	Std	Std	Std	Std	Std
Battery Backup Interface-System	Std	Std	Std	Std	Std	Std
Battery Backup-Memory	Std	Std	Std	Std	Std	Std
Call Waiting Tone	Std	Std	Std	Std	Std	Std
Caller ID	Opt	Opt	Opt	Opt	Opt	Opt
Centrex/PBX Compatibility	Std	Std	Std	Std	Std	Std
Centrex Ringing Repeat	Std	Std	Std	Std	Std	Std
Class of Service, Station	Std	Std	Std	Std	Std	Std
Class of Service, Travelling	Std	Std	Std	Std	Std	Std
CO Line Call Pickup Groups	2 Groups	2 Groups	2 Groups	2 Groups	4 Groups	4 Groups
CO Line Groups	4 Groups	8 Groups	8 Groups	8 Groups	16 Groups	16 Groups

Std = Standard
 Opt = Optional
 N/A = Not Available

Table 3 Strata DK System Feature Availability (continued)

Feature	DK14	DK40i	DK424 RCTUA	DK424 RCTUBA/BB	DK424 RCTUC/D	DK424 RCTUE/F
CO Line Queuing	Std	Std	Std	Std	Std	Std
Computer Telephony Integration (CTI)	Opt	Opt	Opt	Opt	Opt	Opt
Conferencing	4 Party	4 Party	4 Party	4 Party	4 Party	4 Party
Credit Card Calling ("0+" Dialing)	Std	Std	Std	Std	Std	Std
Delayed Ringing	Std	Std	Std	Std	Std	Std
Dialed Number ID Service (DNIS)	N/A	Opt	Opt	Opt	Opt	Opt
Direct Inward Dialing (DID)	N/A	OPT	OPT	OPT	OPT	OPT
Direct Inward System Access (DISA)	Opt	Opt	Opt	Opt	Opt	Opt
Distinctive CO Ringing	Std	Std	Std	Std	Std	Std
Door Lock Control	Opt	Opt	Opt	Opt	Opt	Opt
Dual-tone Multi-frequency (DTMF) and Dial Pulse Compatible	Std	Std	Std	Std	Std	Std
DTMF Signal Time Setting (160/80 ms)	Std	Std	Std	Std	Std	Std
End-to-End Signal Tones	Opt	Opt	Opt	Opt	Opt	Opt
E911 Enhanced Operation	Opt	Opt	Opt	Opt	Opt	Opt
FCC Registration (Key, Hybrid)	Std	Std	Std	Std	Std	Std
FCC Registration (PBX)	N/A	N/A	Std	Std	Std	Std
Flash Timing Programmable	Std	Std	Std	Std	Std	Std
Flexible Button Assignment	Std	Std	Std	Std	Std	Std
Flexible Intercom DN Numbering	Std	Std	Std	Std	Std	Std
Flexible Line Ringing Assignment	Std	Std	Std	Std	Std	Std
Flexible Slot Assignment	N/a	Opt (Expansion Cabinet)	Std	Std	Std	Std
Ground Start Lines	N/a	Opt	Opt	Opt	Opt	Opt
Hotline Service (Emergency Ringdown)	N/A	N/A	Std	Std	Std	Std
Internal Call Hold	Std	Std	Std	Std	Std	Std
Internal Call Transfer	Std	Std	Std	Std	Std	Std
ISDN Basic Rate Interface	N/A	Opt	Opt	Opt	Opt	Opt
ISDN Primary Rate Interface	N/A	N/A	N/A	Opt	Opt	Opt
Least Cost Routing (LCR)	Std	Std	Std	Std	Std	Std
Live System Programming	Std	Std	Std	Std	Std	Std
Message Waiting (MW) DKT	Std	Std	Std	Std	Std	Std

Std = Standard
Opt = Optional
N/A = Not Available

System Overview

Feature Availability

Table 3 Strata DK System Feature Availability (continued)

Feature	DK14	DK40i	DK424 RCTUA	DK424 RCTUBA/BB	DK424 RCTUC/D	DK424 RCTUE/F
MW Lamp Generator for 2500 SLTs	N/A	Opt	Std	Std	Std	Std
Modular Expansion System Design	N/A	Std	Std	Std	Std	Std
Multiple DNs	Std	Std	Std	Std	Std	Std
Music-on-Hold Interface	Std	Std	Std	Std	Std	Std
Night Ringing Answer Code	Std	Std	Std	Std	Std	Std
Night Ring Over External Page	Std	Std	Std	Std	Std	Std
Night Ring Over Ext. Page Zones	N/A	Opt	Opt	Opt	Opt	Opt
Night Service	Std	Std	Std	Std	Std	Std
Non-blocking Dialing DKT/EKT	Std	Std	Std	Std	Std	Std
Non-blocking Internal Call	Std	Std	Std	Std	Std	Std
Off-premises Stations	Opt	Opt	Opt	Opt	Opt	Opt
Outgoing Call Restriction	Std	Std	Std	Std	Std	Std
Page Pickup (Meet-Me Page)	Std	Std	Std	Std	Std	Std
Paging-External Interface	Std	Std	Opt	Opt	Opt	Opt
Paging-External Zone (4 zones)	N/A	Opt	Opt	Opt	Opt	Opt
Paging-Internal DKT All Call	Std	Std	Std	Std	Std (120)	Std (120)
Paging-Internal DKT Group	4 Groups	4 Groups	4 Groups	4 Groups	8 Groups	8 Groups
Pooled CO Line Groups	4	8	8	8	16	16
Power Failure Transfer	Std	Std	Opt	Opt	Opt	Opt
Privacy/Non Privacy Option	Std	Std	Std	Std	Std	Std
Relay Service	Std	Std	Opt	Opt	Opt	Opt
Remote Maint./Admin.	Opt	Opt	Opt	Opt	Opt	Opt
SMDR	Opt	Opt	Opt	Opt	Opt	Opt
Station Hunting – Dist.	Std	Std	Std	Std	Std	Std
Station Hunting – Serial	Std	Std	Std	Std	Std	Std
Station Relocation	Std	Std	Std	Std	Std	Std
System Programming Through Station	Std	Std	Std	Std	Std	Std
System Speed Dialing	40	40	40	100	100	100
Tandem CO Line Connection	Std	Std	Std	Std	Std	Std
Tenant Service	2	2	2	4	4	4
Tie Line Transfer Recall	N/A	Std	Std	Std	Std	Std
T1 Interface	N/A	N/A	N/A	Opt	Opt	Opt
Toll Restriction	Std	Std	Std	Std	Std	Std

Std = Standard
 Opt = Optional
 N/A = Not Available

Table 3 Strata DK System Feature Availability (continued)

Feature	DK14	DK40i	DK424 RCTUA	DK424 RCTUBA/BB	DK424 RCTUC/D	DK424 RCTUE/F
Toll Restriction Override Codes	Std	Std	Std	Std	Std	Std
Toll Restr. Speed Dial Override	Std	Std	Std	Std	Std	Std
Transfer Privacy	Std	Std	Std	Std	Std	Std
TTY Local Terminal Interface	Opt	Opt	Opt	Opt	Opt	Opt
Upload/Download Programming	Opt	Opt	Opt	Opt	Opt	Opt
Voice Mail Integration In Band	Std	Std	Std	Std	Std	Std
Voice Mail Integration (SMDI)	Std	Std	Std	Std	Std	Std
Voice or Tone Signaling Selectable	Std	Std	Std	Std	Std	Std

Std = Standard
Opt = Optional
N/A = Not Available

Table 4 Strata DK LCD Feature Availability

Feature	DK14	DK40i	DK424 RCTUA	DK424 RCTUBA/BB	DK424 RCTUC/D	DK424 RCTUE/F
Alphanumeric Personal Messages	10	10	10	10	10	10
Alphanumeric System Messages	40	40	40	40	40	40
ANI/DNIS Display	N/A	Opt	Opt	Opt	Opt	Opt
Auto Callback Number Display	Std	Std	Std	Std	Std	Std
BLF Indication	Std	Std	Std	Std	Std	Std
Busy Station Messaging	Std	Std	Std	Std	Std	Std
Call Duration Display	Std	Std	Std	Std	Std	Std
Call FWD Source/Destination	Std	Std	Std	Std	Std	Std
Called Station Messaging	Std	Std	Std	Std	Std	Std
Caller ID Display	Opt	Opt	Opt	Opt	Opt	Opt
Calling Station Messaging	Std	Std	Std	Std	Std	Std
Calling/Called Number Intercom/DN	Std	Std	Std	Std	Std	Std
Clock/Calendar Display	Std	Std	Std	Std	Std	Std
CO Line ID Incoming/Outgoing	Std	Std	Std	Std	Std	Std
Dial Input Verification	Std	Std	Std	Std	Std	Std
Feature Activation Display	Std	Std	Std	Std	Std	Std
Feature Prompting with Soft Keys	Std	Std	Std	Std	Std	Std
Group Station Messaging	Std	Std	Std	Std	Std	Std
Intercom/DN User Name Display	Std	Std	Std	Std	Std	Std
Remote/Group Station Messaging	Std	Std	Std	Std	Std	Std

Std = Standard
Opt = Optional
N/A = Not Available

Table 4 Strata DK LCD Feature Availability (continued)

Feature	DK14	DK40i	DK424 RCTUA	DK424 RCTUBA/BB	DK424 RCTUC/D	DK424 RCTUE/F
Speed Dial Directory Dialing	Std	Std	Std	Std	Std	Std
Speed Dial Directory Name Scroll	Std	Std	Std	Std	Std	Std
Timed Reminders	Std	Std	Std	Std	Std	Std

Std = Standard
 Opt = Optional
 N/A = Not Available

Table 5 Strata DK Station Feature Availability

Feature	DK14	DK40i	DK424 RCTUA	DK424 RCTUBA/BB	DK424 RCTUC/D	DK424 RCTUE/F
Alert Signal Button	Std	Std	Std	Std	Std	Std
Auto Busy Redial (ABR)	Opt	Opt	Std	Std	Std	Std
Auto Callback Intercom	Std	Std	Std	Std	Std	Std
Auto Dial Inside (DSS) Buttons	Std	Std	Std	Std	Std	Std
Auto Dial Outside Buttons	Std	Std	Std	Std	Std	Std
Automatic Hold	Std	Std	Std	Std	Std	Std
Auto Off-Hook Line Selection	Std	Std	Std	Std	Std	Std
Background Music (BGM) with Station Control	Std	Std	Std	Std	Std	Std
Busy Override Tone	Std	Std	Std	Std	Std	Std
Busy Station Transfer/Ringing	Std	Std	Std	Std	Std	Std
Call Forward-All Calls (CFAC)	Std	Std	Std	Std	Std	Std
Call Forward-Busy (CFB)	Std	Std	Std	Std	Std	Std
Call Forward-Busy/No Answer (CFBNA)	Std	Std	Std	Std	Std	Std
Call Forward-No Answer (CFNA)	Std	Std	Std	Std	Std	Std
Call Forward-External/Remote	Std	Std	Std	Std	Std	Std
Call Forward-Fixed (CFF)	Std	Std	Std	Std	Std	Std
Call Forward Override	Std	Std	Std	Std	Std	Std
Call Park	Std	Std	Std	Std	Std	Std
Call Park Orbits	Std	Std	Std	Std	Std	Std
Call Pickup-Directed Station	Std	Std	Std	Std	Std	Std
Call Pickup-Holding/Parked	Std	Std	Std	Std	Std	Std
Call Pickup-Ringing CO Line	Std	Std	Std	Std	Std	Std
Call Pickup-Ringing CO Tenant Groups	2 Groups	2 Groups	2 Groups	2 Groups	4 Groups	4 Groups
Call Pickup-Station Group	20 Groups	20 Groups	20 Groups	20 Groups	20 Groups	20 Groups
Call Transfer Immediate	Std	Std	Std	Std	Std	Std
Call Transfer with Announcement	Std	Std	Std	Std	Std	Std
Call Transfer with Camp-on	Std	Std	Std	Std	Std	Std
Centrex/PBX Feature Buttons	Std	Std	Std	Std	Std	Std
Continuous DTMF Signal Time (DKT2000)	Std	Std	Std	Std	Std	Std

Std = Standard
 Opt = Optional
 N/A = Not Available

Table 5 Strata DK Station Feature Availability (continued)

Feature	DK14	DK40i	DK424 RCTUA	DK424 RCTUBA/BB	DK424 RCTUC/D	DK424 RCTUE/F
Distinctive Station Ringing	3 Tones	3 Tones	3 Tones	3 Tones	3 Tones	3 Tones
Do Not Disturb (DND)	Std	Std	Std	Std	Std	Std
Do Not Disturb Override	Std	Std	Std	Std	Std	Std
DP/DTMF Mode Change (Tone Button)	Std	Std	Std	Std	Std	Std
Exclusive Hold	Std	Std	Std	Std	Std	Std
Executive Override (Break-in)	Std	Std	Std	Std	Std	Std
Flash Button	Std	Std	Std	Std	Std	Std
Handset CW/Camp-on Tone On/Off	Std	Std	Std	Std	Std	Std
Handset Volume Control (DKT)	Std	Std	Std	Std	Std	Std
Handsfree Answerback on Internal Calls	Std	Std	Std	Std	Std	Std
Headset Compatible	Opt	Opt	Opt	Opt	Opt	Opt
Hearing-Aid Compatible	Std	Std	Std	Std	Std	Std
Line in Use (I-Use)	Std	Std	Std	Std	Std	Std
Line on Hold (I-Hold)	Std	Std	Std	Std	Std	Std
Microphone Control Button	Std	Std	Std	Std	Std	Std
Microphone Sensitivity Control (DKT)	Std	Std	Std	Std	Std	Std
Off-hook Call Announce (OCA) Handset	Std	Std	Std	Std	Std	Std
Off-hook Call Announce (OCA) Speaker	Opt	Opt	Opt	Opt	Opt	Opt
On-hook Dialing	Std	Std	Std	Std	Std	Std
Pooled CO Line Buttons	Std	Std	Std	Std	Std	Std
Privacy Button	Std	Std	Std	Std	Std	Std
Privacy Override	Std	Std	Std	Std	Std	Std
Privacy Release Button	Std	Std	Std	Std	Std	Std
Private CO Lines	Std	Std	Std	Std	Std	Std
Release Button	Std	Std	Std	Std	Std	Std
Release/Answer Button	Std	Std	Std	Std	Std	Std
Remote Retrieval of Held Calls	Std	Std	Std	Std	Std	Std
Repeat Last Number Dialed	Std	Std	Std	Std	Std	Std
Ringling Line Preference	Std	Std	Std	Std	Std	Std
Saved Number Redial	Std	Std	Std	Std	Std	Std
Speakerphone	Opt	Opt	Opt	Opt	Opt	Opt
Station Speed Dial Numbers	40	40	40	40	40	40
Two Color LEDs – DKT	Std	Std	Std	Std	Std	Std
User Programmable Feature Buttons	Std	Std	Std	Std	Std	Std

Std = Standard
Opt = Optional
N/A = Not Available

System Administration Tools

Important and time-saving installation and support tools are available for use with Strata DK systems. Installation and support is easier and more efficient for both Toshiba dealers and end users. These PC software programs are easy to use with a menu-driven format and help screens.

DKQuote

DKQuote is an automated Strata DK system configuration software package that makes it easy for you to determine which system components you need for configuration of a Strata DK system. Use it for original installation or add-ons.

DKQuote is like an on-line worksheet that serves as a checklist that even tells you in which slot to install circuit cards. You can insert your own prices that are password protected. It is great for:

- ♦ Sales representatives preparing a bid using Strata DK14, DK40i, or DK424 systems.
- ♦ Operations personnel ordering equipment.
- ♦ Technicians doing installation planning.

This software package runs on your 486 or faster IBM-compatible PC with Windows 95.

DKAdmin

DKAdmin, a Strata DK14, DK40i, DK424 system programming and administration software package, provides all the functions of DKBackup, plus it easily and efficiently enables you to do off-line system programming from an IBM-compatible Pentium® PC with DOS 6.2 or above. With DKAdmin you can:

- ♦ Query the Strata DK system for all or specific programming functions.
- ♦ Display or change all information for a single station, such as Toll Restriction Class, Auto Busy Redial (ABR), Busy Override, telephone LCD names, and Speed Dial.

Note Queries and changes can be done by selecting from a program table, feature table, or station ID/range/user name table.

- ♦ Change programming for a range of stations for the same function or for specific individual stations.
- ♦ Save the complete Strata DK configuration programming information in a disk file on a PC the same way as DKBackup. This saves customer data such as Speed Dial, numbering plan, ringing assignments, station options, and LCD messages.
- ♦ Save certain programming changes as templates for later use with the transfer data function. This is valuable in re-creating a specific customer's saved data for reloading, using file upload capabilities. This also enables you to build a library of standard types of installations for use in new installations minimizing programming effort.

DKAdmin requires the DKAdmin (red) copy-protection key and is not compatible with the DKBackup (green) copy-protection key.

Using the backup function built into DKAdmin, the system configuration program options and customer data is retrieved from the processor. The options and customer data are saved in a file on your IBM-compatible PC, which is connected to the system using a PIOU, PIOUS, RSSU, RSIU, TSIU (DK40i), or WSIU (DK14).

DKAdmin then enables you to add or change customer data (both system-wide programming and individual-station settings) using a PC independent of the Strata DK system. Password protection enables multiple levels of access, so some users can only edit and change selected items in the Strata DK database, while others can change all programs and station settings.

For example, DKAdmin provides a station administration menu that enables the end user to add, delete, or change any Strata DK feature on a user's telephone, such as telephone flexible buttons, Speed Dial numbers, station class of service, station user LCD names, LCD messages, and more.

Using the restore function built into DKAdmin, the new data can be restored to the Strata DK from the PC file, changing the customer program options and customer data, locally on-site or remotely over telephone lines and modems.

DKAdmin makes it easy to maintain and update the end-user's system and provides an efficient way to backup and restore their current database. The DKAdmin software is easy to use with a menu-driven spreadsheet format and help screens.

DKBackup

DKBackup is a Strata DK software package, which enables you to retrieve system configuration program options (Speed Dial, numbering plan, ringing assignments, and station options) from the system processor. It also saves the data in a file on your IBM-compatible PC (386/486 or faster with DOS 6.2 or above), which is connected to the system using a PIOU, PIOUS, RSSU, RSIU, TSIU (DK40i) or WSIU (DK14).

Customer data can be restored to the Strata DK by sending the data from the PC file to the new initialized system, locally (on-site) or remotely, over telephone lines and modems. The backup procedure can be performed for the whole customer database or selected individual parts (programming options, System Speed Dial, Station Speed Dial, voice mail codes, user names, Call Forward status, Message Waiting status, and Lost Call Caller ID and ANI telephone numbers).

DKBackup provides an efficient way to backup and restore the customer's database. It also makes an easy installation tool and is especially useful for providing software upgrades without having to manually re-program everything.

It is easy to use because of its menu-driven spreadsheet format and help screens. The software is available on a 3.5-inch floppy diskette operating in conjunction with the DKBackup (green) copy-protection key which plugs into your 25-pin PC printer port.

StrataControl

StrataControl is a Windows-based PC tool designed to make simple system programming changes to Strata DK40i and DK424 digital business telephone systems easy for end users.

StrataControl enables users to download information from their Strata DK system and make programming changes using their PC. When the changes are completed, they are uploaded and implemented in their Strata DK system. Both direct connection and modem access are available, so customers have the added advantage of configuring systems remotely.

StrataControl enables customers to manage and store system programming information for multiple systems in separate files. If the customer has multiple Strata DK systems, all of the systems can be administered from the same StrataControl application. StrataControl provides the ability to modify programming in the following categories.

System Administration

- ◆ Auto Attendant
- ◆ Operating parameters
- ◆ Account Codes
- ◆ ACD
- ◆ Call Park
- ◆ Long distance parameters
- ◆ Serial output parameters

Station Administration

- ◆ Button assignments on telephones, add-on modules, DSS consoles, and Attendant consoles
- ◆ Station group options
- ◆ Station operating parameters
- ◆ Station general options
- ◆ Standard telephone options

Customer Data

- ◆ Name assignments to extensions, CO lines, page groups, pick-up groups, and hunt groups
- ◆ ACD functionality
- ◆ Data station hunting

Printing and Output

- ◆ Keystrips according to telephone station programming (prints on blank 2000-series DKT keystrip stock available from Toshiba)
- ◆ *Digital Telephone User Guide*
- ◆ Custom *Quick Reference Telephone Guide* based upon station features and options assigned within the system
- ◆ Extension lists

CO Line Administration

- ◆ CO line names
- ◆ Ringing assignments

Important! *StrataControl enables self-administration of the simpler aspects of programming and maintenance. It does not contain and is not designed to accommodate the complete installation and maintenance functions that the DKAdmin package provides. StrataControl is designed for the end user and DKAdmin is designed for the trained service technician.*

Keyprint 2000

Keyprint 2000, a keystrip printing software package, creates and prints custom button label keystrips for 2000-series 10 or 20-button digital telephones. It runs on a 386 or faster PC with DOS 3.3 and above and prints on laser or 24-pin dot matrix printers.

The software supports hundreds of different printers from lasers to dot matrix. It prints three keystrips per sheet on the DKT 2000-series blank keystrip stock for output to small or large groups of custom keystrips. It is easy to use with a menu driven format. You can display, change, and store keystrip layouts to create a database of many keystrip varieties.

Keyprint 2000 is available on a copy-protected 3.5-inch floppy disk.

Strata AirLink Wireless Manager

The Strata AirLink™ Wireless Telephone System includes the Strata AirLink Manager administration software that configures the wireless system and handset features on the controller.

The software runs diagnostics and enables the System Administrator to check Base Station status and remove or restore service to the Base Stations. It also reports alarm conditions and provides traffic statistics on Base Station channel usage throughout the system.

Available on 3.5-inch floppy disks, the software application runs under Microsoft Windows on an IBM-compatible Personal Computer (PC). It is easy to use with a menu-driven format.

System Features

This section describes the system features for the Strata DK14, DK40i, and DK424. The features apply to all these systems, except where noted.

Account Codes

System Availability

Standard on Strata DK14/DK40i/DK424

Account Codes are 4~15 digits in length and are often used for cost allocation. The codes are printed on a Station Message Detail Recording (SMDR) printout with other call details, so that the customer can identify all calls associated with a specific account code.

Forced Account Codes can be required on selected CO lines, which forces the assigned stations to enter those account codes. Stations without the Forced Account Code feature can voluntarily enter account codes on any incoming or outgoing call over any CO line. While account codes can also be entered on incoming calls, the entry cannot be forced on these calls.

The Strata DK14, DK40i, and DK424 systems can have up to 300 Verifiable Account Codes which can be forced or voluntary. DK424 systems with RCTUE/F processors can have up to 500 Verifiable Account Codes.

Stations and CO lines can have one of four possible account code features:

- ♦ Forced Account Codes
- ♦ Voluntary Account Codes
- ♦ Forced Verifiable Account Codes
- ♦ Voluntary Verifiable Account Codes

If Verifiable Account Codes are forced, the Strata DK system verifies the code entered by the user before it authorizes the call.

Verifiable Account Codes can be set up in two ways:

- ♦ All digits in the code can be verified. With this method, 300 (or 500 with RCTUE/F) specific account codes can be verified. For example, if a 4-digit code is used, the system can verify 300 specific 4-digit numbers. If a 9-digit code is used, the system can verify 300 specific 9-digit numbers.
- ♦ The first “portion” of the code can be verified. This enables 300 specific verifiable “prefixes,” which can then enable thousands of “partially” Verifiable Account Codes. For example, with a 5-digit code, there could be 300 verifiable 3-digit prefixes:

100 __, which verifies 10000, 10001, 10002, ... 10099 (100 codes)

101 __, which verifies 10100, 10101, 10102, ... 10199 (100 codes)

102 __, which verifies 10200, 10201, 10202, ... 10299 (100 codes)

•
•
•

299 __, which verifies 29900, 29901, 29902, ... 29999 (100 codes)

Each of the 300 verifiable prefixes partially verifies 100 codes, for a total of 30,000 partially verifiable codes. This is an important capability to ensure valid accounts are being used while allowing freedom to use sub-accounts for specific allocation of the call.

A Verifiable Account Code can have a toll restriction class of service. When an account code is entered at a station, the system checks the toll restriction class of service associated with that account code, and then determines if the call is authorized.

The Account Code button can be programmed on an electronic or digital telephone to facilitate voluntary account code entry during conversations without interrupting the talk path. It can also be used to enter Verified Account Codes to enable normally restricted stations to dial long distance calls.

Note The 911 emergency number and two other optional customer-designed numbers (up to four digits long) can be assigned to bypass Forced Verified Account Code requirements.

Benefits

Account Codes control costs and ensure accurate billing to departments, clients, projects, or individual employees. The advantage of using Account Codes for this purpose is that they register on SMDR for tracking and reporting.

Forced and verified account codes can also be used in conjunction with Toll Restriction. Used this way, they function as override codes or as traveling class of service codes.

Alarm Sensor

System Availability

Optional on Strata DK14/DK40i/DK424

Requirements

PIOU and PIOUS interface units are optional on the DK40i/DK424

DDCB, Door Phone Control Box, can be added to the DK14

The Alarm Sensor is configured with a customer-supplied alarm. When the sensor detects that the alarm relay is activated, it causes all telephones to sound an alert tone. Any station programmed with the Alarm button (alarm reset) can reset the alarm on a Strata DK system.

Benefits

Conveniently controlled with an electronic telephone, so that you can have an alarm indication wherever telephones are located. The source of the alarm is controlled from the device creating the alarm indication.

Alternate Answer Point

System Availability
Standard on Strata DK14/DK40i/DK424

Alternate Answer Point enables you to answer transferred CO line calls from any station that shares the CO Line button appearance or secondary DN for the destination station.

Benefits

Ideal for employees who have high mobility and promotes efficiency and better service to callers. It can also minimize the distraction caused by unanswered ringing phones.

Amplified Conference

System Availability

Standard on Strata DK40i/DK424

Unavailable on DK14

One or more customer-provided automatic gain, switched, two-way line amplifiers can be connected to proprietary station ports in the system. The amplifiers are automatically activated whenever a user conferences two CO lines together. Up to two amplifiers can be connected on the DK40i and up to four amplifiers on DK424 systems.

With Strata DK systems using Amplified Conference, there is negligible loss through the system, and the amplifier compensates for loss in volume over the public network. Any customer-supplied, two-way line amplifier that is FCC registered with Automatic Gain Control (AGC) should be compatible. The Reliance Electric model VFR 5050 has been successfully used.

The amplifier increases signal strength between any two outside CO lines. If Tandem, Call-Forward External, or Direct Inward System Access (DISA) CO line connections are provided in the system, the CO line-to-CO line connection is amplified.

Amplified connections are available on a first-come, first-served basis. On Strata DK systems, amplified conference is available to a standard telephone as well as digital or electronic telephones.

Each amplifier requires two EKT station ports, and reduces the station capacity by two. The two ports supporting the amplifier must be designated ports on a PEKU card. One PEKU supports one external amplifier.

Benefits

Enables the external parties of a conference call to hear each other. Conference calls are shorter and more efficient, since time is not wasted repeating inaudible parts of the conversation. Shorter calls are cheaper calls. When conferees can hear clearly, they get accurate information.

Auto Attendant

System Availability

Optional on Strata DK14/DK40i/DK424

Requirements

QKYS (DK14), KKYS (DK40i), and
RKYS1~4 (DK424) PCBs

Not supported by Tie, DID, DNIS, or ANI
lines for any applications including ACD

Standard station ports for announcers

DTMF receivers for simultaneous answering

Ground and loop start lines

The built-in Auto Attendant feature acts as a round-the-clock attendant that automatically directs incoming calls to stations. Calls can be answered simultaneously depending upon the number of DTMF tone receivers are installed in the system (maximum of 3 in DK14, 5 in DK40i, and 24 in DK424).

Callers who dial into assigned Auto Attendant lines receive a menu of dialing prompts, such as, “Dial 5 for Sales or dial 6 for Technical Support.” When the caller dials the digit, the call routes to a DN, ACD group, or Distributed Hunt group (assigned in system programming).

An unlimited number of CO lines can be programmed for immediate answer or delayed ring, such as 12 or 24 seconds, at selected stations. Auto Attendant also enables access to outgoing lines by using DISA, which should be security protected with Account Codes and/or a DISA security code.

CO lines that are assigned as Auto Attendant lines, in any of the system’s three time of day modes (Day, Day 2, Night), can be assigned to ring stations or a night bell when the system is switched to another mode. This enables calls to be manually answered until the Attendant requests the Auto Attendant to answer all new calls.

Customer-provided digital announcement devices and optional QRCU3 (DK14), K5RCU (DK40i) or RRCS (DK424) tone receiver PCBs are required. Multiple callers can be connected to one digital announcer simultaneously as follows:

- ♦ DK14 enables up to three caller connections
- ♦ DK40i enables up to five caller connections
- ♦ DK424 enables up to 24 caller connections

One DTMF receiver is needed for each caller.

The Auto Attendant can be programmed to answer on a delayed ring basis, which can be used for overflow and secondary answering purposes. This enables callers to hear Music-on-Hold (MOH) or Ring Back Tone (program option) after dialing a selection.

The system can have a primary announcement only, or a primary and secondary announcement. The primary announcement is the initial greeting played to the caller usually providing dialing instructions. The secondary announcement is automatically played if the selected station is not available.

From one to four primary announcers can be configured on a DK40i or DK424 system and one or two on a DK14 system. Light or normal incoming call traffic and/or short announcements can be handled by one or two announcers, while up to four can satisfy the demands of heavy traffic applications and/or long announcements.

The DK424 can have one to four primary announcers and zero to four secondary announcers. The DK40i can have a maximum of four announcers, and for the DK14, two announcers are maximum.

Each announcement is stored on a customer-supplied digital announcer connected to a standard telephone station port.

Callers who are directed to a station that is busy or does not answer are routed to:

- ♦ One secondary announcement which could inform the caller that the destination is unavailable and repeat the menu.
- ♦ The original announcement to hear the greeting and menu repeated.
- ♦ Ring designated alternate stations.

Unanswered calls ring the final destination station until either:

- ♦ A disconnect signal is received from the CO
 - ...or, the call is disconnected by an optional Strata DK call timer
 - ...or, the call is call forwarded.

If using loop start CO lines, reliable automatic release from hold must be available from the CO. Ground start lines are preferred, because of better disconnect supervision. With T1, ground-start lines must be provided.

Benefits

Extremely flexible with a single-level dialing menu and can have as many as 10 selections, each of which can direct calls to specific stations, hunt groups, or ACD Groups (DK424 only). If the caller knows the extension number wanted, quick and direct access is achieved. With Auto Attendant, customers and employers are provided an option to specify how their calls are handled.

Twenty-four hour coverage means no need to worry about lunch and break coverage and provides after-hours coverage. Also, overflow call coverage during peak traffic periods are handled efficiently without requiring additional Attendants to answer calls.

Auto Attendant can process a larger volume of calls more quickly and efficiently than a live Attendant. This provides incoming callers better overall service.

Three modes of ringing (Day, Day 2, Night) can be assigned for flexible answering by the built-in Auto Attendant or the Attendant.

Automatic Hold Recall

System Availability
Standard on Strata DK14/DK40i/DK424

When a station user puts a call on hold, the call automatically rings back to that station after a programmable period of time. Hold recall time is normally set at 32 seconds, but can be programmed from 11 to 160 seconds.

Benefits

Ensures that station users pick up calls that have been put on hold in a timely manner. Courteous customer service dictates acknowledging the caller periodically and informing them about delays. This feature can help a company project a professional, efficient, and courteous image.

Automatic Number Identification (ANI)

System Availability

Unavailable on DK14
Optional on Strata DK40i with K5RCU and DK424 with RRCS

ANI displays the telephone number of the calling party on the LCD of a ringing telephone, Attendant Console display, and/or sends it to an application computer or voice mail. The information is displayed on direct incoming, transferred, and call-forwarded calls. The ANI information continues with the call as many times as the active call is forwarded or transferred within the system.

The system supports ANI on analog or digital (T1) DID and Tie lines and provides helpful call identification information to answering parties. A typical ANI display example is shown at the right.

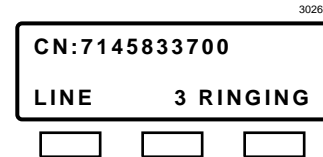

ANI is usually associated with “1-800” type calls offered by various long distance carriers (except AT&T) through T1 facilities. However, the Strata DK also provides ANI information received over analog DID and Tie line circuits. Either Sprint or MCI ANI format is supported.

ANI data is routed to DNs, Distributed Hunt Groups, ACD groups, voice mail devices, and external network numbers through external-call routing. ANI data on answered calls can be displayed on SMDR reports. ANI numbers can be routed to different destinations during Day, Day 2, or Night mode.

ANI digits can be received independently or simultaneously with Dialed Number Identification Service (DNIS) called number digits. When received with DNIS digits, calls can be routed to unique destinations for each DNIS number (see [Table 6](#) on [Page 25](#)). When ANI is received without DNIS, all ANI calls ring the same selected destination.

Important! ANI is unavailable on Strata DK14 systems.

Abandoned Call Numbers

ANI data is stored in system memory for calls that ring, but are abandoned before being answered so users see the telephone number of who called, even if the caller did not leave a message. LCD telephone and Attendant Console users can display and Auto Dial the “abandoned call” ANI numbers.

The DK424 system stores up to 2,000 ANI abandoned calls with the RCTUE/F processor, up to 1000 on RCTUC/D, up to 400 on RCTUBA/BB, and up to 200 on RCTUA. DK14 and DK40i can store up to 200 ANI abandoned call numbers. Individual stations can be programmed to store from 0 to 100 of the total ANI abandoned calls in increments of 10. A typical ANI abandoned call display is shown at the right.

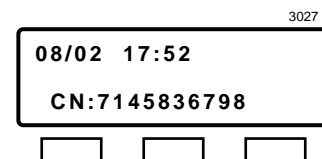

Table 6 ANI, Caller ID, and DNIS Routing Destinations

Routing Destination	ANI Line Calls	Caller ID Line Calls	DNIS Line Calls ^{1,2}	Tie & DID Line Calls ²	Ground ² / Loop Start Line Calls
Individual Primary/Secondary/Phantom Directory Number	X	X	X	X	X
CO Line or pooled line buttons		X			X
Individual Distributed Hunt (DH) Group ²	X	X	X	X	X
Individual Automatic Call Distribution (ACD) Groups	X	X	X	X	X
Remote Maintenance/Administration (M&A) Modem	X	X	X	X	X
System external Page (Tie lines, private network lines only)				X	
System night bell or night ringing over external Page	X	X	X	X	X
Intercept destination (station console announcement) applies to DID line types only	X		X	X	
External telephone network numbers	X	X	X	X	X
Voice mail box/Auto Attendant device	X	X	X	X	X

1. DNIS calls can be received independently or simultaneously with ANI “calling number” digits.
2. Not supported by DK14.

Computer Applications

For computer applications, ANI digits are sent to an individual PC connected using an Integrated PC Data Interface Unit (RPCI-DI). It enables pop-up screens on the PC that provide information regarding the calling/called party before answering and during the call.

Benefits

Provides instant information about the person calling to the station user and expedites call handling by shortening the length of the telephone call. Most of the information that the caller would have to provide is already available to the call taker.

Abandoned call information is available so station users know the telephone number and time/date of the last call, even if the caller hung up without leaving a message. This provides better service to callers and is a big productivity boost to call takers.

Automatic Release From Hold

System Availability

Standard on Strata DK14/DK40i/DK424

If an outside caller on hold hangs up, the system automatically disconnects the call and frees the line for other calls. This feature applies to DISA, DNIS and/or ANI external routed calls, Auto Attendant, and voice mail calls, as well as regular voice calls.

Automatic Release is available on a line-by-line basis, while on hold only or at all times, and operates only with COs that provide a disconnect (calling party control) signal.

This feature is designed to work with loop start CO lines and is not available on T1 lines.

Benefits

Provides full use of all CO lines at all times. A CO line is not tied up if a station user puts the line on hold and the caller hangs up before the station user returns to the call.

This is very useful for disconnect supervision in voice mail and built-in Auto Attendant applications, but availability and reliability of the signaling from the CO must be confirmed.

Background Music (BGM) Interface

System Availability

Standard on Strata DK14/DK40i/DK424

A BGM/Music-on-Hold (MOH) RCA jack is built into the common control unit on DK14, DK40i, and DK424 systems and connects a customer-supplied music source to the system. The music source or sources is flexible, providing one music source for telephone and external speakers or a separate source for each.

When BGM is broadcast over digital or electronic telephone speakers, no optional hardware is required. The customer-supplied music source for both background music on telephone speakers and MOH connects directly to the common control unit.

To connect BGM (separate music source) over telephone speakers, a station port should be assigned. The required interfaces cards are:

- ♦ DK14 – QSTU
- ♦ DK40i – KSTU, RSTU, PSTU, PEKU, or PESU
- ♦ DK424 – RSTU, RDSU, PSTU, PEKU, or PESU

When a music source is connected and this feature is activated, a station user can access BGM through the speaker of a digital or electronic telephone. The music is turned on and off at the user's option using the BGM button or a dial access code. The user can also control the volume.

On DK40i and DK424 systems, up to three separate music sources can be connected to the system at the same time. One source can broadcast BGM over digital or electronic telephone speakers, the second broadcasts over external speakers, and the third provides music or a recording for MOH. DK14 systems can support two separate music sources, one for MOH, and the other shared by DKT and external speakers.

When the source input for BGM over external speakers is unamplified, a DK40i or DK424 system can use the built-in, three-watt amplifier of an Option Interface Unit (PIOU or PEPU). Amplified music output requires the PIOU or PEPU, or the music input source must be connected through an external amplifier.

If an external paging system is installed, music can also be broadcast through the external paging speakers, providing background music throughout the facility. Music on both the external speaker and the telephones is muted when a paging announcement is made or when night ringing occurs.

Note There is an optional secondary interface.

Benefits

Provides music that is conducive to the work environment and enable employees to listen without the conflict that can accompany the use of radios or tape recorders.

Caller Identification (ID)

System Availability

Optional on Strata DK14/DK40i/DK424

Requirements

Caller ID/ground or loop start CO line PCBs

DK14 – WSIU PCB

DK40i – TCIU2, RCIU2 and RCIS PCBs

DK424 – RCIU2 and RCIS PCBs

On the DK14 system, the WSIU PCB provides an RS-232 interface to a customer-provided Caller ID interface device (TC-1041). CO lines that receive Caller ID must be cross connected to the TC-1041 (MLX-41) Caller ID interface box. The TC-1041 is available from TEL-CONTROL, Inc., P.O. Box 4087, Huntsville, AL 35815-4087, (205) 881-4000.

On the DK40i, the TCIU2, RCIU2 and RCIS PCBs provides four Caller ID circuits each. The TCIU2 is used for base cabinet lines and the RCIU2/RCIS is used for expansion cabinet lines to provide up to eight Caller ID interface circuits. A TCIU2/RCIU2/RCIS circuit must be available for each line that is to receive Caller ID.

On the DK424, the RCIU2 provides four Caller ID circuits when installed at the factory; however, an RCIS piggyback PCB can be installed on the RCIU2 to provide four more Caller ID circuits, for a maximum of eight Caller ID circuits per cabinet slot. An RCIU2/RCIS circuit must be available for each line that is to receive Caller ID.

The telephone number or name of the calling party can be displayed on the LCD of a ringing telephone, Attendant Console display, and/or sent to an application computer or voice mail. The information is displayed on direct, incoming, transferred, and forwarded calls. The Caller ID information continues with the call as many times as the active call is forwarded or transferred within the system.

A maximum of 10 telephone number digits can be displayed or sent to a computer, and a maximum of 16 characters for the name. A typical Caller ID display with soft keys off is shown below:

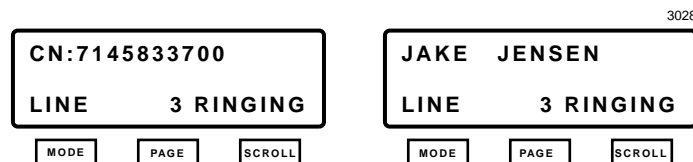

If both the name and number of the caller are sent by the COs, the name, rather than number, appears on the top line of the LCD display. The name and number do not appear together on the same LCD display. However, while the call is ringing, the user can press the Page button to toggle the top line display from name to number and back. This enables the station user to see both the name and number of the caller while the telephone is ringing. If the Caller ID feature is being used in conjunction with a CTI application, both the name and number are sent to the TAPI application computer.

Caller ID, on ground or loop start lines, provides similar capabilities as ANI. However, Caller ID in addition to the telephone number, can also provide the name of the caller, (if provided by the local CO). Caller ID is a feature offered by local COs on ground or loop start lines, whereas, ANI is delivered by long distance providers on digital (T1) or analog DID and Tie lines.

Note Caller ID is not available on analog DID, Tie, or digital T1 lines.

Caller ID data is routed to DN, Distributed Hunt groups, ACD groups (DK424 only), voice mail devices, and external network numbers through External Call Forward for private lines only. Caller ID data on answered calls can be displayed on SMDR reports and routed to different destinations during Day, Day 2, or Night mode.

Abandoned Call Numbers

Caller ID data is stored in system memory for calls that ring, but are abandoned before being answered. This gives the user the name (if provided by the local CO) and telephone number of caller, even if the caller did not leave a message. LCD telephone and Attendant Console users can display and Auto Dial the “abandoned call” numbers.

The DK424 system stores up to 2,000 abandoned calls with the RCTUE/F processor, up to 1000 on RCTUC/D, up to 400 on RCTUBA/BB, and up to 200 on RCTUA3. DK14 and DK40i can store up to 200 abandoned call numbers. Individual stations can be programmed to store from 0 to 100 of the total abandoned calls in increments of 10. A typical abandoned call display is shown below:

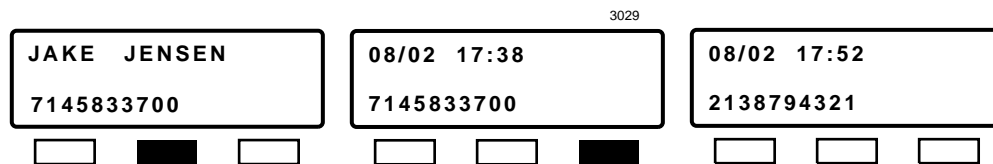

Computer Applications

For computer applications, Caller ID digits are sent to an individual PC using an Integrated PC Data Interface Unit (RPCI-DI). On DK424 ACD applications, the digits can also be sent to ACD agents using a LAN computer with system open architecture if it has the Serial Interface Unit (RSIU). It enables pop-up screens on the PC that provide information regarding the calling/called party before answering and during the call. System open architecture requires Release 3.2 or higher DK424 software.

Benefits

Provides instant information about the calling person. It expedites call handling by shortening the length of the phone call. Most of the information that the caller has to provide is already available to the call taker. Even abandoned call information is available, so station users know the phone number, even if the caller hung up without leaving a message. This provides better service to callers and is a big productivity boost to call takers.

Centrex/PBX Compatibility

System Availability

Standard on Strata DK14/DK40i/DK424

Any Strata DK system can be installed behind a Centrex or PBX system. It can function as part of the Centrex or PBX system while providing its users with the Strata DK features and digital feature telephones.

To further enhance Strata DK compatibility with Centrex and PBX, access codes for features in the host system can be programmed as if they were system Speed Dial numbers. These codes can then be assigned to the Speed Dial button, also known as station Automatic Dialing buttons, providing one-button access to the CO, Centrex or PBX feature. Each CO/Centrex/PBX feature access code can have up to 20 digits, including pauses and flashes.

When a Strata DK system is installed behind a PBX, some or all of the CO/PBX line buttons function like PBX extensions. When such a PBX line button is accessed, the station user receives PBX dial tone, not CO dial tone. To access a CO line on the PBX, the user must dial an access code. For example, “9” might be dialed to get a local CO line; Tie lines to other company locations might be accessed by “72” or “73.”

A Strata DK system can be programmed to recognize these PBX access codes or disregard them on identified lines when it inspects dialed numbers for toll restriction purposes or performs other features such as Last Number Redial. This enables the system to continue to provide its features, even when calls are ultimately going out from the PBX.

Benefits

Increased cost savings to the customer because the economical Strata DK systems can be used in satellite locations. Users can take advantage of the Centrex and/or PBX features, the PBX trunking, and the PBX networking capabilities.

Strata DK systems can also be used within a PBX environment to serve a community of interest which needs the functionality of electronic telephone sets that may not be provided by the PBX.

Also, CO/Centrex/PBX feature buttons give users easy, one-button access to features that would otherwise require more complicated access procedures. Since users do not have to look up feature access codes, this saves time. Time wasting dialing errors can also be eliminated through the use of feature buttons.

Centrex Ringing Repeat

System Availability
Standard on Strata DK14/DK40i/DK424

Strata DK systems can be programmed to reproduce Centrex or PBX ringing patterns, enabling the user to differentiate between station or CO line calls and various callback features on the Centrex or PBX line.

Benefits

Enables the user to hear the same on/off ringing patterns that are heard for special calling and callback features on CO, Centrex, or PBX lines. Users do not have to learn new ringing cadences and can easily differentiate between station or CO line calls or various callback features on the Centrex or PBX line.

Computer Telephony Integration (CTI)

System Availability

Optional on Strata DK14/DK40i/DK424

CTI combines the capabilities of the Strata DK digital business telephone system with custom functionality provided by computer applications. This is provided through digital telephone integrated PC interface. The PC must be running Microsoft Windows software.

Digital Telephone Integrated PC Interface

Toshiba 2000-series digital telephone can be connected to a PC, enabling routine simultaneous voice and data switching applications and more robust CTI applications. The connection is made with an RS-232 cable from a communication port on a PC to an RS-232 port on the digital telephone.

The RS-232 port is provided by equipping the digital telephone with an integrated Personal Computer Interface Unit (RPCI-DI). This is an optional unit that replaces the normal telephone base.

Data switching applications enable users to make data calls to printers, PCs, and other data devices. Users can also make voice calls using PC directory dialing software without the need of a modem or an extra outgoing line. The system can also be programmed with one to four security groups and can restrict calls between groups. It can also support modem pooling and printer sharing.

For CTI applications, digital telephones can be connected to a computer with application software using the TAPI to provide customized functionality. Any TAPI enabled PC software is compatible with Strata DK systems. The most common use of this application is a database look up and pop-up screens that contain calling party information. Caller ID, ANI, DNIS, and call-processing information is passed from the digital telephone to the application computer, providing information necessary for the look-up and pop-up screens.

StrataLink

The Strata DK can interface with computer applications that conform to Windows TAPI format. The Toshiba StrataLink Telephone Service Provider Interface (TSPI) software enables the Strata DK to communicate with TAPI applications. It is bundled with the RPCI-DI on a 3.5 inch, IBM-compatible, floppy disk.

StrataLink software greatly enhances the use of the basic TAPI interface. It enables you to customize the call-control functions of your PC application with many value-added capabilities, such as:

- ♦ Selecting how the PC application responds to the next call event.

StrataLink accepts call events from the telephone, applies call handling rules and conditions, and causes resulting actions to take place in the PC application. You choose the rules and conditions to customize how your application works.

- ♦ Handling multiple telephone calls

Most TAPI compatible applications only respond to a ringing line for Caller ID database look up and screen display so only one call is handled at a time. StrataLink enables the application to respond to multiple calls and events that capture calls and when reconnecting to a held call. You can delay the screen display while on another call or for a programmed amount of time.

- ✦ Handling multiple PC applications from the same telephone. Incoming calls can activate actions in different applications depending upon the type of call. For example, you can:
 - ✦ Generate a “customer database” application display of callers on your regular DNs
 - ✦ Use “help desk” application software generated from ACD calls
 - ✦ Beep your pager with Caller ID when you are away from your desk
 - ✦ Assign different applications to work on specific buttons on your telephone, or on all buttons

- ✦ Enhancing outbound calling

StrataLink provides for outbound telephone calling and call control from the PC application.

- ✦ Setting up, testing, and monitoring are easy

StrataLink provides tools for testing the interface, debugging or monitoring the call events, and setting up. Simply select from predefined tested applications and the proper interface is automatically assigned.

Figure 1 is an example of the TAPI interface that connects the digital telephone to the PC in a desktop integration application example. This is used when the database information resides in the individual PC.

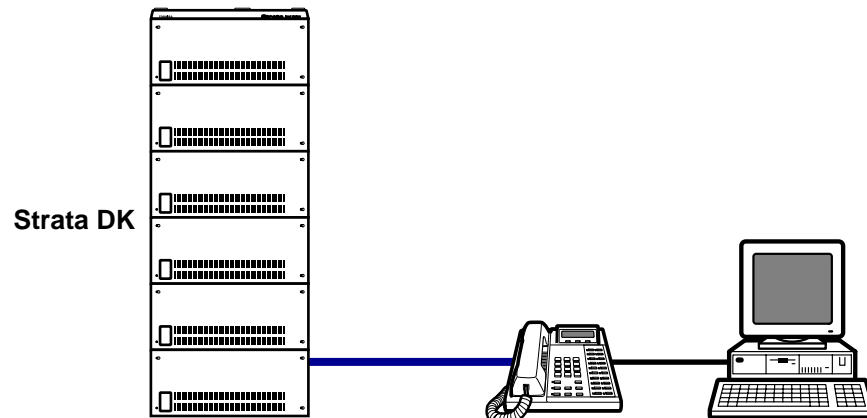

Figure 1 PC and Digital Telephone TAPI Interface Connection

Figure 2 is an example of the TAPI interface that connects the digital telephone to the PC and the PC to the LAN server in a LAN application. This is used when the database information resides in the server.

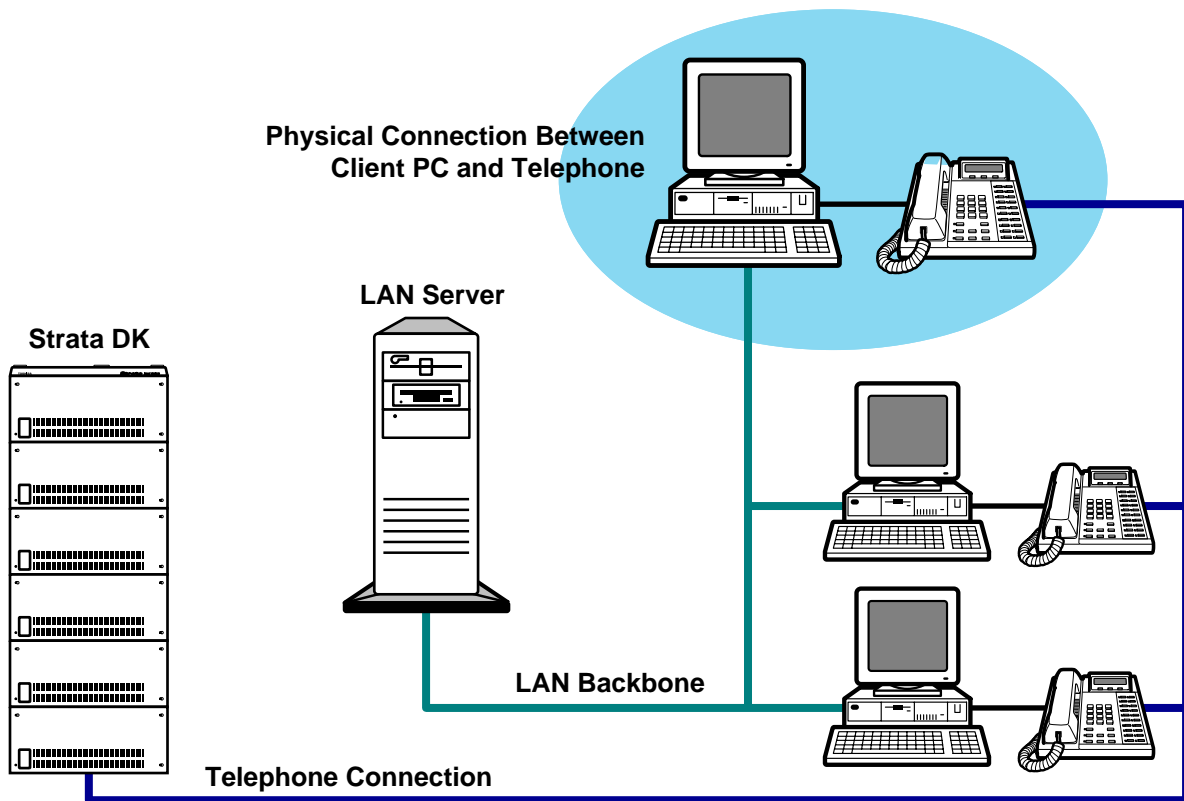

Figure 2 CTI Interface Connection

Benefits

Provides custom functionality for business telephone systems by combining the two technologies. Users gain functionality that cannot be provided by the telephone or the computer by themselves. Simultaneous voice and data transmission over a single-wire pair eliminates additional wiring requirements and minimizes port usage on the system. For example, modem pooling and printer sharing enables multiple users to maximize efficient usage of expensive peripheral devices.

PC keyboard dialing of data or voice calls increases user efficiency. Auto dialing by name from directories stored in PCs equipped with inexpensive desk organizer-type software (modem not required) is an example. Data security groups control who is authorized to make outside data calls, which can get expensive if linked to databases which charge for access.

Conferencing

System Availability

Standard on Strata DK14/DK40i/DK424

Conferencing enables other people to join your conversation. These additional people can be inside or outside the DK system. Any digital or standard telephone can set up conferencing with other digital or standard telephones. The following combinations are available:

- ◆ One or two stations and two outside lines
- ◆ Two or three stations and one outside line
- ◆ Four stations on one internal DN line
- ◆ Voice mail plus one station and two other internal or outside line parties (DK424 only)

Note Amplified conference is available on DK40i and DK424 systems, but unavailable on the DK14.

System-wide programming enables or disables Conferencing. The number of simultaneous conferences are:

System	Four-party	Three-party
DK14	2	2
DK40i	3	4
DK424 RCTUA	3	4
DK424 RCTUBA/BB	7	10
DK424 RCTUC/D	7	10
DK424 RCTUE/F	14	20

On DK40i and DK424 systems, the CO line conference can be amplified with a customer-supplied two-way amplifier to improve the negligible loss encountered through the system over the public network (see [“Amplified Conference”](#) for details).

The basic application of this feature enables a station user to call voice mail during a conference call and play messages to all parties in the conference. The DTMF tones can be sent from any DK424 station in the conference.

Benefits

Provides a convenience to business, because everyone participating in the conference gets the same information at the same time reducing confusion and saving time.

Credit Card Calling (“0+” Dialing)

System Availability

Standard on Strata DK14/DK40i/DK424

Callers can make “0+” telephone credit card calls from selected toll restricted stations. Calls are billed to the credit card instead of the Strata DK CO line. The “0+” credit card calling feature can be selectively assigned to stations and CO lines.

If a toll restricted station has the credit card calling feature, the Strata DK system requires the user to enter a certain number (programmable) of digits after dialing “0” on a CO line that has the feature. If the caller does not enter that number of digits within 20 seconds after dialing “0”, the call is dropped.

If the system has LCR, a station that has the feature can place a “0+” credit card call on any CO line accessed by LCR.

Benefits

Provides the convenience of “0+” telephone credit card calling without compromising toll restriction.

Delayed Ringing

System Availability

Standard on Strata DK14/DK40i/DK424

A ringing delay of 12 or 24 seconds can be programmed for each CO line that rings at a given station. For example, an incoming CO line can be programmed to ring at one station (or a group of stations) immediately when the call comes in, and at a second station (or group of stations) 12 or 24 seconds later. It can be applied to ringing assignments for Day 1, Day 2, and Night ringing modes. See [“Night Transfer \(Day/Night Modes\)”](#) for more information.

The Auto Attendant can be programmed to answer CO lines, either 12 or 24 seconds after stations have been ringing. In this case, the telephones that initially ring, stop ringing when the Auto Attendant answers.

For multiple DNs, the same capability as above exists for ground or loop start CO lines. For internal, DID or Tie line calls, a different delayed ringing controlled by different system programs is available. This means that secondary DNs can ring delayed after the PDN or PhDN. Or, the SDN can ring first, followed by delayed ringing of 12 or 24 seconds at the PDN or PhDN.

Benefits

Improves call handling and call coverage by providing one or more alternate answering positions for any incoming CO line or DN appearances. Calls have a greater chance of being answered promptly.

Because of the delay in ringing, employees at alternate answering stations are not disturbed by ringing while they wait to see if the called station answers. If the line rings at their station, they know they should answer it. Delayed ringing on multiple DNs is perfect for “Boss/Secretary” call coverage.

Dialed Number Identification Service (DNIS)

System Availability

Unavailable on Strata DK14
Standard for dial pulse DNIS
Optional on DK40i/DK424 with DTMF DNIS

Requirements

Typically requires DTMF receivers

DNIS identifies the called number and displays it on the LCDs of ringing telephones. The DK424 compares the received digits (DNIS tag) to a program table that determines how to route the call and what display to provide. A 16-character alpha/numeric identifier is displayed on the ringing telephone's LCD or Attendant Console display.

DNIS digits can also be sent to an application computer. DNIS names are stored within the Strata DK as defined by the user and programmed into Strata DK system programming. The names display on direct, incoming, transferred, and call forwarded calls. This enables calls to be answered appropriately by type of call. A DNIS display is shown below:



Figure 3 shows a sample overview of the call flow provided by the Strata DK DNIS capability.

DNIS is supported on digital T1 or analog DID and Tie lines. DNIS is typically used with “1-800” type of calls using long distance carriers over T1, but can also be provided over analog DID and Tie line circuits.

It is important to note that the Strata DK DNIS feature can treat all incoming local DID and Tie line calls the same. It can treat them as incoming DNIS long distance 1-800 calls for the purpose of routing these calls through the DNIS tables in the Strata DK. This is what makes DNIS such a flexible feature.

DNIS enables multiple numbers to ring into the same line or line group, providing optimum trunk usage as well as helpful called number/name identification information. This provides much more efficient usage of lines than the traditional usage of 800 numbers. Traditionally, each 800 number was assigned to its own line group, often resulting in a large number of under-used lines. The Strata DK DNIS capability solves this problem by using each DNIS line on an as-needed basis for different 800 number calls.

DNIS data is routed to DNs that can have multiple appearances, Distributed Hunt groups, ACD groups (DK424 only), and external network numbers through external call routing. DNIS digits can be received independently or simultaneously with ANI digits.

Each DNIS number can have its own voice mail ID code and can be routed to different destinations during Day/Day2/Night mode.

The DK424 supports 500, 350, 200 DNIS numbers and 300, 200, 100 telephone network numbers for the RCTUE/F, RCTUC/D, RCTUBA/BB, RCTUA, respectively. The DK40i supports 200.

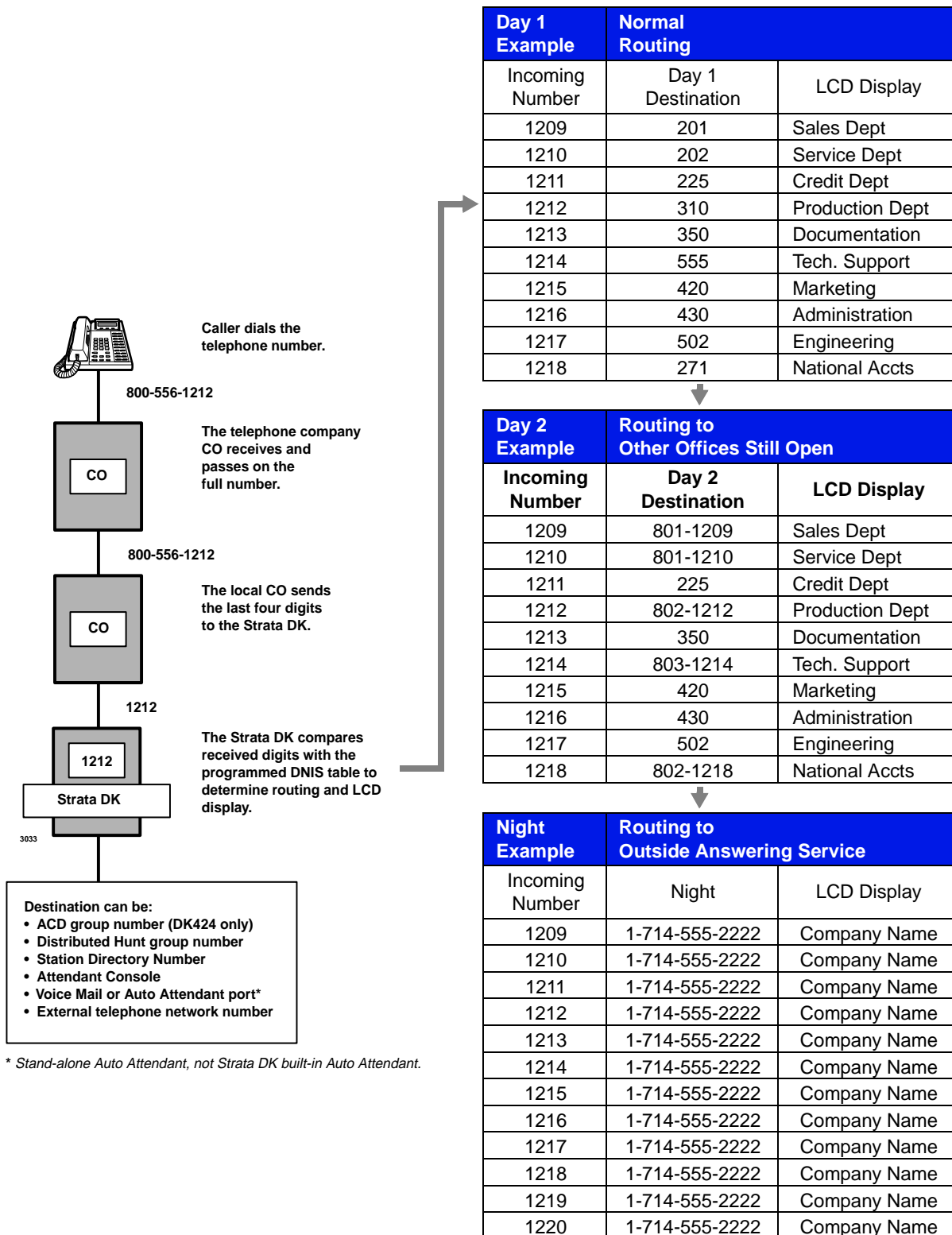

Figure 3 DNIS Examples

External Telephone Network Numbers

All DNIS/DID/Tie numbers that ring into the Strata DK can be routed externally to any outside telephone number. Depending on the application, the caller DNIS name may be passed to the destination Strata DK when routed over the user's end-to-end telephone network.

Voice Mail

If assigned in the system database, incoming calls for each unique DNIS/DID/Tie number can be directly routed or call forwarded to a designated voice mailbox. This enables callers of each DNIS/DID/Tie number to receive immediate, personal custom greetings. This feature is available using in-band integration, but not available using SMDI.

Benefits

Enables the easy answering of calls appropriate to the type of call with the helpful call identification information. For example, this is very helpful for answering services, executive suites, or multiple product line sales applications. Also, optimum trunk usage saves money by providing the same level of service with fewer "1-800" type lines.

Direct Inward Dialing (DID)

System Availability

Unavailable on DK14
Optional on DK40i/DK424

Requirements

Typically requires DTMF tone receivers

DID enables incoming calls to ring a specific DN, or any number of stations which share a common DN, without going through the answering position. Calls over a single DID line can reach any one of a number of stations, ACD groups, or Distributed Hunt groups, depending upon the last four digits of the telephone number dialed. DID lines can use DNIS programs to provide DID with all DNIS features.

Each DID line has a single office code and a block of extension numbers that can individually ring stations as assigned in system programming. DID lines can directly access the remote maintenance modem, but not the Strata DK built-in Auto Attendant.

DID lines can optionally provide automatic camp-on busy when callers dial a busy station on incoming DID calls. This feature provides a camp-on tone and distinctive LED flash at the busy station.

If a second DID call is received at a busy station that has only one PDN button, the station user hears muted camp-on tone, and the second call camps-on (assuming camp-on has been turned on). If camp-on is off, the second caller hears busy tone unless forwarded to another station.

If a second DID call is received at a busy station that has more than one primary PDN button, the station user has the option of hearing muted camp-on tone and the second call camp-on, or the second call rings continuously on the other PDN button. This enables the station user to answer multiple calls to their DID number, including transferred calls. Two appearances of the PDN are recommended for this operation. Up to four PDN appearances may be used for some applications.

Outgoing calls can be made on two-way DID lines. However, ABR is not supported for those two-way lines. DID lines can be either DTMF or dial pulse signaling. Also note that a secondary protector is required for each DID circuit.

DID calls call forward externally if the station has Call-Forward External activated.

DID lines can be provided through analog circuits on the TDDU and RDDU interface or through digital circuits on the T1/DS-1 RDTU interface. An optional DTMF tone receiver (K5RCU or RRCS) is typically required for DID line DTMF operation.

Benefits

Provides efficient, direct calling to individual stations without going through the answer position and reduces the load on call answering positions. It also gives “private line” service to many individuals at a lower cost.

Direct Inward System Access (DISA)

System Availability

Optional on Strata DK14/DK40i/DK424

Requirements

DTMF tone receivers

Loop and ground start CO lines can be DISA programmed, but not DID and Tie lines

By calling in on a specific telephone number assigned to DISA, callers are connected directly to the Strata DK system and can dial internal stations or outgoing CO lines without going through the Attendant.

The caller dials the CO line number for DISA and hears two rings. Then a tone sounds for nine seconds, during which the caller dials a station number or the access code for a specific outgoing CO line or line group (“9” for LCR is not enabled). If the station or CO line is busy, the caller can dial another station or CO line. If no station number or CO line access code is dialed and the nine-second interval elapses, the call is transferred to a pre-assigned ringing arrangement (Day, Day2, or Night).

An optional DISA security code (1~15 digits) can be programmed and is highly recommended in all DISA applications. When the security code is programmed, the caller must enter it in order to make outgoing DISA calls on CO lines. The security code is not required to dial internal stations. Certain digital telephones selected in programming can revise the DISA security code.

A caller can also be required to enter a forced/verified account code (1~15 digits), along with the DISA security code, to access to an outgoing CO line through the system. This can be used as a secondary level of access security.

Strata DK systems can provide a DISA class of service to CO lines, which enables Toll Restriction to be applied to DISA CO line calls. For example, outgoing CO line calls could be restricted to local calls only when accessed through DISA. Any number of CO lines can be programmed with the DISA feature. CO lines can be programmed as normal lines during daytime operation and DISA lines at night.

The DISA feature can be accessed from the Strata DK built-in Auto Attendant by dialing “*” during the Auto Attendant greeting. Whenever using the DK built-in Auto Attendant, the system DISA security code should be used to prevent unauthorized calls through (into and out of) the Strata DK system.

Benefits

Saves money because employees can use the company’s calling network even when they are not in the office. Saves time because employees can call directly into the desired station without waiting for the Attendant to answer. Reduces the Attendant’s incoming call load and enhances service. Before and after hours, family members and others can use DISA to directly dial an employee’s station, improving the chances that the employee receives the call.

Distinctive CO Line/Internal Ringing

System Availability

Standard on Strata DK14/DK40i/ DK424

Incoming CO lines ring with a different ring cadence than do internal intercom/DN calls. Users can easily distinguish the type of call, even when the telephone is not in view. This feature works with digital, electronic, or standard telephones.

Benefits

Conveniently identifies the type of call ringing the station. The station user can answer with an appropriate greeting.

Door Lock Control

System Availability

Optional on Strata DK14/DK40i/DK424

Requirements

DDCB PCB

DK40i/DK424 can use PIOU, PIOUS, or PEPU

The Door Lock Control feature enables any telephone programmed with the Door Unlock button to unlock a door. Pressing the button activates the electronic door lock, and the lock opens for three to six seconds as specified in programming. The electronic door lock mechanism must be supplied by the customer. The number of locks each system supports is:

- ♦ DK14 – up to two locks
- ♦ DK40i – up to three locks
- ♦ DK424 – up to four locks with the RCTUA; all other processors support up to five locks

Benefits

Provides a great convenience by eliminating the need for extra equipment to remotely control the lock, or the need to physically get up and go to the door to open it.

Door Phone

System Availability

Optional on Strata DK14/DK40i/DK424 that require DDCB PCB

The optional door phone/monitor station is an external/remote two-way speaker box which has a direct voice link to a station. A door phone is frequently mounted near a building entrance and associated with a customer-provided door lock to help screen visitors. Pressing the button on a door phone sends a distinctive ringing only to idle digital or electronic stations which have been programmed to receive ringing from that door phone.

If all stations are busy, a muted ring is sent to the lowest numbered station programmed to ring. When a station answers, it is automatically connected to the door phone. Door phones can be programmed to ring over external page when the system is in Night mode.

A station can dial an individual door phone/monitor station and either converse with someone at the door phone, or simply monitor conversation or sound at the door phone. No warning tone is heard at the door phone/monitor station when it is called by a station.

Door phones are supported by the door phone/lock control box (DDCB) external module. One control box supports up to three door phones. The DDCB requires one DKT station circuit on a PDKU, RDSU, KCDU, or QCDU.

Door phones can be assigned to ring PDNs and/or PhDNs. The number of door phones in each system supports is:

- ♦ DK14 – up to six door phones
- ♦ DK40i – up to nine door phones
- ♦ DK424 – up to nine door phones with RCTUA, and up to twelve door phones with all other processors

Benefits

Increases building security and employee safety, especially after hours. It can also provide a “hot line” calling link between an office and such facilities as a warehouse or laboratory.

DTMF and Dial Pulse CO Line Compatible

System Availability

Standard on Strata DK14/DK40i/DK424

Signals generated by pressing the dial pad buttons of a digital telephone are neither DTMF nor rotary dial signals. The system can be programmed to translate these station signals to either DTMF or rotary dial signals as required by the serving CO.

Each line is programmed individually for DTMF or rotary dial signaling. If a CO line is rotary, a telephone or Attendant Console user can send DTMF tones as required, by pressing the Tone Dial Select button (flexible program option).

The system can be programmed to enable or prevent DTMF tones from being returned to digital telephones when a user dials on outside lines or sends DTMF digits to a voice mail device.

Benefits

Provides easy accommodation of both older, rotary CO and the newer touch-tone COs. In both cases, the station user can still have the convenience and aesthetic appeal of a push-button phone.

DTMF Signal Time Setting

System Availability

Standard on Strata DK14/DK40i/DK424

For Strata DK systems, the Speed Dial and voice mail integration DTMF signal time can be set independently at 80 or 160 ms in system programming for CO line dialing and for voice mail auto dial digits. The standard setting for CO line dialing is 80 ms. The standard setting for voice mail digits is 160 ms.

See also the station feature, “Continuous DTMF Signal Time.”

Benefits

Provides flexibility in meeting both the DTMF requirements of the serving CO and those of a voice mail device. As a result, a customer can have faster connection time to the public network and still accommodate voice mail systems.

E911 Enhanced Operation

System Availability

Optional on Strata DK14/DK40i/DK424

Requirements

DK14/DK40i/DK424 - adjunct equipment

DK424 - RMCU/RMCS PCB

Strata DK14, DK40i, and DK424 systems support Enhanced 911 (E911) emergency services. This feature uses special Centralized Automatic Message Accounting (CAMA) trunks to include the Caller's Emergency Service Identification (CESID) in the 911 call. The local carrier delivers the CESID to the Public Safety Answering Position (PSAP) which uses it to determine the exact location (building, floor, office number, etc.) from which the call is originating.

Notes

- Each station in the Strata DK may be programmed with a unique CESID. In some jurisdictions, the CESID must be a valid directory number that the PSAP can call back if disconnected. In many cases, this may require Direct Inward Dialing (DID).
- In order for the E911 feature to be effective, 911 calls and 9+911 calls must be dialed from a digital telephone DN or from a single line telephone. 911 calls originated from the CO Line button or the Pooled Line button bypass the adjunct equipment and go directly to the CO exactly as dialed.

Enhanced 911 is distinguished from conventional 911 by providing more precise information about the location from which the 911 call originates. A conventional 911 call is identified to the PSAP by the listed directory number of the organization providing the multi-line telephone systems. Emergency service workers cannot determine the precise location of the caller with conventional 911 and this results in services being misdirected, time wasted, potentially and lives lost. Enhanced 911 provides a unique CESID for each telephone using it to identify the location of the caller within a large, multi-floor building, multiple buildings within a campus type environment, or from an off-premise station that is terminated at a different address than the main telephone system.

The CESID is delivered to the PSAP by the local carrier. The PSAP then uses the CESID to interrogate an Automatic Location Identifier (ALI) database that returns precise location information. Once translated, this information becomes associated with the emergency call and can be shared with responding agencies such as police, ambulance, fire, etc.

Note In some jurisdictions, the business owner is responsible for maintaining accurate information in the ALI database. Since Automatic Set Relocation allows telephones to be relocated without the business owners knowledge, you may wish to turn Automatic Set Relocation off.

For complete information on E911, please see the National Emergency Number Association's home page at <http://www.nena.org>. The "911 Tutorial" at that address is particularly helpful.

Strata DK14 and DK40i systems support the E911 feature through a standard telephone port to an external, third party system. The third-party E911 adjunct system provides translation and signaling of the correct CESID location information to the 911 PSAP.

The Strata DK424 system supports the E911 enhanced locator service through either external adjunct equipment or the CAMA Trunk Interface Unit (RMCS). The RMCS is a special CO line card installed in a card slot. A system will support up to four trunks. Excess calls will route as standard 911 calls over local trunks.

The CAMA card solution provides internal notification. When a 911 call is connected to the PSAP, the Strata DK will ring designated stations and attendant consoles and present CESID information in the displays. When a notified station answers the call, a three-way conference is established between it, the calling party and the PSAP. The SMDR port generates two call records: one at the beginning of the call and one at its termination.

Note The FCC is in the process of defining national standards for E911 compatibility, but there is no official due date. At present both legal and technical requirements vary significantly by state and readers are advised to contact local emergency service providers and telephone companies for detailed requirements.

DK14 and DK40i Operation

Strata DK14 and DK40i systems support E911 operation by forwarding 911 calls and 9+911 calls to designated standard ports to interface with external, third-party, translation equipment. The systems provide up to two standard telephone ports for this purpose. The external interface connects a standard telephone port to a CAMA trunk and provides multi-frequency (MF) signaling and translates the DN from the Strata DK to CESID.

The interface between the third-party adjunct equipment and the E911 tandem CO must use special CAMA trunks. These specialized trunks are ordered through the special ordering desk of your local phone company.

DK424 Operation

In addition to the external solution, the Strata DK424 system supports the E911 service through the CAMA Trunk Interface Unit (RMCU/RMCS), a special CO line installed in a card slot. The CAMA Trunk Interface Unit (RMCU) supports two CAMA Trunk Subassemblies (RCMS) that support two CAMA trunks each. Software in the DK424 performs the CESID translation and signaling.

Adjunct Equipment Suppliers

Two companies have been identified that supply the E911 adjunct translation systems -Proctor and Associates, Redmond, WA (800) 824-9719; and Telident, Inc., Minneapolis, MN (800) 536-4911.

Information regarding the E911 adjunct interface equipment can be found in the Strata DK Installation and Maintenance Manual.

Benefits

Enables the Strata DK to conform to most regulatory environments. The agency responding to the 911 call gets location information that makes it easier for them to find the right location within the facility. This provides faster emergency service to those needing it.

External Amplified Speaker

System Availability

Optional on Strata DK14/DK40i/DK424

Requirements

HESB and HHEU or PIOU/PEPU (paging)

The External Amplified Speaker (HESB) is a six-inch, three-watt speaker with a three-watt amplifier built into a wooden speaker box. It can be used to:

- ♦ Amplify the ringing on a digital or electronic telephone.
- ♦ Provide a paging amplifier/speaker.
- ♦ Create an amplified talk-back speaker arrangement in an area where a telephone is not needed. The HESB is installed as a speaker and connected to a door phone unit that is used as the talk-back microphone.

The number of HESBs that can be installed per system depends on the function of the HESB. Any number of HESBs can provide loud ringing bells for electronic or digital telephones. Only one HESB can be installed if it is used as a paging or an amplified talk-back speaker.

Note Digital or electronic telephones, an HHEU2 interface, and an HESC-65A cable are required for each phone that has a loud ringing bell. A 2000-series digital telephone that has been upgraded with a data interface unit can be upgraded with the HHEU2 options but older telephone models cannot.

On DK40i and DK424 systems, the PIOU or PEPU Option Interface Unit is required when an HESB is used as a paging/amplifier speaker or an amplified talk-back speaker.

Benefits

Provides several options to make a communications system more efficient. A loud ringing bell can improve call handling in noisy areas where non-amplified ringing on a phone may not be heard.

A paging speaker ensures that paging announcements can be clearly heard throughout an area. In an area where a DKT is not needed, a talk-back speaker provides a cost-effective communications solution.

Flexible Button Assignment

System Availability

Standard on Strata DK14/DK40i/DK424

On both 10-button and 20-button telephones, one button is usually assigned to the Intercom/PDN function. In some cases, the Automatic Off-hook Selection feature is programmed to select the Intercom line, eliminating the need for an Intercom/DN button.

The other buttons can be assigned to a CO/PBX line or to certain features. Some possible assignments are:

- ♦ CO/PBX Line Button – If the telephone is being used in conjunction with a DSS console, all buttons could be used as CO/PBX buttons.
- ♦ Pooled Line Button – Enable a group of CO lines to appear under one button. Up to four Pooled Line buttons per CO line group can be assigned at each telephone. See “[Pooled CO Lines](#)” for more information.

[Table 7](#) lists the features that can be assigned to flexible buttons.

Table 7 Assignable Features

Feature Name		
Account Codes	Alarm Reset	Alert Signal
All Call Voice Page	Alphanumeric Messaging	Automatic Busy Redial
Automatic Callback (Internal Calls)	Background Music (BGM) Interface	Call Forward – All Calls
Call Forward – Busy	Call Forward – Busy/No Answer	Call Forward – External
Call Forward – Fixed	Call Forward – No Answer	Call Park
Call Park LCD Display	Call Park/Page	Call Pickup (Directed)
Call Pickup (Group)	Call Pickup 1~4 (Tenant 1~4)	Data Release
Caller Identification (ID)/ANI	Data	Do Not Disturb (DND)
Direct Station Selection (DSS)	Directory Numbers (PhDN, PDN, SDN)	Locked Automatic Dialing
Door Unlock 1~5	DTMF/Rotary Signal Selector (Tone Key)	LCD Message
Flash	Handset OCA	Lost Call Auto Dial
Modem	Night Transfer (Day/Night Modes) (Tenant 1~4)	Night Transfer Lock
Pause (1.5, 3, or 10 Seconds)	Pooled Line Group 1~16	Privacy
Privacy Release	Release	Released Answer
Redial Last Number	Saved Number Redial	Speed Dial Select
Speed Dial Pause and Long Pause	Station Speed Dial Codes	Tone (DTMF/Rotary Signal Selector)
Message Waiting for PhDNs	Microphone Cutoff	

There are several standard keystrip patterns that can be programmed to make button assignments easy. Buttons on individual stations can then be changed from the standard keystrip pattern selected for that station. Strata DK systems have four keystrip patterns from which to choose (A, B, C, and D).

Features

System Features

However, on 10-button and 20-button telephones, Flexible Button Assignment enables the programmer to define each of the buttons instead of choosing a standard keystrip pattern and then changing individual buttons. Any button which is not programmed for a specific feature or CO line is automatically assigned per the initialized pattern.

The use of the “Keyprint 2000” PC software package now makes custom keystrips easy to create and print.

Benefits

Flexible Button Assignment enables each phone to be customized to the particular needs of the station user. The system can be tailored to fit the business communication needs.

Flexible Intercom/DN Numbering

System Availability

Standard on Strata DK14/DK40i/DK424

Flexible Intercom/DN Numbering enables a station intercom or DN, including the numbers for the Attendant stations, to be any number from one to four digits long. The intercom/DN does not have to correspond to the fixed station location number in the Key Service Unit (KSU).

The maximum number of available unique station DNs (PDNs plus PhDNs) are listed below:

- ♦ DK14 - up to 20 unique station DNs are allowed
- ♦ DK40i - up to 56 unique station DNs are allowed
- ♦ DK424 - up to 672 unique station DNs are allowed

Single-digit DNs, such as “0”, can be assigned to Attendant Consoles or Attendant telephones.

Benefits

Enables a consistent numbering plan for and facilitate the efficient use of a business’ communications system when the system includes several different types of telephone systems. Branch offices which have Strata DK systems can have the same numbering plan as larger offices using PBXs.

In the case where a system is being used behind Centrex, intercom numbers/DN can match Centrex numbers.

If a Strata DK system is replacing a system that had a three- or four-digit numbering plan, the same plan can be used with the new system, eliminating the need for new directories and new extension numbers.

Finally, if the Strata DK system is being used with a voice mail system that has three- or four-digit mailbox numbers, the extension numbers can match the mailbox numbers.

Flexible Line Ringing Assignment

System Availability

Standard on Strata DK14/DK40i/DK424

Each incoming CO/PBX line that appears on a given station can be programmed to either ring or not ring at that station. Each CO/PBX line can be programmed to ring at any number of electronic/digital telephones. Thus, the number of ringing electronic/digital telephones per CO line is limited only by system size. In the DK424, a maximum of 120 phones can ring at one time.

Each CO line can be programmed to ring the Auto Attendant, night bell, DISA, remote maintenance modem or any station DN in the system. A different ringing assignment can be created for each of three ringing modes – Day, Day2 or Night. Also, stations assigned to ring can do so with any of the following timing designations.

◆ Immediate

Stations assigned Immediate timing ring as soon as the line rings into the system.

◆ Delay 1

If stations with Immediate timing have not answered within 12 seconds (3 rings), stations assigned Delay 1 timing also begin ringing. Immediate Ring telephones continue to ring when Delay 1 Ring telephones ring.

◆ Delay 2

If the above stations have not answered within 24 seconds (6 rings), stations assigned Delay 2 timing also begin ringing. Immediate and Delay 1 Ring telephones continue to ring when Delay 2 Ring telephones ring.

A related feature, Night Transfer, enables programming of up to three different CO line ringing patterns (Day, Day 2, and Night). The ringing pattern can be controlled by any station programmed with a Night Transfer button. In tenant service, there are two Night Transfer buttons on DK14 and DK40i systems and four on the DK424.

If a DK system is being used in tenant service, each tenant can separately define and control three ringing patterns using the Night Transfer1~4 buttons.

Benefits

Provides the flexibility to define CO ringing arrangements to fit the needs of the business. Calls can get to their destination quickly. CO/PBX lines can ring directly to a station or group of stations in a specific department, without going through a central Attendant. This reduces the Attendant call load and enables better service to callers. Flexible Line Ringing Assignment also enables the use of private lines in the system, and is used for tenant service.

Flexible Slot Assignment

System Availability

Unavailable for Strata DK14

Standard on DK424

Available on DK40i (expansion cabinet only)

The flexible slot architecture on DK424 systems enables almost any combination of CO line and station ports. Slots in the KSU can be assigned as station, CO line, or Option Interface slots in a variety of custom configurations. All stations, CO lines, and optional printed circuit boards are the same size and use the same connector to mount into the backplane of the base or expansion Key Service Unit cabinet.

Any printed circuit board can be installed in any slot, with the exceptions of the RCTU common control unit, which goes in designated processor slots, and the PDKU or PEKU which must be installed in slot 11 if RSIU is not used. If RSIU is used, RSIU must be installed in slot 11, in this case a PDKU or PEKU must be installed in slot 12 of the DK424 to enable system programming and system administration functions.

Benefits

Increases the variety of line/station combinations, so a customer can have a system that is sized and tailored to meet their specific needs.

Ground Start Lines

System Availability

Unavailable for Strata DK14

Optional on Strata DK40i/DK424

Requirements

Analog - one RGLU for groups of four lines

Digital - T1 Interface (RDTU)

Ground start lines provide better trunk supervision for disconnect signaling than loop start lines. This is particularly valuable in voice mail, Auto Attendant, and ACD applications. It also greatly reduces the possible collision of incoming and outgoing pooled line groups calls.

Individual circuits on the RGLU ground/loop start interface unit or RDTU T1 interface unit can be configured individually for loop start or ground start, and for DTMF or dial pulse signaling, thus maximizing performance and configuration flexibility on a line-by-line basis.

Benefits

Provides flexibility in choosing the best type of lines for the customer's application and assists in gaining the performance characteristics they require.

Hotline Service (Emergency Ringdown)

System Availability

Unavailable for Strata DK14

Standard on Strata DK40i/424 (only works with SLTs, not DKTs)

Analog single-line telephones can be programmed so that when the user goes off-hook, they automatically ring a designated extension without dialing. The receiving station or Attendant console displays the station name/number of the off-hook calling station.

This feature is very useful for hotel/motel applications, in which lobby or public area telephones either do not have dial access, or for convenience, automatically call the front desk.

This feature is also very useful for healthcare applications. If an analog single-line station is left off-hook and fails to complete the dialing of a valid number within a programmable time period, continuous ringing occurs at a designated extension.

Benefits

Provides convenience and service to hotel/motel guests calling from lobby or public area telephones. In healthcare applications, emergency ringdown operation assists callers who may not be able to complete the call by dialing.

ISDN Basic Rate Interface (BRI)

System Availability

Unavailable for Strata DK14
Optional on Strata DK40i/DK424 (Release 4.1 and higher)

BRI is the smaller capacity ISDN interface, providing two simultaneous voice or data connections. BRI uses the 2B+D transmission format which is defined as two 64 kbps bearer channels and one 16 kbps data (control) channel.

The two B-channels can also be combined for data transmission at speeds up to 128 kbps. The D-channel carries call setup control data and can also be used as a third connection for packet data transmission when using an external NT-1.

ISDN BRI services are designed mostly for end-user station interfaces. The system can connect group IV faxes, PCs, computer terminals or ports, LAN bridges and routers, video conferencing terminals, or other devices that can benefit from an all digital transmission link.

The DK40i and DK424 system also supports BRI interface from the public network as CO line service. The station-side connection supports multi-point multiple device connection to the same BRI circuit. Applications that are supported include:

- ♦ Video conferencing
- ♦ Remote access servers
- ♦ Faster Internet access
- ♦ High-speed data connections to the public ISDN network, as well as typical voice and fax connections
- ♦ Calling Number ID services
- ♦ DID

Calling Number ID services are provided through the D-channel function of ISDN's out-of-band signaling format. The ISDN link sends the Caller ID for the service originating the call. This number can be the listed DN, DID number, or a private line number used for billing, as well as identification to the called location. Caller ID blocking and screening are available options. Incoming calls are identified by Caller ID and the information is used in the DK424 like ANI. DNIS information is also provided over ISDN lines.

The Strata 40i supports the BRI interface by installing the Basic Rate Interface Unit S/T (TBSU) in the base cabinet. The TBSU provides two BRI S/T (four wire) interfaces that can be independently used for network- or station-side connections.

The following BRI S/T Interface cards are supported by DK424 Release 4.1 and higher systems. The DK40i also supports these interfaces in the expansion cabinet:

- ♦ Basic Rate S/T Interface Unit (RBSU) provides two BRI S/T (four-wire) interfaces that can be used for network- or station-side connections. It has connectors for a two-port add-on subassembly.

- ♦ Basic Rate S/T Interface Subassembly (RBSS) attaches to the RBSU to provide two additional BRI S/T interfaces that can be used for station-side connections only.

The combination of the RBSU and the RBSS subassembly can provide four BRI interfaces in one card slot.

Note Network connections using BRI S/T interface require a customer-supplied external NT-1 device.

The following BRI U Interface cards are supported by DK424 Release 4.2 and higher systems:

- ♦ Basic Rate U Interface Unit (RBUU) provides two BRI U (two-wire) interfaces that can be used for network- or station-side connections. The RBUU has connectors for a two-port add-on subassembly.
- ♦ Basic Rate U Interface Subassembly (RBUS) attaches to the RBUU to provide two additional BRI U interfaces that can be used for station-side connections only.

The combination of the RBUU and the RBUS subassembly can provide four BRI interfaces in one card slot.

ISDN Applications

ISDN features can be employed in many useful applications.

- ♦ **Calling Number Services:** The Signaling System 7 (SS7) communications network supports ISDN PRI trunks across various CO switching systems by providing end-to-end digital connectivity. In a calling number service application, for example, this extends calling number information across the entire Public Switched Telephone Network (PSTN) by passing this information across the various CO switching system nodes. Calling number information is very important in CTI applications.
- ♦ **High Speed Data:** Performance improvement (speed and accuracy) and connectivity is becoming a major factor in ISDN data-related applications. For example, a computer database interface works well on ISDN lines for large capacity file transfer, high resolution graphics transfer, online transaction processing, and information retrieval applications. ISDN provides better performance for these applications which require faster call setup and network response times than older, more restrictive analog networks can provide. ISDN also provides higher data accuracy than today's analog network.
- ♦ **Video Conferencing:** Color video transmission requires greater bandwidth and flexibility for video conferencing and related applications. Video conferencing systems integrate cameras, displays, CODECs, and control units. The CODEC can set up various transmission rates between 64 kbps and 1.5 Mbps, as required.
- ♦ **Video Telephones:** Video phones can transmit voice and image simultaneously with ISDN. Transmission of still images at high speeds is easy, as well as color moving picture communication among several parties. This integrates a telephone, a video camera with an image sensor, and a small color LCD display.
- ♦ **Multi-device Connection:** Up to eight devices can share one ISDN BRI line using station-side connections. For example, one line can accommodate two phones and multiple PCs or fax machines. The station interface is limited to two DNs. With conventional analog service, two lines are required to transmit data and talk on the phone at the same time, unless a Data Interface Unit (DIU) is used. The customer saves money by sharing CO line resources and is provided the benefits of higher speed.

- ♦ **Multiple LAN Link:** Linking multiple LANs together, using ISDN, is very efficient at the 64 kbps high-speed rates, and data transmission over the digital network provides extremely high-data accuracy. This would replace the typical LAN bridge and modems in use today, which are much slower and provide less data accuracy via the analog network. The DK40i and DK424 support BR1 station-side connection of access router devices used in these applications.
- ♦ **High Speed Fax:** G4 Facsimile offers high-speed and high-image quality. G4 Fax machines do not have to be isolated within a stand-alone system. Many G4 Fax machines can also communicate with G3 Fax machines, because the connection with existing networks is handled by the ISDN side.
- ♦ **Telecommuting:** The idea of employees working at home is a much more effective and practical option with ISDN services. The employees have access to office technology necessary to make them work almost as effectively at home as in the office.
- ♦ **Resource Sharing:** Local network functions, such as printer sharing and modem sharing, are supported by connecting these devices through terminal adapters. Users can share equipment regardless of location. It also eliminates the need for dedicated connections, since all network resources are available on a dial-up basis.
- ♦ **ISDN BRI through Centrex:** This is offered by many local exchange carriers, who offer both Centrex and ISDN lines. Blending the calling features of Centrex with BRI provides many customized capabilities. Examples are Caller ID, and the ability to set up data calls between parties using the 64 kbps B-channel without the need for lower speed modems.
- ♦ **Carrier Gateway:** This is the general “catch all” category that connects anything to anything over the PSTN. Using ISDN for this purpose provides speed, accuracy, and connectivity advantages for applications like Internet connection, e-mail, Telex, Voice Mail, and Fax forwarding.

Benefits

Faster call setup times make ISDN call connections faster, because a separate modem-type of communication with the public network is used. Calls using analog connections or T1 digital connections can take several seconds longer before the call connection is made, because they send DTMF tones and wait for audible tones in return.

Immediate Caller ID is provided on ISDN calls, because Caller ID is transmitted with each call setup message. This makes Caller ID information immediate rather than waiting for this information to be sent after starting the ringing process as with analog lines.

Higher speed digital data connection is possible on a BRI connection to the ISDN network.

DID-type functionality enables direct incoming calls to be routed and ring at designated telephones according to the number dialed. This provides DID functionality over ISDN lines without the additional expense of purchasing a block of numbers from the telephone company and subscribing to DID service.

ISDN Primary Rate Interface (PRI)

System Availability

Unavailable for Strata DK14/DK40i and DK424 using RCTUA processor

Optional on Strata DK424 using RCTUBA/BB, RCTUC/D or RCTUE/F processors

PRI is the larger capacity ISDN interface, providing 23 simultaneous voice or data connections. PRI uses the 23B+D transmission format which is defined as 23 64 kbps bearer channels and one 64 kbps data (control) channel, with total bandwidth of 1.536 Mbps.

ISDN PRI is designed as the bulk trunk interface to the ISDN network. PRI connects the DK424 telephone system to an intra- or inter-LATA communication provider. PRI can be used to send and receive voice and data.

PRI can save money by enabling the multiple use of the channels on the PRI link for a variety of services on demand, such as DID, Tie, FX, WATS, 800, etc. This capability to support multiple services and dynamically allocate channel use as needed is known as the call-by-call feature and is described in more detail below. PRI lines also support the Calling Number ID Services also described below.

ISDN PRI is supported in the DK424 system by using the Primary Rate Interface Unit (RPTU). The RPTU is a 24-channel PRI card providing 1 data (control) channel and 23 bearer channels. All B-channels appear and program as CO lines in the DK424 system and can be individually configured for local service, FX, WATS, DID, Tie line, etc. service operation. Network connection using PRI interface requires a customer supplied external Channel Service Unit (CSU).

The DK424 provides the following ISDN PRI features:

- ♦ Call-by-Call Service Selection permits the grouping of individual PRI B-channels to be shared among various types of services specified by the customer, instead of having to dedicate each channel to a particular type of service. For example, when using standard (POTS), DID, Tie, FX, WATS, and 800, the line circuits (individual or groups) of B-channels of a PRI circuit can be designated to these various services dynamically on a call-by-call basis.

B-channels can be dynamically allocated among services on a demand basis, depending on varying requirements for outgoing and incoming calls. This could also be used for voice or data on demand. This dynamic allocation of service can reduce the number of circuits required to access various services, especially if different services have peak busy periods at different times of the day.

Release 4.2 enables a minimum and maximum number of B-channels to be used for each service on this common set of B-channels in system programming. Each of these values can be set for three time periods during the day. With these values, calls can be rejected if they exceed the maximum number subscribed for that service or they can ensure that a minimum number of channels remain available for incoming calls. Thus, the system can be used to provide an optimum service to meet the objectives of the business.

- ♦ Non-facility Associated Signaling increases traffic handling on PRI lines. A single 64 kbps D-channel on one PRI line can be used to handle the signaling for two PRI lines on the DK424 system, instead of the usual signaling that requires one 64 kbps D-channel for each PRI line.

This is very important when using the Call-by-call feature to enable trunk groups larger than the 23 B-channels available on one PRI line. This extends the number of call-by-call B-channels to 47 (2 x 24 - 1) and extends the number of B-channels on the second (non-signaling) PRI line from 23 to 24. This provides better performance and cost savings in high volume ISDN PRI applications.

- ◆ Calling Number Services are provided through the D-channel function of ISDN's out-of-band signaling format. The ISDN link sends the Caller ID for the service originating the call. This number can be the listed directory number, DID number, or a private line number used for billing, as well as identification to the called location. Caller ID blocking and screening are available options. Incoming calls receive the Caller ID from the caller and is used in DK424 like ANI. DNIS information is also provided over ISDN lines.

Calling Number Services can be divided into four different types:

- ◆ Number Provisioning for outgoing calls is controlled by subscription parameters with your telco provider. The choice is for the number to be necessary or not. The number sent is based on the call originator and the call type. The originator can be a tandem call, a station (with or without DID), or a station with a designated number. The type of call refers to whether it is direct or redirected (call forwarded).

For a tandem call, the Calling Party Number digits received are the digits that are sent. For a direct station call, the default number assigned to the selected service and which is programmed into the Strata DK as the Listed Directory Number are the number that is sent. In this case, the system can send a fixed number (assigned in the system) or it can use the DID programming to determine the number to be sent.

- ◆ Number Screening is a feature of the public network. This is normally performed by the network to ensure the call being placed has a valid billing number for the call. In systems with a flexible Calling Number Provisioning, the network can perform the screening of the call to ensure the number provided is valid for billing or reject the call, rather than completing the call and billing it to the default Listed Directory Number.
- ◆ Number Privacy enables the caller to prevent the public network from delivering the Calling Number to the called party on a per-call basis. Service subscribers can request from the public network that the number be presented or not as a default. Subscribers can also select the ability to change or not change the default settings. If a public telco service enables changes to be made, then a user can enter change a code to the setting for that call after selecting a trunk group.
- ◆ Number Delivery sends the calling number with the call setup message to indicate who is calling, if that number is not blocked. When the Strata DK receives this number, it is handled the same way that ANI information from T1 trunks is handled. i.e., The number displays on the called telephone's LCD, or it can be used by TAPI interfaces, or recorded in SMDR data records, etc.

Note Name Delivery is not currently supported due to the lack of a common specification for the public ISDN network.

ISDN Applications

- ◆ Calling Number Services: The Signaling System 7 (SS7) communications backbone network supports ISDN PRI trunks across various COs. ISDN depends upon SS7 out-of-band D-channel signaling control to provide end-to-end digital connectivity. In a calling number service application, for example, this extends calling number information across the entire PSTN by passing this information across the various CO nodes. Calling number information is very important in Computer Telephony Integration (CTI) applications.

- ♦ High Speed Data: Performance improvement (speed and accuracy) and connectivity is becoming a major factor in ISDN data related applications. For example, computer database interface works well on ISDN lines for large capacity file transfer, high resolution graphics transfer, online transaction processing, and information retrieval applications. ISDN provides better performance for these applications which require faster call setup and network response times than older, more restrictive analog networks can provide. ISDN also provides higher data accuracy than today's analog network.
- ♦ Video Conferencing: Color video transmission requires greater bandwidth and flexibility for video conferencing and related applications. Video conferencing systems integrate cameras, displays, CODEC, and control unit. The CODEC can set up various transmission rates between 64 kbps and 1.5 Mbps, as required.
- ♦ High Speed Fax: G4 Facsimile via ISDN offers high speed and high image quality. G4 Fax machines do not have to be isolated within a stand-alone system. Many G4 Fax machines can also communicate with G3 Fax machines because the connection with existing networks is handled by the ISDN side.
- ♦ Telecommuting: The idea of employees working at home is a much more effective and practical option with ISDN services. ISDN can provide employees working at home access to office technology necessary to make them work almost as effectively at home as in the office.
- ♦ PRI Static Integrated Network Access: Designed to eliminate the cost of maintaining separate access lines for private-line services and switched services. The traffic over the two types of access lines can be combined over the same access line.
- ♦ Resource Sharing: ISDN lines can support local network functions such as printer sharing and modem sharing by connecting these devices through terminal adapters. This enables users to share equipment regardless of location. It also eliminates the need for dedicated connections, since all network resources are available on a dial-up basis.
- ♦ Carrier Gateway: This is the general "catch all" category that would be used to connect anything to anything over the public network. Using ISDN for this purpose provides speed, accuracy, and connectivity advantages for applications like Internet connection, e-mail, Telex, Voice Mail, and Fax forwarding.

Benefits

Enables faster call setup times because a separate modem-type communication with the public network is used. Calls using analog connections or T1 digital connections can take several seconds longer before the connection is made because of DTMF tones.

Provides immediate Caller ID because it is transmitted with each call setup message. This makes Caller ID information immediate rather than waiting for this information to be sent after starting the ringing process as with analog lines.

Enables shared use of lines for voice, data, fax, and video on each channel for multiple purposes based upon the setup request. Lines can be used for many services without the need for modems or other devices, saving you money in monthly service charges.

Provides higher speed digital data connections for higher data accuracy. ISDN provides better performance for applications that require faster call setup and network response times than older, more restrictive analog networks can provide.

Enables DID-type functionality for direct incoming calls to route and ring at designated telephones according to the number dialed. This provides DID functionality over ISDN lines without the additional expense of purchasing a block of numbers from the telephone company and subscribing to DID service.

Least Cost Routing (LCR)

System Availability

Standard on Strata DK14/DK40i/DK424

LCR enables automatic routing of each outgoing call over the least costly trunk, CO line, or common carrier. A station user simply dials the access code (9) and the telephone number. The system can also choose a specific route for long distance or local calls when enabled. Up to three schedules can be set up, enabling different routes selected at different times of the day. Up to five special codes (ones that should never be blocked, such as 911) can be exempt from LCR. [Table 8](#) lists the LCR capacities for each Strata system.

LCR	DK424					
	DK14	DK40i	RCTUA	RCTUBA/BB	RCTUC/D	RCTUE/F
LCR route plans	8	8	8	8	16	16
Area Code/Office Code (AC/OC) exception tables	8	8	8	8	16	16
Time schedules	3	3	3	3	3	3
Station classes	4	4	4	4	8	8
Route definition tables	4	4	4	4	6	6
Modify digit tables	6	6	6	6	12	12

An optional warning tone can be heard, if programmed, when the system has selected the most expensive route. The user can then wait until a less expensive line becomes available.

LCR is compatible with ABR and line-to-line connections. LCR and Toll Restriction features have the following additional capabilities:

- ♦ “Assume 9” – enables the input of four-digit Centrex numbers and be routed locally, even if the number conflicts with restricted long distance area codes.
- ♦ Special area codes that:
 - ♦ Enable input without the “1” prefix, so calls are unrestricted and routed the same as local seven-digit numbers.
 - ♦ Can be stored in a table (up to six special area codes) for areas not using standard North American Numbering Plan dialing.
- ♦ Special codes (begin or end with * or #) – overrides Toll Restriction so the call is routed locally in normal or Centrex environments. It can be used for Caller ID per-call blocking.
- ♦ Universal 976 number blocking. Four other office codes can be stored in a table to provide universal blocking.

Benefits

LCR reduces the costs of long distance calling by ensuring that each call is placed over the least costly route available to that user at that time. Placing a call is simpler for station users, since they do not have to decide which line to use, or remember how to access specific lines.

Line Call Pickup Groups

System Availability

Standard on Strata DK14/DK40i/DK424

With the CO Line Call Pickup Group feature, up to two CO Line Call Pickup Groups can be programmed on DK14 and DK40i systems and up to four groups on DK424. Ringing CO lines in the first CO line group can be picked up with an access code or with the Directed Pickup1 button, if it appears on the telephone. Ringing CO lines in the second CO line group can be picked up with an access code or with the Directed Pickup2 button, if it appears on the telephone.

As an option, all CO lines could be put into one group. A ringing CO line could then be picked up with an access code or with the Directed Pickup button.

On Strata DK systems with tenant service, the CO lines for tenant 1 could be put into one CO line group, and the CO lines for tenant 2 could be put into another CO line group. Then, tenant 1 station users can use the Directed Pickup1 button and tenant 2 station users can use the Directed Pickup2 button to pick up the CO lines assigned to them.

Benefits

Enables convenient and efficient call handling for CO line calls. Station users do not have to determine which CO line is ringing in order to answer it, nor does the ringing CO line have to appear on their telephone in order for them to pick it up.

Line Groups

System Availability

Standard on Strata DK14/DK40i/DK424

Also known as Trunk Groups, this feature enables the CO lines on any Strata system to be assigned to CO line groups. Station users can access the CO line groups by dialing a specific CO line group access code. This enables a customer to group various types of CO lines together for convenient access.

For example, a customer might want to put Tie lines in one CO line group and WATS lines in another. Users would then access the CO line group that was appropriate for the type of call being placed. If all lines in that CO line group were busy, the user could queue for the CO line group.

If the system is programmed for Least Cost Routing (LCR), station users do not need to select a specific CO line group. DK14 systems recognizes up to four CO line groups. DK40i and DK424 systems with RCTUA or RCTUBA/BB processor can be programmed for up to eight CO line groups. DK424 systems with an RCTUC/D or RCTUE/F processor can be programmed for up to 16 CO line groups.

CO line groups are also the pooled line groups that can be assigned to buttons on a DKT. Pooled Line Group 1 is CO Line Group 1, Pooled Line Group 2 is CO Line Group 2, and so on. Up to four Pooled Line Group buttons for the same CO line group can be assigned to a station to facilitate handling several calls on that CO line group at that station. See [“Pooled CO Lines”](#) for more information.

Benefits

Enables queuing, single-line telephone access to CO lines, Pooled lines, CO line Call Pickup Groups, and Tenant Service. They are also used to define LCR schemes.

Line Queuing

System Availability

Standard on Strata DK14/DK40i/DK424

This feature is also known as trunk queuing. When all lines are in use, this provides a means to “stack” station users in a waiting queue for an available outgoing CO line. The Automatic Callback feature notifies the station user when a line becomes available.

A DKT or a standard single-line station can queue up for a busy outgoing CO line or CO line group. When the desired line is available, the system calls the station back, and the station can proceed with the call.

Users save time since they do not have to keep checking to see if the line they want is free. Once they have queued for the line, they can return to their work, knowing that the system calls them as soon as the line is available.

Benefits

If LCR is installed, Line Queuing provides a convenience to users who are restricted to certain call routes.

Live System Programming

System Availability

Standard on Strata DK14/DK40i/DK424

Programming can be performed on a Strata DK system without taking the system out of service. The system can be put into programming mode, and data can be entered.

During the programming, the station executing commands is the only station that loses normal functioning. Service is not interrupted to any other station.

Live system programming can be done locally or remotely using a DKAdmin PC, if the system is equipped for remote administration/maintenance. When the system is programmed from a remote or local terminal, all stations remain functional.

Benefits

Eliminates any disruption to telephone service during the business day caused by programming adds, moves or changes. In addition, it helps control costs by eliminating the need to do these changes after hours at overtime rates.

Memory Protection

System Availability

Standard on Strata DK14/DK40i/DK424

The system memory has its own battery backup to protect the system's and customer's programmed data in the event of a power failure. The battery system is capable of retaining information for up to six years. In the event of a short-term or long-term power failure, data integrity is maintained. This means that the system programming (e.g., system parameters, toll restriction tables, station classes of service, LCR programming, ringing assignments, message and Speed Dial memory, etc.) is not lost.

Benefits

In the event of a power failure, the system data is completely reinstated upon restoration of power.

Message Waiting

System Availability

Standard on Strata DK14/DK40i/DK424 with DKTs

Standard on DK40i and DK424 with SLTs and RSTU2 PCB

Unavailable on DK14 with SLTs

The Message Waiting feature enables any station and most voice mail devices to set a Message Waiting LED at any digital/electronic station which has a Message Waiting (MSG) button. On Strata DK systems with digital telephones, there is a fixed MSG button.

The Message Waiting indication can be turned on by the calling station; or, if the station has been forwarded to voice mail, the message waiting indication is activated once the calling station leaves a message in voice mail. The station user can retrieve the message simply by pressing the Message button associated with the LED.

The Message Waiting feature on DK40i or DK424 systems also applies to standard telephones with a message waiting lamp. However, unlike the digital telephone station user who can retrieve messages by pressing a button, the standard telephone user is notified by an activated message waiting lamp on the telephone. The standard station user can enter an access code to retrieve the messages. A standard telephone with message waiting lamp must be connected to an RSTU2 station card in the DK40i or DK424. Message Waiting features on DK14 systems do not apply to standard telephones.

Up to four message waiting indicators can be set on any given station. However, the fourth indicator is always reserved for a message from the message center. This means that a maximum of three other stations can activate Message Waiting on a station at any one time.

The extension number of the station that sent the message is displayed on an LCD telephone. The total number of station numbers that can be displayed depends on the length of the station numbers. Up to eight LCD characters can be used for all of the station numbers. Thus, if station numbers are two digits long, up to four station numbers can be displayed. All station numbers can be displayed using the Scroll button.

Any station or voice mail system can be designated as a message center. There can be only one designated message center in the system, even if tenant service is installed.

If a voice mail system is assigned as the message center, the voice mail system can set message waiting at a station when a message arrives in that station's mailbox. It can also dial a code to cancel the Message Waiting LED on a station, once the station user has picked up the message.

When the voice mail system leaves a message waiting indication on an LCD telephone, a "V" is displayed next to the voice mail port extension number to indicate that the message is from the voice mail system.

When LCD messaging is used to send a silent message to the LCD telephones, an "M" is displayed next to the station DN.

Benefits

People sometimes forget to check for messages, or do so infrequently, especially if they are not located near the Attendant Console. They may not be aware that they have messages, and important messages or requests for timely callbacks can go unattended for several hours. The Message Waiting feature alerts the station user to waiting messages, thereby making the communication system more efficient and providing better service to customers and other callers.

Standard telephone applications are more feasible with Call Waiting lamp activation, especially in voice mail and hotel/motel applications. This can be important to a DK40i or DK424 customer who wants to reuse a substantial number of existing standard single-line telephones.

Multiple Directory Numbers (DNs)

System Availability

Standard on Strata DK14/DK40i/DK424

Multiple DN types provide the ultimate in call coverage flexibility. Station DN types can appear on multiple telephones, and individual telephones can have multiple appearances of their own station DN types (shown in Figure 4). All DN types can originate and answer calls.

A DN button can also release an existing call and originate another call with one press of the DN button. Press the DN button you are using to automatically release the existing call. This gives you a dial tone enabling you to make another call.

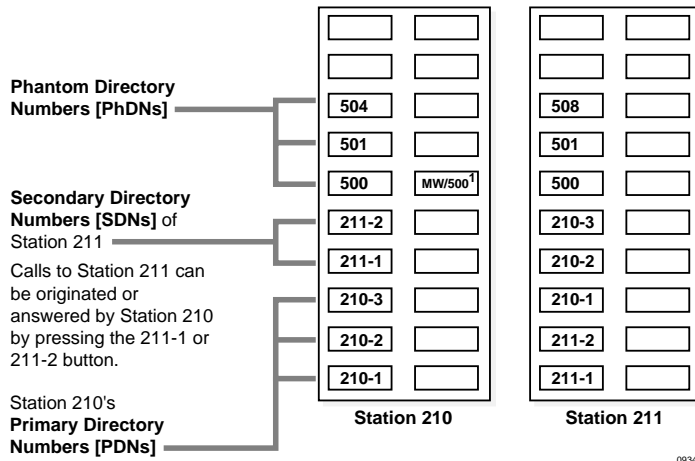

Figure 4 Multiple DNs

There are three DN types (maximums by system are given in Table 9):

- ♦ Primary Directory Number (PDN) – each telephone has a unique PDN and can have up to four button appearances of its own PDN.
- ♦ Secondary Directory Number (SDN) – when the PDN of a station appears on another station, it becomes an SDN on the other station. The PDN of one telephone can appear as a SDN on all other digital telephones and ring on all other digital telephones (except the DK424 with a maximum of 120 telephones). Incoming and outgoing calls can occur on each PDN or SDN. Each telephone can be assigned with up to four of the same SDN buttons. The maximum number PDN plus SDN buttons on each telephone is 16.
- ♦ Phantom Directory Number (PhDN) – the system also provides PhDNs that can be dedicated to a station or group of stations (usually in the same area or department). Each PhDN number can only appear once on a given telephone, but each telephone can have up to eight different PhDN buttons. A PhDN can also appear on all digital telephones on the system and can ring on all other digital telephones (except DK424 with a maximum of 120 telephones).

PhDNs are assigned to designated telephone owners in system programming with the following telephone privileges:

- ♦ Set Call Forward and Mail Box destination
- ♦ Receive Message Waiting (MW) indication for up to four PhDNs on individual PhDN/MW button LEDs
- ♦ Receive OCA when the called

Each PhDN can have a dedicated Message Waiting PhDN/MW button for message notification for the person or department associated with the PhDN. Up to four PhDN/MW buttons can be programmed into each telephone.

PhDNs (the 500-series extension numbers on the keystore in this example) are usually associated with a function such as an “800” number for a technical support group. A specific PDN is usually associated with a person.

Incoming calls come into a PDN from the top down. For example, incoming calls to Station 210 rings first at the top 210 line; the second call rings at the 210 line below it; and the third call rings at the bottom 210 line. Auto preference for DNs are from the bottom PDN up. A station PDN shows busy on Busy Lamp Field when the station is off-hook on any DN, CO line or Tie line. PhDNs do not display Busy Lamp indication.

Table 9 Maximum Multiple DNs

				DK424			
Type of Number	Digital Telephone	DK14	DK40i	RCTUA	RCTUBA/BB	RCTUC/D	RCTUE/F
PDNs	4 (same DNs)	10	28	32	80	240	336
SDNs	15 ¹	10 ²	28 ²	32 ²	80 ²	240 ²	336 ²
PhDNs	8 (different DNs)	10	28	32	80	240	336
Total DNs	20	20	56	64	160	480	672

1. Total of 16 combinations of PDN and [SDN] per telephone.
2. PDNs and SDNs are the same number.

Benefits

Multiple DNs provide the ultimate in call coverage flexibility. They are convenient and provide an easy way to answer each other’s calls or general calls to a departmental group. This is both a common requirement in most large installations and has many useful applications in smaller organizations as well.

Multiple FCC Registration

System Availability

Standard on Strata DK14/DK40i/DK424

DK14 and DK40i systems can be configured as either key or hybrid with separate FCC registration numbers for each type. DK424 systems can be configured as a key, hybrid, or PBX, with separate FCC registration numbers for each type. The appropriate configuration for an individual system depends on how it functions.

If the system is configured for only manual selection of outgoing lines, it may be registered as a key telephone system. If the system is configured for automatic selection of outgoing lines such as dial access, Least Cost Routing, and pooled line buttons, the system may have to be registered as a hybrid or PBX telephone system.

In addition, certain features (DID, Tie lines, and off-premises stations) can also require hybrid or PBX telephone system registration in some areas.

Benefits

Ensures compliance with FCC regulations regardless of how the system is configured.

Multiple Simultaneous Handsfree Intercom Paths

System Availability

Standard on Strata DK14/DK40i/DK424
with EKTs and DKTs

The intercom paths on the Strata DK systems are designed to carry handsfree conversations on all intercom calls at the same time. The digital technology of the DK systems provides completely non-blocking intercom paths and enables unlimited, simultaneous, and handsfree intercom calls.

Benefits

Non-blocking, digital technology enables any station to make a handsfree intercom call at any time.

Music-on-Hold (MOH) Interface

System Availability

Standard on Strata DK14/DK40i/DK424

A MOH/Background Music (BGM) RCA jack is built into the common control unit on DK14, DK40i, and DK424 systems. The jack connects a customer-supplied music source for MOH, BGM, or both.

The MOH interface connects the system to a customer-supplied music source. CO lines placed on hold are connected to the music source. BGM can share a music source used for MOH or have a separate source.

If a DK40i and DK424 system is configured with a tape recorder that plays a pre-recorded message to holding parties, the Option Interface Unit (PIOU, PIOUS, or PEPU) is suggested. These units have a relay that can be programmed to control a tape player every time a CO line is placed on hold. The tape recorder does not run continuously. When the relay activates, the tape plays. When the line goes off hold, the tape stops. DK14 does not support the PIOU, PIOUS, or PEPU card.

The MOH volume can be adjusted using system controls.

Benefits

Customers can realize a cost benefit with this feature, as they do not have to purchase a separate interface card for MOH (the customer provides the music source). MOH is not simply for entertaining callers while they are on hold. It also assures the caller that he or she is still connected to the system. The customer can substitute a promotional tape for a music source, enabling the customer to advertise to callers on hold.

The separate music sources available on Strata DK enables callers on hold to hear special music and/or advertising messages while station users hear and external speakers play different music.

Some firms like to select a particular type of music to reinforce an image they are trying to create.

Night Ringing Answer Code

System Availability
Standard on Strata DK14/DK40i/DK424

The Night Ringing Answer Code enables any station to answer an incoming call that rings when the system is in Night mode. The user dials a code to answer the call.

When a DK system is used in tenant service, each tenant can have a separate Call Pickup button which connects the user to the ringing call.

Benefits

Enables answering a call after hours when it rings over the external page, a night bell, or through selected telephones. Family members, other employees, and even customers can reach employees after hours. This affords peace of mind to the employees and their families.

Night Ringing Over External Page

System Availability

Standard on Strata DK14/DK40i/DK424

An option can be selected through system programming to have incoming CO line calls and door phones ring over external paging when the system is in Night mode. Night ringing over the external page can be assigned on a CO line-by-CO line basis.

Door phone ringing can also be programmed to sound over an external speaker. The call can be picked up by any telephone.

If a system is used for Tenant Service, the lines assigned to Tenant 1~4 can be programmed to ring over the external paging system. Lines for Tenants 1~4 ring according to the Night mode that is programmed for them.

Benefits

If a customer has an external paging system that gives sufficient coverage to the work area, there is no need to purchase additional equipment for night ringing. CO line calls after hours ring over the existing paging system, assuring those people working after hours that they will receive important calls.

Because ringing can be programmed on a line-by-line basis, lines which do not require attention after hours need not ring over page. This minimizes disturbance to those working after hours.

Night Ringing Over Selected Page Zone

System Availability

Optional on Strata DK40i/DK424 with PIOUS, PIOUS, or PEPU

Unavailable on DK14 (Zone Paging)

If zone paging has been installed, incoming CO line calls can be programmed to ring over selected page zones using customer-supplied paging equipment. The CO lines can be placed into two groups, and each group can be assigned to night ring over different PIOUS paging zones. Programmed lines can be divided into tenant groups which can then be assigned to night ring over the selected zones.

Programmed lines can be divided into tenant groups which can then be assigned to night ring over the selected zones:

- ◆ DK40i – two tenant groups
- ◆ DK424 – two tenant groups with RCTUA; all other processors support four tenant groups

Benefits

Enables night calls to ring over external paging and differentiate between two groups of calls. People working after hours are not bothered by calls that are not directed to their area.

Night Transfer (Day/Night Modes)

System Availability

Standard on Strata DK14/DK40i/DK424

Also known as Night Service, all Strata systems can be programmed for up to three alternate CO line ringing arrangements. They are Day, Day2, and Night.

Day mode is for normal system operation during business hours. DAY2 mode is often used for a ringing arrangement to handle calls when the Attendant is at lunch or on a break. For example, incoming calls could be sent to a secretary or Auto Attendant that has been designated as the backup Attendant. Night mode is used after hours and on weekends.

For each of the three modes, each CO line can be assigned to ring at any station in the system including off-premises stations. For example, the CO lines could be assigned to ring a voice mail port, or could ring any number of stations. For a given CO line, the ringing arrangements for each of the three modes can be entirely different. The Delayed Ringing feature can also be applied individually to all three modes.

If a CO line is programmed to ring at only one telephone in a particular ringing arrangement, a CO line call to that telephone forwards if the telephone is in the Call Forward mode. If the telephone is in a station hunt group, the call hunts.

Night Ringing can also go to external page. It can also go to a night bell and/or to an answering machine. The PIOU, PIOUS or PEPU option interface unit is required for night ringing over external page on a DK40i or DK424 system.

Benefits

Efficient handling of calls by several pre-programmed ringing arrangements. The customer can easily switch among the arrangements to handle calls at different times of day.

Non-blocking Dialing

System Availability

Standard on Strata DK14/DK40i/DK424

On Strata DK systems, Non-blocking Dialing means that all outside CO and internal DN lines can be in use simultaneously, and any station can be connected to any other station on an intercom call. Since there is no set number of intercom paths, no one would be blocked from making a call if a CO line is free.

The only potential blocking a Strata user could experience is with single-line telephones. Blocking could occur if an insufficient number of DTMF receiver circuits are installed or in an extremely high traffic situation.

Benefits

Enables buying a system that is the correct size for a business, because the system capacity is fully used at all times. The customer does not have to buy extra capacity in order to ensure that calls are never be blocked during busy hours. This non-blocking digital technology enables station users to make calls whenever they need to.

Off-premises Station (OPS)

System Availability

Optional on Strata DK14/DK40i/DK424 with standard station ports and DTMF receivers

An OPS is a standard 2500-type (DTMF/tone) or 500-type (rotary) single-line set located off-site from where the system is installed. It normally requires a special line from the CO. Secondary protectors must be installed on OPS lines. Each Strata system can support the following off-premise stations.

- ♦ DK14 – up to two OPS
- ♦ DK40i – up to a total of 20 OPS
- ♦ DK424:
 - ♦ RCTUA – up to 24 standard single-line telephones
 - ♦ RCTUBA/BB – up to 72 standard single-line telephones
 - ♦ RCTUC/D – up to 232 standard single-line telephones
 - ♦ RCTUE/F – up to 328 standard single-line telephones

Standard, single-line sets have access to many of the same features as digital stations, although the access method is different. Since the standard phone does not have feature buttons, access codes are used to activate features.

The system can be programmed to enable standard single line sets to access an outside line by dialing a CO line access code (often “9”). CO lines can be selectively included in, or excluded from, the “dial 9” group.

As a programmable option, CO line groups can be defined. The standard single line set can access a CO line group by dialing the CO line group access code. This option is useful when the set is only enabled access to a certain group of CO lines. Individual CO lines can be selected by a standard single line set by dialing “7” plus the CO line number.

A 48-volt interface is available (R48S) to extend the loop length or match the network interface.

Benefits

Enables installation of stations beyond the 1000-foot limitation of the DKT. It also enables the less expensive standard telephones to be used at satellite locations and to have access to many system features. It can eliminate the cost of installing a separate phone system.

Customers can use the less expensive standard single line telephones on-premises for employees who do not need the full complement of features afforded by the digital telephone.

Outgoing Call Restriction

System Availability
Standard on Strata DK14/DK40i/DK424

Through programming, stations can be selectively restricted from making outgoing calls on any, or all CO/PBX lines. However, a station that is restricted from making outgoing calls may still receive calls on those lines.

Because Outgoing Call Restriction is applied on a CO line-by-CO line basis, each employee's phone can be programmed so that the employee can only access those CO lines necessary to do his or her job. For example, if a set of WATS lines was installed in the system for the use of a special sales group, employees who are not in the sales group can be restricted from accessing those WATS lines.

Benefits

Provides potential cost and productivity benefits, because employees who do not need to make outgoing calls as part of their job, are restricted. In addition, if it is an employee's job to answer incoming calls, this feature ensures that the employee do not tie up those lines with outgoing calls. More efficient service can then be given to the incoming callers.

Paging - All Call Voice Page

System Availability

Standard on Strata DK14/DK40i/DK424

All Call Voice Page enables a station user to make a voice announcement through the speakers of all telephones which are not in use or otherwise blocked from receiving an all call page (maximum 120 on DK424). The user presses the All Call Page button or dials an access code and makes the announcement through the station handset. Stations that are busy on-hook or off-hook do not receive the page, even if equipped with Off-hook Call Announce.

The system can be programmed to include external paging in the All Call Voice Page. Through programming, stations can also be excluded from receiving such page announcements.

Benefits

Enables paging of all employees simultaneously without the need for an external paging system. All Call Voice Page provides this capability without the expense of an external paging system.

Even if an external paging system is installed, the All Call Voice Page feature can still be very useful. People sometimes “tune out” external paging. Paging through the phone with this feature gets attention.

Some employees may not be located within range of the external paging system. This feature can bring a paging announcement directly to their desktop.

Certain applications may not be appropriate for external paging where the paging activity might distract or disturb the clientele. In these cases, paging through the telephones provides an excellent solution.

Paging - External Page Interface

System Availability

Standard on Strata DK14/DK40i
Optional on Strata DK424 with PIOU, PIOUS, or PEPU

On DK14 and DK40i systems, there is a 600-ohm output which can be connected to a customer-provided external amplifier and compatible talk-back speaker.

On DK424 systems, an Option Interface Unit (PIOU or PEPU) can be installed to provide an internal three-watt amplifier and an external page interface. The PIOU can support zone paging with up to four zones. The PEPU can support just one zone. An optional two-way 600-ohm voice path is available on the PIOU, PEPU, or PIOUS for use with a customer-supplied talk back speaker/amplifier.

The PIOU or PEPU provides a relay contact to mute background music over external page when a voice page is in progress.

Benefits

Provides instant access to employees who do not have phones or who are away from their desks, and saves time locating them.

All Strata DK systems connect easily to an external paging system.

Paging - External Zone Paging

System Availability
Unavailable on Strata DK14
Optional on Strata D40i/DK424 with PIOU

The DK40i can support as many as four and the DK424 can support up to eight External Page Zones. Station users can access one, four, or eight zones simultaneously by dialing a brief access code.

The PIOU Option Interface Unit and customer-supplied speakers and amplifiers are required to support external zone paging. DK424 systems require two PIOU units to support eight Page Zones.

Benefits

Conveniently pages a specific area without distracting employees who do not need to hear the announcement.

Paging - Group Paging

System Availability

Standard on Strata DK14/DK40i/DK424

Any number of digital/electronic telephones can be divided into paging groups and one station can be in up to four. A unique access code is assigned to each paging group, that enables voice paging exclusively to that group. Any station user can make an announcement to just one or all of these groups (All Call Page) that is sent to the speaker of all idle telephones in the page group. The DK systems support:

- ♦ DK14 – up to five paging groups
- ♦ DK40i – up to five paging groups
- ♦ DK424 (RCTUC/D and RCTUE/F – up to nine paging groups in systems
- ♦ DK424 (RCTUA or RCTUBA/BB) – up to five paging groups

Notes

- The Cordless DKT-2004-CT or standard telephone is not compatible with paging.
- If one group is being paged, the Group Paging feature is not available to any other group until the first group page is completed.

Benefit

Enhances office efficiency by providing a quick way to contact a group of people without disrupting other workers who do not need to hear the message. When all groups are paged, everyone can hear the announcement simultaneously.

Pooled CO Lines

System Availability

Standard on Strata DK14/DK40i/DK424

A “CO line group” and a “CO line pool” are the same except a pool of CO lines can appear under one CO line button on a telephone. CO lines can be pooled in categories. For example, all WATS lines of the same type can be in one pool, all regular CO lines in another, and all Tie lines to the same destination in a third. Pooled and single-appearing line buttons are designed for use with loop- and ground-start lines, not DID, Tie, DNIS, or ANI lines.

The number of CO line groups available on Strata DK systems are as follows:

- ♦ DK14 – 4
- ♦ DK40i – 8
- ♦ DK424 with RCTUA or RCTUBA/BB – 8
- ♦ DK424 with RCTUC/D or RCTUE/F – 16

Each CO line pooled group can appear on up to four Pooled Line Grp (group) buttons on a digital telephone. This enables the user to process several calls in that CO line group at the same time. If a station user regularly processes more than one call at a time, Toshiba recommends that the station be assigned more than one Pooled Line Grp button.

It is also recommended to separate incoming and outgoing CO lines into separate groups. This prevents the accidental pickup of incoming calls when making outgoing calls.

Benefits

Provides the use of less expensive 10-button telephones instead of 20-button telephones for access to the same number of CO lines.

The Pooled Line Grp button also offers “hybrid” type system operation, even while configured for “key” operation. This also enables the Strata DK to compete more cost effectively against hybrids.

Power Failure Transfer

System Availability

Standard on Strata DK14/DK40i
Optional on DK424 with DPFT

Power Failure Transfer automatically switches CO lines directly to a standard single-line telephone and provides emergency service if commercial AC power fails. When AC power is restored, the system automatically switches back, and the standard power failure transfer telephone becomes inoperative again.

The DK14 and DK40i have one power failure transfer port as standard equipment. The DK424 required one port (DPFT) and transfers up to eight CO lines to dedicated, customer-provided single-line telephones.

The DPFT requires one port on an RSTU or RDSU, and only one DPFT can be supported per RSTU or RDSU. The DPFT 24V control connects only to an RSTU or RDSU. Multiple DPFTs can be attached depending upon the number of power failure transfer CO line circuits required.

During a power failure, the following connections are made:

- ♦ DK14 – one CO line is connected directly to the PF phone.
- ♦ DK40i – one CO line in the base KSU is connected directly to the PF phone. Up to eight more can be added in the expansion cabinet using a DPFT and RSTU.
- ♦ DK424 – multiple CO lines can be switched. If AC power is lost, the PF telephone is automatically and directly connected to the first CO line.

Benefits

Enables making and receiving calls without interruption of service.

Privacy/Non-privacy Option

System Availability

Standard on Strata DK14/DK40i/DK424

The system can be programmed as private or non-private. When the system is in the private mode, a station user who makes a call on a CO line or intercom has exclusive use of that line. Other stations cannot enter the line by pressing the Line button. When the system is in the non-private mode, other stations can enter the conversation by pressing the CO Line button.

This feature applies to CO line buttons only and does not apply to DNs. Outside CO lines can be private or non-private on a station-by-station basis. Private lines prohibit users from pressing a common CO line button and accessing a line that is already in use, whereas users can do so on non-private lines.

Private line users can change the mode by pressing the Privacy Release button enabling as many as three stations (total) on a line. Non-private users can block access to their lines by pressing the Privacy button.

Benefits

Greater flexibility because the system can be customized to meet the business' needs.

Relay Service

System Availability

Standard on Strata DK14/DK40i/DK424
(one relay)

Optional on DK424 with PIOU, PIOUS, or
PEPU (two relays)

The standard relay can be programmed for one of three options:

- ◆ External Page: A page over external speakers mutes Background Music (BGM) that is being broadcast over the same speakers.
- ◆ Night Relay: An answering machine or a night bell (or chime) are activated when a call rings in during Night mode.
- ◆ Hold Relay: A Music-on-Hold source turns on when a call is placed on hold, and goes off when the caller is taken off hold. With the relay installed, the music source does not have to play continuously.

On DK40i or DK424 systems, two relays are provided using a PIOU, PIOUS, or PEPU option card. In addition to External Page, Night Relay, or Hold Relay, these optional relays can also be programmed for Door Lock Control, which opens a customer-supplied door lock for three or six seconds when a designated button is pressed on selected telephones. See [“Door Lock Control”](#) for more information.

If a system has BGM on an external paging system, the external page relay makes it possible to suppress the BGM when a voice announcement is made over the paging system. Voice announcements can be heard clearly without interference from the BGM.

Benefits

Increases options for handling calls when the system is in night service. The customer can choose the best arrangement that meets the needs of their business.

Remote Administration/Maintenance

System Availability

Optional on Strata DK14/DK40i/DK424

Requirements

DK14 - QSMU and external modem

DK40i - PIOU or PIOUS and IMDU modem;
or RSSU and external modem

DK424 - PIOU or PIOUS and IMDU
modem; or RSSU and external modem; or
RSIU with RMDS or external modem

Remote Administration/Maintenance enables administrative and diagnostic software programs to be run “live,” without interruption of normal system operation from a remote location. The IMDU modem can operate at 300 or 1200 baud full duplex. DK424 can use the RSIU card with the RMDS modem at up to 2400 baud or an external modem at up to 9600 bps.

The Remote Administration module requires two programmable security codes for access to all programs (Level 1) or station class of service programs only (Level 2). There are six operating modes:

- ♦ Programming mode – all programs
- ♦ Data dump mode – all programs
- ♦ Test CO lines/stations
- ♦ LCD messaging – edit and set completely new messages for any DKT (system and personal messages)
- ♦ Speed dial edit/change
- ♦ DKAdmin for backup/restore and program administration (see DKAdmin description in System Overview section for details)

In order for the Remote Administration module to work, one CO/Centrex/PBX line must be connected to the system. However, this line does not have to be dedicated to the module. If the CO line is dedicated it can be programmed to ring the module directly during any ringing mode (Day, Day 2, or Night).

If automatic connection is not programmed, connection between a CO line and the module is accomplished using the Call Transfer feature. Remote administration/maintenance can also be accessed through Auto Attendant, Direct Inward System Access (DISA), and/or DID lines.

Benefits

Reduced service costs because routine service and administrative procedures can be done from the service company’s office. Service time is also reduced.

Reserve Power Battery Backup Interface

System Availability

Optional on Strata DK14/DK40i/DK424

On the DK14, an optional battery backup unit is available for the system power supply. The backup unit (HPFB-6) includes the battery pack and built-in charger and mounts externally. Either one or two HPFB-6s can be connected. If other types of batteries are used with DK14, they are not charged by the DK14 power supply.

Customer-supplied 12-volt batteries can be connected to the DK40i or DK424 systems as a power failure backup system. Batteries are connected to the system's standard power supply by an optional connector cable. The DK40i and DK424 power supplies provide a built-in battery charger. Gel-cell maintenance free batteries are recommended.

In the event of a power failure, the system automatically switches to battery power without interruption. All functions of the Strata system continue to operate for several hours after a loss of normal electrical power. The exact time period depends on the type and size of batteries used, system capacity, and traffic (see the *Strata DK General Description* for details). No calls are disconnected during the switch to battery power.

During normal power conditions, the batteries are kept fully charged by the system power supply.

Benefits

Ensures that telephone service is not interrupted by a power failure.

Speed Dial (SD)

System Availability

Standard on Strata DK14/DK40i/DK424

Also known as automatic dialing or one-button dialing, this feature enables the customer to assign dialing codes to telephone numbers that are frequently called. Each system SD number can have up to 20 digits. Two or more speed numbers can also be “chained” during one call to accommodate numbers that have more than 20 digits. Pauses and flashes can be programmed into the number. Both system and station SD numbers are available.

System Speed Dial (SSD) numbers are available to all station users. A designated station, Attendant console, or DKAdmin PC can assign the SD numbers.

The maximum number of available SD numbers is:

- ♦ DK14 – up to 40
- ♦ DK40i – up to 40
- ♦ DK424
 - ♦ RCTUA processor – up to 40
 - ♦ RCTUBA/BB processor – up to 100
 - ♦ RCTUC/D processor – up to 100
 - ♦ RCTUE/F processor – up to 800

Access to the SD numbers can be assigned on a station-by-station basis, and some stations can be restricted. If a station user is restricted from using the SD numbers, that user is automatically restricted from having station speed numbers. The SD numbers can also be programmed to override toll restriction.

If the system is installed behind a Centrex or a PBX, the SD locations can also be used for storage of Centrex/PBX feature access codes. Those codes can then be assigned to appear as automatic dialing buttons on phones that need them. In this way, Centrex or PBX feature codes can be programmed for one-button access.

SSD codes 90~99 can be pre-defined and incorporated into any other SD code to dial up to 20 digits (37 digits chained) using one code. For example, an Other Common Carrier (OCC) access number could be programmed as SD code 90. Then, SD code 90 could be used as part of the telephone number for another SD code by entering *90 as the first three digits in the telephone number for that SD code.

Station SD enables the station user to have a private automatic dialing list. Each station can have up to 40 station SD numbers. The numbers in this list can be changed by the station user at will. Station SD can be enabled or denied on a station-by-station basis.

The station user assigns a two-digit code to each of the telephone numbers, and programs a number for each code. The user can then “speed dial” the number by using the code, instead of having to dial the number manually. If the station has buttons assigned as SD buttons, one speed dial number can be programmed for each SD. Numbers not assigned to SD must be accessed with a SD code.

If SSD codes 60~90 or 600~699 have been pre-defined, they can be incorporated into a station SD code to dial up to 37 digits automatically using one code. For example, an OCC access number could be programmed as system SD code 90. Then, system SD code 90 could be used as part of the telephone number for a station SD code by entering *90 as the first three digits in the telephone number for that station SD code.

If the user has a 20-button LCD telephone with the SD memo feature, a 12-character name can be programmed for each of the 40 personal SD numbers. The LCD user can then scroll through the “memo pad” of names and numbers. When the desired name and number appears on the LCD, the user can press a CO line to automatically dial the number.

Benefits

Looking up telephone numbers can be time consuming. Errors can be made in dialing which also waste time and can be costly. By using automatic dialing for numbers that are frequently called, those time-wasters are eliminated.

Sometimes certain employees need to make business toll calls. However, it may also be desirable to toll restrict those employees, yet enable them to dial specific business toll calls using system speed dial numbers. This eliminates the possibility of telephone abuse and can reduce costs.

Station Speed Dial enables the Strata DK system to be customized. Station users can use personal Speed Dial for telephone numbers they need which are not on a System Speed Dial list.

Station Hunting

System Availability

Standard on Strata DK14/DK40i/DK424

There are three types of station hunting:

- ♦ Serial Hunting (SH) – routing of calls to the next station in a hunt group
- ♦ Distributed Hunting (DH) – routing of calls to the next hunt group

Serial Hunting

When a called station is busy, the call is routed to the next station in the hunt group. If that station is busy, the call is routed to the next station in the hunt group and so on. If a station has Call Forward set, the call that is hunting is forwarded and leaves the hunt group. Hunt group routing is assigned in the system programming database.

Assignment is flexible, so any station may hunt to any other station. Many stations may be linked together in the same chain. The hunt group may be as big as all the stations in the system, or as small as two stations.

SH can be used with PhDNs, PDNs, or a combination of these. In the case of tone ringing to multiple appearing PDNs, hunting takes place only if none of the multiple appearances of that DN are idle. If the call is Voice Announce, then hunting occurs if that PDN's station is off-hook on any DN or CO line. A ground or loop start call hunts from a PDN or PhDN *only* if it has been assigned to ring exclusively at the owner station of that DN.

Data-call serial hunting is different from voice-call serial hunting. Data-call group assignment is independent from voice-call hunt groups, but the same hunt group size characteristics as above also apply to data-call hunting.

Distributed Hunting

When a call is directed to a DH group, the systems hunts for the next available idle station in rotation order and then sends the call there. Calls are more evenly distributed than with SH. If a station has DND set, hunting skips to the next idle station.

A maximum of 16 DH groups are provided. Each group has its own unique DN which is like a pilot number. Up to 32 stations can be in any one group, and distribution can be in any rotation desired. A station can be a member of more than one group. If such is the case, the lower group number has priority. For example, a call in group seven's queue would first ring to station 201 even if another call had been in group eight's queue and had been waiting longer for station 201.

Calls can be routed to DH groups from Caller ID/DNIS/ANI lines, Tie lines, loop or ground start lines, stations transferring calls, internal direct calls, DISA calls and calls routed through built-in or external Auto Attendant. Calls forwarded from stations, or overflow calls from ACD groups can also be routed to a particular DH group (except for Call Forward Fixed).

DH group member telephones should be equipped with Pooled Line buttons if ground/loop start lines ring directly to DH groups. The routed CO line flashes only on the called members Pooled Line button.

DH member telephones should be equipped with PDNs, not CO Line or Pooled Line buttons for DID and Tie lines that directly ring to a DH Group. This is to avoid two buttons flashing on the telephone when it is called.

PhDNs cannot be assigned as members of DH groups.

ACD Overflow to DH Group (DK424 only)

ACD calls can overflow to DH groups if there is an idle agent in the DH group, but remain in the ACD queue at overflow time if all DH group members are busy.

ACD Agent Ring-No-Answer to DH Group (DK424 only)

ACD calls can route to a DH group during an agent ring-no-answer condition if there is an idle agent in the DH group. If all DH group members are busy when an agent ring-no-answer call attempts to route to the DH group, the ACD call routes to the ACD CO line normal ringing assignments.

However, once a call enters a DH group, it cannot be forwarded or serial hunted out of that group. This is to avoid falsely routing calls to personal voice mail boxes. Calls cannot be routed to DH groups by SH. Also, calls overflowing from an Attendant Console position or DID intercept calls cannot be routed to a DH group.

Calls are distributed to a station's PDN in the case of internal, DID, or Tie line calls. In the case of ground or loop start lines, Pooled Line buttons can be established on a station for separate identification of DH calls. In this case, both the Pooled Line LED and a common PhDN LED flashes. When answered, the call is resident on the Pooled Line button. Individual PhDNs cannot receive DH calls.

If no stations in a DH group are idle, new calls routed to that group are placed in a queue waiting a station to become idle. A maximum of 10 calls can be in each group's queue. Callers in queue hear ringback tone until a DH member becomes idle and the call is answered. The 11th caller trying to enter the queue receives busy tone.

Benefits

Enhances call handling by providing better service to customers and outside callers, because they usually reach someone on the first try who can help them. It can also boost productivity for internal callers, since they do not have to hang up and redial another DN if the first party does not answer.

DH is very popular in voice mail applications with all voice mail ports in a DH group. This provides very efficient use and availability of voice mail ports.

Station Message Detail Recording (SMDR)

System Availability

Optional on Strata DK14/DK40i/DK424

Requirements

DK14 - WSIU

DK40i - TSIU in base; PIOUS or PIOU in expansion

DK424 - PIOU, PIOUS, RSSU, or RSIU

SMDR prints call records of both incoming and outgoing calls or outgoing calls only. Strata DK systems can also print a call record of outgoing toll calls only. Calls of less than one or ten seconds (programmable option) are not recorded. The basic SMDR printout includes:

- ♦ Time and duration of the call
- ♦ Time to answer the call
- ♦ Stations to which the call was transferred
- ♦ Type of call – all calls, outgoing only, and toll
- ♦ Station number that made the call
- ♦ DN of the destination
- ♦ Account codes (if the system has been programmed to include)
- ♦ ANI, Caller ID, and DNIS/DID/Tie numbers/names (if the system has been programmed to include)

If present, the names take the place of the system Account Codes. A sample of the SMDR output for outgoing calls is shown in [Figure 5](#).

SMDR is supported in each system as follows:

- ♦ DK14 – requires the WSIU, equipped with an RS-232C connector for attachment to a customer-provided printer or recording device. Data output speed can be set at 300 or 1200 bps.
- ♦ DK40i – requires the TSIU, PIOU or PIOUS, equipped with an ASCII RS-232, 6-wire modular connector, compatible with most call accounting devices.
- ♦ DK424 – requires the PIOU, PIOUS, RSSU, or RSIU, equipped with an ASCII RS-232 6-wire modular connector and compatible with most call accounting devices.

The DK40i and DK424 also require a PPTC connector that converts a 6-wire, modular connection to a 25-pin connection (DB-25) and is available from Toshiba.

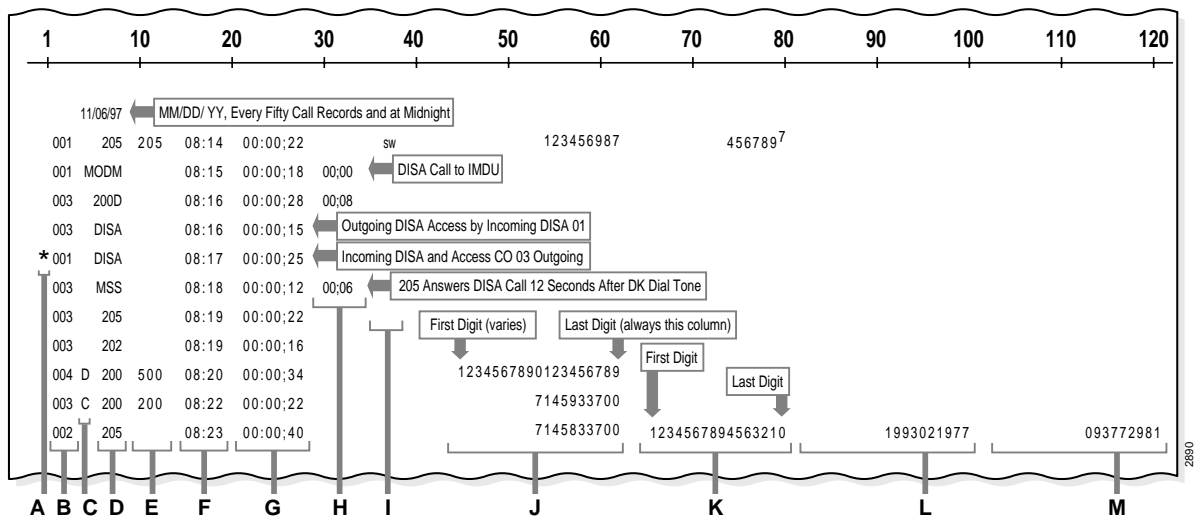

A	= Non-ISDN call established, then network disconnects. A = ISDN call established, then DK disconnects. + = ISDN call established, then network disconnects. S = Start of E911 call. E = End of E911 call. ⁴	Field Number 1
B	CO Line Number (001~144).	Field Number (2~4) ³
C	C = Caller ID Call; D = ANI or DNIS Call.	Field Number 5
D	[PDN] of the Station (1~4 digits) ² making/answering a call.	Field Number (7~10) ³
E	Primary, Secondary, or Phantom Directory Number which made/answered the call (1~4 digits). Blank if call is made from a CO line button.	Field Number (12-15) ³
F	Time of Day (HH:MM:SS). ¹	Field Number (17-21) ³
G	Call Duration (HH:MM:SS). ¹	Field Number (23-30) ³
H	CO Line Incoming Ring Duration Before Answer (MM:SS).	Field Number (32-36) ³
I	Station to which the CO line was transferred (1~4 digits).	Field Number (38-41) ³
J	Telephone Number • Incoming (1~20 digits) ⁵ • ANI (10 digits), DNIS (2~5 digits), Caller ID Number or ID Code • Outgoing Number (1~20 digits) • E911 Station ID (Prg 12)	Field Number (43-63) ³ DNIS/ANI Format: 7145833730 3846 ANI DNIS Field Number (43-52)
K	DNIS NAME ⁵ (0~16 characters); Caller ID Name ⁵ (0~16 characters), or Account Code ⁶ (4~15 digits); LCD User Name on E911 Calls	Field Number (65-80) ³
L	Outgoing Subaddress on ISDN call.	Field Number (82~101)
M	Incoming Subaddress on ISDN call.	Field Number (103~122)

1. Call Duration (incoming, outgoing, or transfer) must be 1 or 10 secs (set by Program 60-2) to generate a call record printout.
2. "MSS": designates a DISA or CF-External CO call to an unanswered station or answered after 1 or 10 secs (threshold) per Program 60-2. The call registers as a normal incoming call if answered before the threshold time. DISA calls always register 5~6 seconds ring before answer duration time.
3. Field column information is provided for SMDR output formatting purposes.
4. A "*" in the first column indicates a disconnected call by the CO Calling Party Control (CPC) or Automatic Release signal. Loop start CO lines must have Programs 15-0 and 15-3 enabled before the CPC is dropped.
5. Answered calls ANI, DNIS, and Caller ID data transmits using the SMDR port. Abandoned calls data is not transmitted, but can be stored in station memory. See Program *51 and *52.
6. See Program 60-1.
7. Strata DK sends a Carriage Return (CR) and Line Feed (LF) ASCII symbol after each line of data.

General Notes

The call record data is ASCII-formatted, 8 bits; no parity, 1-stop bit.

Special dial printout: Tone = "T", Long pause = "L", Flash = "F", Pause = "P"

"DISA": designates a DISA or CF-External call through the system via CO-to-CO connection.

"MODM": designates a call to the IMDU, Remote Maintenance Modem.

Figure 5 SMDR Output - Incoming Calls

Benefits

Save costs because telephone abuse can be pinpointed and corrected and telephone bills are properly allocated back to the departments that made the calls.

Further, since account codes are included in the SMDR printout, lawyers, accountants, and others who provide hourly professional services can accurately bill clients for telephone time.

SMDR can also help increase productivity for employees such as telemarketers who must learn to spend the optimal amount of time on each call.

Station Relocation

System Availability

Standard on Strata DK14/DK40i/DK424

There are two types of Station Relocation – moving the physical location of the telephone, or using dial codes to relocate telephone set features without physically moving its location. When Station Relocation is activated, a telephone can automatically maintain its particular characteristics (personal speed dial, flexible keys, feature set, and all DNs) when it is relocated from one modular jack to another.

A vacant jack of the same circuit type (DKT, EKT, and SLT) must be available whenever relocating a station. You can swap or remove an existing telephone to provide a vacant jack. Only one telephone can be relocated at a time. Station Relocation is available system-wide and can be turned off and on only by the System Administrator's station.

Note This feature does not work when stations are relocated from a PDKU to a KCDU in the DK40i.

Benefits

Makes moving telephones quick and easy. Just unplug the telephone from one jack and plug it into another. Saves the expense of having a third party re-program the system to reflect these changes.

System Programming Through Station

System Availability

Standard on Strata DK14/DK40i/DK424

Any Strata DK system can be programmed using a 20-button digital LCD telephone in the system. On DK424 systems, programming is done from the digital telephone connected to PDKU port 005. On DK14 and DK40i systems, programming can be done using any station port.

During programming, the station executing the commands is the only station that loses normal functioning. Service to all other stations remains normal.

Benefits

Enables simple moves and changes without purchasing additional terminal equipment. All programming can be done with a digital LCD telephone.

Tandem CO Line Connection (Trunk-to-Trunk)

System Availability

Standard on Strata DK14/DK40i/DK424

Requirements

Two CO line appearances for the DKT, or call set up on a DN

Also known as Trunk-to-Trunk Connection, this feature connects a user to two CO lines in a conference. A DKT that sets up a Tandem CO line connection must have two CO line appearances or the connection must be set up on a DN. After connection, the user can drop out of the conversation leaving the two outside parties in an unsupervised conference. The CO lines remain connected until one of the parties hangs up. Each CO line in the system can be enabled or denied the Tandem CO Line Connection feature. Each system supports:

- ♦ DK14 – two connections
- ♦ DK40i – four connections (maximum)
- ♦ DK424 – ten connections (maximum)

Amplified Conference

If the amplified conference option is installed and the amplifier is available, the Tandem CO Line Connection is automatically amplified. A trunk-to-trunk connection (up to 10 at one time) is established on each DNIS external network call.

Drop Out

On DK424 Release 3.2 and later versions, Tandem CO Line Connection – With Drop Out enables standard telephones and Voice Mail/Auto Attendant ports to set up a conference with two CO lines and then drop out of the conference leaving the two CO lines connected.

The station that sets up the two-line connection can reconnect to the tandem connection by dialing a pickup code. If more than one tandem connection is set up by a station, the pickup code reconnects that station to the tandem connection that has the lowest CO line number as a priority.

Prior to Release 3.2 software, standard telephones could set up two-line conferences, but they could not drop out of the connection. The pickup code function applies only to the station that sets up the tandem connection. A station cannot pick up a tandem connection which was set up by another station.

Automatic Release from Hold

For loop start lines, Strata systems have an Automatic Release from Hold capability that provides automatic disconnect. It recognizes the disconnect signal from the CO. If the CO does not provide the disconnect signal (most do), the trunk-to-trunk conference must be monitored and released by the station user who set it up. For ground start, DID or Tie lines handling the incoming trunk, automatic release is accomplished from disconnect supervision.

Benefits

Enables important incoming calls to be connected to employees who are out of the office, resulting in more convenient calling and efficient call handling. Internal callers who set up conference calls can drop out of the conference when they no longer need to participate. They can return to productive work and use their phone to make and receive other calls.

Tenant Service

System Availability

Standard on Strata DK14/DK40i/DK424

Businesses in the same office building can share a system. One DK14, DK40i, or DK424 (with an RCTUA processor) can be shared by two businesses. The DK424 with an RCTUBA/BB, RCTUC/D, or RCTUE/F processor can have up to four tenants.

Tenants can have separate LCR and Toll Restriction plans, Page Groups/Zones, Night Transfer ringing assignments, flexible door phone assignments, and CO line ringing assignments. CO/PBX lines for each tenant appear in the correct sequence on telephones, and each tenant can have up to two dedicated DSS consoles. Station-to-station calling can be done between the two businesses.

CO lines assigned to Tenants 1 and 2 can activate night ringing over external page. Each tenant has its own Night Transfer function and can independently control night ringing using their DSS units. Both tenants share a common night bell or a common external page zone for night ringing. With DK40i and DK424 systems, if zone paging is installed, the two CO line groups can ring over different paging zones at night.

Ringing CO lines assigned to Tenant 1 can be picked up using the Night Transfer1 button, while ringing CO lines assigned to Tenant #2 can be picked up using the Night Transfer2 button.

Benefits

Provides sharing of functions, features, and costs of a Strata DK system by two to four small companies that do not each require a separate system. They also may be able to reduce costs further by sharing a receptionist.

If the businesses are related, a common system enables them to communicate easily with each other without the expense of separate systems.

Tenant service enables the businesses to appear as two separate companies. They can have separate lines, Attendants, and ringing arrangements. Costs can be easily allocated according to use.

Tie Lines

System Availability

Unavailable on Strata DK14

Optional on Strata DK40i/DK424

Requirements

REMU (DK40i/DK424) or RDTU (T1 on DK424)

Tie lines can be installed on a DK40i or DK424 system to connect it to a PBX or another DK system in a private communications network. Tie lines can use all DNIS program assignments. Incoming Tie line calls can ring a number of destinations within the DK system.

Incoming Tie lines are enabled with Voice First Calling, and the called station can answer back handsfree. Incoming Tie lines cannot originate Off-hook Call Announce to a station at the distant end.

On the transferring station's LCD, Tie Line Transfer Recall displays the destination station number and CO line number of a CO line call transferred to a station over a Tie line to another system, when the call times out and recalls back to the transferring station. The recall timing is programmable to meet each customer's individual need. This feature enables the answering position to answer calls appropriately by knowing the difference between a new incoming call and a transferred call recalling to the Attendant.

Analog Tie lines are supported by the E&M Tie Line Unit (REMU), which provides four E&M type 1 or 2 signaling Tie lines. The Tie lines can be two-wire or four-wire transmission Tie lines and can be immediate or wink start. Digital Tie lines are supported by the T1 Interface Unit (RDTU).

A secondary protector is required for each Tie line circuit. An optional DTMF tone receiver PCB is required in Tie line operation. Tie lines can be configured as dial pulse (rotary) or DTMF (tone), and can be toll restricted.

Benefits

Helps to fix costs when the customer has heavy traffic to specific locations, because Tie lines are tariffed at a flat rate per month and are not usage dependent. If Tie lines and toll restriction are used together, there can be significant reductions in telephone expense.

Tie lines can also access features or CO lines in the distant PBX or key system providing an opportunity to further reduce costs.

Calls transferred from the answer position are often unanswered by the station to which the call is transferred. The Tie Line Transfer Recall feature works with calls transferred over Tie lines just as they would within the originating system. This feature enables the answering position to answer calls appropriately by knowing the difference between a new incoming call and a transferred call recalling to the Attendant. This provides the caller better treatment and service.

Toll Restriction

System Availability

Standard on Strata DK14/DK40i/DK424

Station users can be individually restricted from making toll calls, according to one of the three toll restriction schemes which are:

- ♦ 0/1 – system denies any CO calls with 0 or 1 as the first or second digit in the number dialed.
- ♦ Area code (three digits) – system denies any calls made by a station whose first three digits are toll restricted.
- ♦ Area code/office code (six digits) – system denies any calls made by a station whose first six digits are toll restricted.

The three- and six-digit toll restriction schemes can be further refined as follows:

- ♦ Any one of four toll restriction levels (eight with DK424 RCTUC/D or RCTUE/F) can be assigned. The levels can be defined so that each one is progressively more restrictive by enabling or denying specific area or office codes, calls to long distance information, international calls, and operator-assisted calls. The levels can be modified using up to eight exception tables that enable access to specific office codes within restricted area codes.
- ♦ A toll restricted station can still be enabled to dial 411, 911, or 800 numbers if desired.
- ♦ Traveling class of service codes can be defined, one for each level of toll restriction. When dialed at a toll restricted station, these codes change the level of toll restriction on the station to the level enabled by the code for one call. The station then reverts back to its original level of toll restriction. The codes can be changed by certain stations that are selected in programming.
- ♦ Any toll-restricted station can be assigned the credit card calling feature, which enables a user to make a “0+” telephone credit card call from that station.
- ♦ Verifiable Account Codes can have a toll restriction class of service. When such an account code is entered at a station, the station assumes the toll restriction class of service of the account code for that call.
- ♦ The Toll Restriction feature can be disabled on a given CO line. For example, toll restriction might be disabled on a Tie line, to enable the station to dial extension numbers on the distant PBX.
- ♦ Restriction levels can also be assigned to verified account codes, which require a user to enter an account code before dialing long distance. Individual lines can be defined as unrestricted.

All systems can also be programmed to recognize equal access codes (10XXX and 950-10XX), an OCC (Other Common Carrier) DN, authorization codes, and PBX access codes.

On Strata DK systems, any OPS or Tie line can be toll restricted, but it is recommended to use LCR for standard single-line telephones.

Toll Restriction Override

There are several ways to override a Toll Restriction level. They are:

- ♦ Assign three- to four-digit codes
- ♦ Use Centrex feature codes beginning with *
- ♦ Assign system Speed Dial numbers

Up to two toll restriction override codes can also be defined. When dialed at a toll restricted station, these codes enable the user of the code to override the toll restriction at that station. The codes may be changed by certain stations that are selected in programming.

See [“Toll Restriction Override Codes”](#) and [“Toll Restriction Override Using System Speed Dial”](#) for more information.

Benefits

Reduces phone bills because users can make only those toll calls that are necessary for them to carry out their job responsibilities.

Toll Restriction Override Codes

System Availability

Standard on Strata DK14/DK40i/DK424

Up to two Toll Restriction Override codes can be defined. When dialed at a toll restricted station, these codes enable the user to override the toll restriction at that station. The codes may be changed by certain stations that are selected in programming.

Up to four (eight on DK424 RCTUC/D and RCTUE/F) service code traveling classes can be defined, one for each level of toll restriction. When dialed at a toll restricted station, these codes change the level of toll restriction on the station to the level enabled by the code for one call. The station then reverts to its original level of toll restriction. The codes may be changed by certain stations that are selected in programming.

See the [“Toll Restriction”](#) for additional information.

Benefits

Enables authorized users the convenience of overriding toll restriction for more flexible outgoing calling.

Toll Restriction Override Using System Speed Dial

System Availability

Standard on Strata DK14/DK40i/DK424

System Speed Dial numbers can be programmed to override Toll Restriction. When employees need to access a toll number restricted by area/office code, an employer can assign that particular toll number as a System Speed Dial number.

After overriding Toll Restriction with system Speed Dial, the user can be enabled or blocked from dialing additional digits. Dialing long distance provider access codes (10XXX and 101XXX) is *not* allowed, except when using system Speed Dial numbers or LCR.

Benefits

Enables employees to dial specific legitimate business toll calls, without making any other calls to that particular area or office code. Preventing unnecessary toll calls can result in cost savings.

Sometimes an Attendant is asked to screen and place calls for toll-restricted users. This feature eliminates that extra work, and frees the Attendant to give more attention to incoming calls.

Transfer Privacy

System Availability

Standard on Strata DK14/DK40i/DK424

In a system programmed for Transfer Privacy, an outside call that has been transferred can only be answered at the station to which the call has been transferred or at another station using the Directed Call Pickup feature. No other station can pick up the transferred call using the CO Line button.

Privacy features only apply to CO lines and CO line button appearances. The Transfer Privacy feature does not apply to multiple DN appearances. However, if Transfer Privacy is enabled, a call that is blind-transferred to a multiple appearing DN of a CO Line, will only ring on the DN of the prime station (of a PDN) or the owner of a PhDN.

The transferred call rings on all stations having the transferred-to DN before the transferring station releases (hangs up) the call, but rings on the prime or owner station only after the call is released.

Benefits

Enables protection for the confidentiality of outside calls that have been transferred. Callers are assured that the only station that can answer the transferred call is the station to which the call has been transferred.

Traveling Class of Service

System Availability

Standard on Strata DK14/DK40i/DK424

The normal Toll Restriction class of a station can be temporarily changed to another class. Each of the four (eight in DK424 RCTUC/D or RCTUE/F) toll restriction classes of service can be assigned a four-digit code and given to users.

By entering the code at a station, a user changes the toll restriction class of service on that station to the class of service of the code, which remains in effect for the duration of the call. The station then reverts to its normal class of service. Any station can be programmed to change these codes for security purposes.

The codes do not print on the Station Message Detail Recording (SMDR) call records. However, Verified Account Codes, which can also change Toll Restriction Class of Service, print out on SMDR reports.

Benefits

Helps organizations manage telephone expenses and enables selected employees with the convenience of using any station while maintaining toll restriction control.

T1 Interface

System Availability

Unavailable on Strata DK14/DK40i/DK424 (RCTUA processor)

Optional on Strata DK424 using RCTUBA/BB, RCTUC/D, or RCTUE/F processors

The T1 Interface provides 8, 16, or 24 multiplexed, simultaneous two-way voice channels for cost-effective connection to high quality, digital CO services. This enables the system to connect to a CO, another DK424 system, or other telephone systems.

Each T1 channel can be individually configured for ANI, DNIS, loop and ground start operation, DID operation, or Tie line operation. Both Super Frame and Extended Super Frame modes are supported. T1 Interface requires the installation of a Telco or customer-provided Channel Service Unit.

T1 DID hookswitch flash capability provides hookswitch flash operation on T1 two-way DID, ground start, and Tie lines. This improves DID functionality in T1 applications. This feature requires the RDTU2 T1 card.

For E&M Tie lines, configured incoming 800, or other services, an answering position or DN must be provided to answer and transfer calls, because all calls are routed to one number. This applies for AT&T Megacom™ and like services. With multiple DNs, a Megacom call can be answered from any phone having the corresponding DN.

Ground start operation must be used with ACD or Auto Attendant. T1 loop start lines do not have any disconnect supervision.

Benefits

Provides economic advantages using the high-traffic capacity of 24 multiplexed, simultaneous two-way channels. T1 users also benefit from the increased quality of digital transmission. Access to the T1 interface is completely transparent to the station users.

Voice Mail Interface

System Availability

Optional on Strata DK14/DK40i/DK424

Requirements

Standard station ports, or RS-232 port using SMDI

Any Strata DK system can be configured with a voice mail messaging system. The system can be a Toshiba Strategy, or a customer-supplied voice mail messaging system.

When voice mail is installed with a DK system, each port on the voice mail system requires one standard single-line phone port. No external modules are required.

Depending on the voice mail product installed, some or all of the following features may be provided.

- ♦ Automated Attendant – Many voice mail systems offer Automated Attendant as part of their overall feature package.
- ♦ ANI/DNIS Routing to Voice Mailbox – Routing ANI/DNIS calls directly to a voice mailbox can be set for all calls or just calls during a particular system mode (Day, Day2, or Night). This feature is available with in-band voice mail integration only, not with SMDI.
- ♦ Call Forward to Voice Mailbox – Each user can forward calls directly to a personal mailbox. The caller bypasses the usual sequence of voice mail commands and leaves a message after hearing a greeting and/or a tone. Also, if someone calls Station A and Station A call forwards to Station B, which in turn call forwards to voice mail, the caller is connected to Station A's personal mailbox.
- ♦ Message Waiting Indication – When a message is recorded in a user's mailbox, the voice mail system automatically sets a message waiting indication at the station user's DKT, EKT, or single-line telephone with message lamp (DK40i and DK424 systems, only). The indication is turned off after the user listens to the message.
- ♦ Station Voice Mail Control – Station users can control voice mail equipment from their telephone dial pad. DK14 and DK40i stations can control voice mail equipment when not connected in a conference call. DK424 stations can control voice mail equipment on normal or conference calls with other stations and outside parties. Users with 2000-series digital telephones can also send continuous DTMF tones.
- ♦ In-band Voice Mail Integration – The integration of special voice mail features in system software enables the Strata DK and Toshiba Voice Processing systems to work together efficiently using in-band DTMF signaling tones. This is standard on the DK14, DK40i, and DK424 systems. Many other manufacturers' voice mail systems also support in-band signaling integration with DK14, DK40i, and DK424 systems.

SMDI Voice Mail Integration

SMDI voice mail integration is available for use with Strategy or non-Toshiba voice mail systems and can provide more efficient voice mail integration than in-band DTMF signaling when used in high volume applications. It requires fewer DTMF receivers and sends information quicker, because the voice mail machine processes digital RS-232 data faster than DTMF tones.

SMDI integrates Strata DK with Strategy and other voice mail systems, through a digital RS-232 connection on a WSIU, TSIU, PIOUS, PIOUS, RSSU, or RSIU using standard central office protocol, providing more universal compatibility with Strategy or non-Toshiba voice mail systems.

SMDI provides all the integration features of in-band DTMF signaling, except it does not support the equivalent of A-tone answer supervision, B-tone recall supervision, or D-tone disconnect supervision. SMDI can be important in selling Strata with non-Toshiba voice mail systems that customers may already have and want to keep to use with their new Strata DK system.

Advantages provided by the Strata DK and the Strategy SMDI integration are:

- ◆ Uses the ports faster and more efficiently. SMDI is a faster and more efficient integration compared to DTMF (in-band) integration and is recommended for high-traffic installations.
- ◆ Improves call coverage. Strategy uses the call forwarding status (all calls, no answer, busy, etc.) supplied by SMDI to provide better call coverage. Status information enables Strategy to perform custom applications using Strategy RNA and Busy Chain options.
- ◆ Streamlines messaging procedures. SMDI provides calling party extension numbers to Strategy. Users calling Strategy do not have to enter their user ID to log onto their mailboxes. When an internal party calls an extension that is forwarded to voice mail, SMDI applies the calling party identification to the message. Caller ID and ANI numbers are delivered to the voice mail machine using SMDI packets. DNIS names are not sent on SMDI packets.

Table 10 is a comparison of the feature integration provided by in-band DTMF signaling and SMDI.

Table 10 In-band and SMDI Comparison

Equipment	In-band	SMDI
A-tone (or equivalent) Answer Supervision	Yes	Yes
B-tone (or equivalent) Recall Supervision	Yes	No
D-tone (or equivalent) Disconnect Supervision	Yes	No
Option Card Required in Strata DK	No	Yes
Performance	Slower	Faster
DTMF Receivers Required	More	Fewer
Integration Software in Voice Mail System	Standard ¹	Optional ²
Available in DK14 and DK40i	Yes	Yes
Available in DK424 RCTUA	Yes	Yes
Available in DK424 RCTUBA/BB	Yes	Yes
Available in DK424 RCTUC/D	Yes	Yes
Available in DK424 RCTUE/F	Yes	Yes

1. In-band integration standard with Toshiba Strategy. It is standard with most other manufacturers, but may be optional with some.
2. SMDI integration standard with all Strategy systems. SMDI integration optional with most other manufacturers, but may be standard with some.

Benefits

The customer can gain the benefits of using a voice mail system, because it can easily be attached to a Strata system. DK systems are compatible with all Toshiba Strategy systems and many different brands of voice mail systems.

Callers can leave detailed messages for a specific employee and feel their needs are being addressed immediately, rather than neglected until the employee calls back. This uses your employees' time more efficiently and enables them to provide your customers better service.

Voice or Tone Signaling

System Availability

Standard on Strata DK14/DK40i/DK424

Any Strata DK system can be programmed for tone ringing or voice announce as the standard method of internal call signaling. With tone ring signaling selected, a station rings when called by another internal station. The called telephone receives a one-second ring tone every three seconds.

With voice announce signaling selected, a station does not ring when called on its DN/PDN by another internal station. Instead, a tone burst is heard, followed by the caller's voice over the called telephone's speaker. Voice announce signaling enables handsfree talkback from the called telephone on internal and private network Tie line calls.

Regardless of whether tone ringing or voice announce has been programmed for the system, a caller can always select the alternate method by dialing "1" after the station number.

When PhDNs are called, they always ring with tone ring signaling. Callers can select voice announce signaling by dialing "1" after the PhDn.

If there is a DSS console in the system, it can be programmed for voice or tone signaling independent of the choice for the system (DSS console is not used with DK14).

Benefits

Provides privacy and protects confidential communications. Voice signaling enables quick communication with handsfree talkback.

Wall or Table Mounting

System Availability
Optional on Strata DK424 DK14 and DK40i designed for wall mount only

The DK424 base Key Service Unit (KSU) and expansion cabinets can be wall or floor mounted even with a fully configured, seven-cabinet system. The modular DK424 cabinet configuration can be built from the bottom (base cabinet) up or from the top down.

Benefits

Enables installation almost anywhere the customer has space available.

Station Features

This section describes the features that are available to Strata DK station users. Not all of the features for digital phones are available on the digital cordless phones.

Alert Signal Button

System Availability

Standard on Strata DK14/DK40i/DK424

The Alert Signal button enables a digital or electronic telephone user to signal a designated station. Whenever the user presses the Alert Signal button, they automatically ring the designated station with a distinctive alert-ring signal. This signal alerts a person about some pre-arranged event or action. No talk path exists between the called and calling telephones.

The alerting signal is sent to phones that are idle, busy (on or off-hook), in speakerphone mode, call forwarded, or in a Do Not Disturb mode.

Each station that has this feature can send or receive the alert signal to and from another station. A station can have up to four unique Alert Signal buttons to signal to and from four different stations.

Benefits

Useful in interoffice applications to alert everyone about pre-arranged events or actions. This option is engaged with the press of a button without the need for conversation.

Automatic Busy Redial (ABR)

System Availability

Standard on Strata DK14/DK40i/DK424

Requirements

Strata DK14/40i - DKT or EKT with busy tone detectors

ABR enables a station user to automatically redial a busy outside number up to 15 times at pre-programmed intervals. Call attempts can be programmed for 30- or 60-second intervals. ABR is not attempted if the calling station is busy with another call, but the pre-programmed timer continues to run.

When the redial is successful, the calling station receives ABR ringback tone for 40 seconds or until the call is answered.

This feature can be enabled or denied on a station-by-station basis. It can be accessed by using a feature code, or it can be programmed as a feature button.

Important! *This feature is not available on outgoing Tie or DID lines.*

Automatic Busy Redial is completely compatible with Least Cost Routing functions.

Benefits

Saves time and money because the station user does not waste time looking up numbers. The system redials the number accurately, eliminating costly dialing errors, especially on long telephone numbers. Business can be completed efficiently, because the system automatically tries the number again, while the user continues to work.

Since the feature can be assigned on a station-by-station basis, a company can assign it only to those who require it. This way, CO lines are not be tied up with an excessive amount of redials.

Automatic Busy Redial can cut costs because it only redials a call on the CO line originally selected by the Least Cost Routing feature.

Automatic Callback (Internal Calls)

System Availability

Standard on Strata DK14/DK40i/DK424

A station user makes an internal call and finds the called station busy or in Do Not Disturb mode. By using a flexible button or by dialing a special code, the caller can activate Automatic Callback. When the called station is free, the system rings the caller with a special tone. When the caller answers, the system automatically rings the called party.

If the caller hears a busy tone after answering the Automatic Callback, it means that the called party has made or received another call. The callback request is not canceled, and the system rings the caller as soon as the called station is free again.

When calling a station with multiple PDNs in the ring first mode, ACB is available to the calling station only if all the PDNs of the called station are busy.

The caller can cancel the callback request at any time with a cancellation feature code.

Benefits

Minimizes user's time redialing a busy number. The caller can use that time more productively. Automatic Callback also minimizes the frustration of continuous busy signals.

Sometimes people "hang around" outside an office, waiting for someone to complete a phone call. Automatic Callback could be used to give an indication that the person is off the phone instead of wasting time "pacing the hall."

Automatic Hold

System Availability

Standard on Strata DK14/DK40i/DK424

Each station can be individually set in programming for Auto Hold or Auto Release of an existing call when another incoming call is answered. Auto Hold automatically places an existing CO line or internal call on hold when another incoming call is answered. Auto Release automatically releases an existing CO line or internal call when another incoming call is answered.

Both Auto Hold and Auto Release can be overridden by pressing the Release or Hold button, respectively, before answering another incoming call.

Benefits

Saves time in call splitting applications in which users want to switch back and forth between two calls, particularly the busy DSS operator. Auto Release saves time in heavy-call answering applications when users want to disconnect from a finished call and answer the next call simultaneously.

Automatic Off-hook Line Selection

System Availability

Standard on Strata DK14/DK40i/DK424

Requirements

DKTs or EKTs

Automatic Off-hook Line Selection enables a station to automatically access a specific line or line group and an internal PDN when the station user lifts the handset to place a call. The station user does not have to press the line button or DN button for the preferred line. The Spkr button also auto-selects the programmed line or line group and DN.

A station can be programmed to require manual selection of a line or to automatically access one of the following when the user picks up the handset to place a call:

- ♦ A specific CO/PBX line group
- ♦ An intercom or DN
- ♦ The lowest numbered CO/PBX line that appears on the DKT

If Automatic Off-hook Line Selection is not assigned, the user gets no dial tone and must manually access the line or feature.

If Automatic Off-hook Line Selection for a particular station is assigned to a CO/PBX line group, the station user gets dial tone from the last free line in that line group when the handset is lifted. The station user can dial the telephone number without pressing a CO/PBX line button. If all lines in the assigned group are busy, the user hears busy tone and can use the trunk queuing feature.

Assigning Automatic Off-hook Line Selection to a trunk group is a convenience to the user who almost always makes outside calls. If Automatic Off-hook Line Selection is assigned to an intercom or DN, the user gets internal call dial tone when the handset is lifted. The user can dial another station without using the intercom or DN button. This is a convenience to the user who almost always makes internal calls.

If Automatic Off-hook Line Selection is assigned to the lowest numbered CO/PBX line on the telephone, the user gets dial tone from that specific CO line, and can dial a telephone number without pressing the button for that line. This could be a convenience to an executive whose private line appears on that DKT.

Note Unavailable for Off-premises Station or on a standard single-line station.

Benefits

Provides the convenience of not having to look for a free line or press a line button to place the most frequently made calls.

Background Music (BGM) with Station Control

System Availability

Standard on Strata DK14/DK40i/DK424

A BGM/Music-on-Hold (MOH) RCA jack is built into the common control unit on DK14, DK40i, and DK424 systems. This jack connects a customer-supplied music source to be used for BGM, MOH, or both.

BGM can be sent to a digital or electronic telephone and external speakers. The customer-supplied background music can be applied to the telephone and external speakers, or each can have a separate music source.

If a system is connected to a music source and this feature is activated, a station user can access background music through the speaker of a digital or electronic telephone. The music can be turned on and off at the user's option using the Tel Set Music button or dialing an access code. The user can also control the volume.

If an external paging system is installed, music can also be broadcast through the external paging speakers providing background music throughout the facility. The background music over external page can be turned on and off from a telephone or Attendant Console.

No optional hardware is required when background music is broadcast over digital or electronic telephone speakers. The customer-supplied music source for both background music on telephone speakers and MOH connects directly to the common control unit.

If a separate music source for background music over telephone speakers is desired, it can connect to a designated station port. This enables separate sources for MOH and telephone background music.

Music on both the external speaker and the telephones is muted when a paging announcement is made or when night ringing occurs.

Music Sources

Each system can support the following:

- ♦ DK14 – two separate music sources, one for MOH and the other shared by DKT speaker and external speaker background music. The QSTU card provides the music source connection to designated station ports.
- ♦ DK40i – up to three separate music sources, one can broadcast background music over digital or electronic telephone speakers, another can broadcast over external speakers, and the third can provide music or a recording for MOH. The KSTU, RSTU, PSTU, PEKU, or PESU cards provide the music source connection to designated station ports.
- ♦ DK424 – up to three separate music sources one can broadcast background music over digital or electronic telephone speakers, another can broadcast over external speakers, and the third can provide music or a recording for MOH. The RSTU, RDSU, PSTU, PEKU, or PESU cards provide the music source connection to designated station ports.

Features

Station Features

On a DK40i or DK424 system, when the source input for background music over external speakers is unamplified, it can use the built-in three-watt amplifier of an Option Interface Unit (PIOU or PEPU). Amplified music output requires either the PIOU or PEPU, or the music input source can be connected through an external amplifier.

Benefits

Provides relaxing music to employees while they are working, and music that is conducive to the work environment. Conflicts over type of music played are avoided and employees have the option of simply turning off the music on their telephones.

Busy Override Tone

System Availability

Standard on Strata DK14/DK40i/DK424

After dialing an internal station and receiving a busy signal, a caller can press a Soft Key or dial a code which signals the called station with a tone burst indicating that a call is waiting. This enables a station user to send tone bursts to a busy station's idle DN or line button by dialing 2 or by pressing a feature button.

The tone burst can be sent either two times (four seconds apart) or repeated continuously every four seconds. If there are no idle DNs or line buttons on the busy station, the station receives two bursts of camp-on tone (see [“Call Transfer with Camp-on”](#) for more information).

A busy digital or electronic station can receive this tone. DKT2000-series telephone users can adjust their telephones to receive the tone over their handsets or headset receivers, as well as the speaker. Standard telephones receive camp-on tones twice from the handset receiver (it is not continuous on standard telephones).

Benefits

Provides user convenience and calling efficiency. Selected users can access busy extensions, either to give them a priority message or to announce a caller or guest.

Busy Station Transfer/Busy Station Ringing

System Availability

Standard on Strata DK14/DK40i/DK424

The Busy Station Transfer and Busy Station Ringing features operate together to ensure that a busy digital or electronic telephone station always receives transferred calls along with distinct LED and tone indications. A typical application is when an Auto Attendant device transfers calls frequently to a busy answering position station.

Digital and electronic telephones, programmed with this feature, ring and provide ringback even when they are busy on another call. This is important to voice mail and Auto Attendant applications, in which incoming calls are often transferred from the Auto Attendant to busy stations, especially the DSS station. It prevents outside callers from being sent back to the Auto Attendant or voice mail after already making their choice from the Auto Attendant or voice mail greeting.

When either an internal caller or Auto Attendant transfers an external call to a busy telephone assigned with this feature, the caller hears ring-back tone, not busy tone. The called, busy telephone rings with a muted tone, and the applicable LED flashes in synchronization with the ringing. Both the called and the calling party must be programmed for this feature. If one is not, normal operation occurs.

To answer the incoming call, the called party can transfer, release, or place the current call on hold before pressing the button associated with the flashing LED. If Auto Hold is programmed for that station, the user presses the button of the new call and the existing call is held automatically. Otherwise, the transferred call camps-on after ringing and not being answered.

If the called station is an LCD telephone, it shows which CO line is camped-on. Called stations can continue to operate other features in the normal way. If called while idle, these stations ring normally.

Any number of electronic and digital telephones can be individually programmed with this feature. Busy Station Transfer/Ringing does not operate on standard telephones.

Benefits

Ensures that important calls are answered more efficiently and reduces caller frustration by preventing them from looping back and forth from the Auto Attendant or voice mail without talking to anyone. This feature may also have applications for stations needing to get through to a busy answering position or message center without getting a busy signal.

Call Forward

System Availability

Standard on Strata DK14/DK40i/DK424

Using the Call Forward feature, a station user can route all calls to an alternate station or voice mail device. Except for fixed call forwarding, the station user selects the destination when setting call forward. Call forwarding can be set by a feature button or access code. Stations in call forward mode can originate calls as usual.

Internal DN and CO line calls that have been transferred to the station are forwarded. CO lines that ring only at that station also forward. CO lines that ring more than one station do not forward on DK14 and DK40i systems, but do forward on a DK424 system under certain conditions.

On DK424, a telephone can be designated in system programming as the Call Forward controlling telephone in applications that require ground and loop start CO lines to ring a group of telephones. The Call Forward control telephone must be only one designated to ring in the delay ring assignment, in which the call should forward.

The ringing assignment (Immediate, 12-second delay, 24-second delay) in which a CO line call forwards is designated independently for the Day, Day2, and Night Ring modes. Once assigned, the CO line follows the call forward setting (Busy, No Answer, etc.) of the designated control station. If the call forwards to voice mail, it is sent to the mailbox of the Call Forward controlling telephone's PDN or designated PhDN. This feature does not apply to Tie, DID, ANI, or DNIS lines which ring to a particular DN and follow the call forward setting of the DN.

Call Forward can be assigned to PhDNs—the type and destination can be different from the PDNs. Up to eight PhDNs can be call forward controlled from one station by the PhDN owner. A station can have up to four PhDN MW button/LEDs.

When Call Forward No Answer is active on a Handsfree Call, this option prevents a handsfree (internal call) from forwarding while engaged in a handsfree (internal call) with a station that has Call Forward No Answer or Busy/No Answer activated. This occurs even if the answering station does not press the Internal Call button to answer the call within the 12-second forwarding time. Call forwarding still occurs when the caller forces the call from Handsfree mode to Ring mode. Each station can be individually set in programming to enable or disable this feature.

The system can be programmed so that the Attendant station/DSS console can either override call forwarding and ring station users, or follow the call forwarding of called stations. If set for override, calls placed or transferred via buttons on the DSS console overrides call forwarding and ring the called station. In this case, calls placed via the dial pad of the associated digital or electronic telephone does not override, and forwards, thus giving the operator the ability to either override or forward a call. If override is not selected in programming, calls placed or transferred via buttons on the DSS console are forwarded.

Call Forwarding takes precedence over Station Hunting but not over Distributed Hunting (DH). If a station in a DH group activates call forward, calls to the DH-DN that ring that station do not forward. Calls to the station's DN do forward.

When a station is in any Call Forward mode, outgoing calls can still be made from that station. If system power is lost, Call Forward remains on stations when the power is restored.

Call Forward Modes

There are several available Call Forward modes. Each can be set and canceled by the station user. They are:

All Calls

When a station is idle or busy, all calls to the station forward immediately. The station does not ring.

Busy

When this mode is set, all calls to a busy DN immediately forwards. If a station has an idle PDN, but is busy on another DN or CO line call, calls to the PDN do not forward if the system has Ring First signaling, but do forward if the system has Voice First Signaling. If all the station's PDNs are in use, then calls to the PDN forward immediately. When a station is in the DND mode, all calls to the station's PDN forward immediately.

No Answer

When a station does not answer, the call forwards. No Answer time is flexible, 8 to 60 seconds. When the station is busy, incoming calls get busy tone. Call Forward No Answer is optional on Handsfree Answerback. OCA calls do not Call Forward. Handsfree internal calls can be programmed to automatically forward or not forward if there is no answer. If they are programmed to not forward, callers can force Call Forward with a one-digit entry.

Busy/No Answer

When a station is idle and in this mode, calls ring for 8 to 60 seconds and then forward. The Ring No Answer time can be set by the telephone user. When all the stations's DNs are busy or when the station is in the DND mode, the call will "Call Forward-Busy" immediately.

On ring first systems, if the station is busy on a call but has an idle DN, calls mute-ring the idle DN until the Call Forward No Answer timer expires and then the call forwards. This enables other users (such as a secretary) to answer the call if the called DN appears on their telephones. On Voice First systems, calls immediately Call Forward-Busy when the station is busy on a call, even if it has an idle PDN. A station in the DND mode call forwards immediately.

Fixed

A feature button can be programmed on a digital or electronic telephone to put that station in Call Forward mode to a fixed destination. The destination can be a PDN, PhDN, or Distributed Hunt DN. For example, the station may be programmed to forward to the Attendant station or a voice mail system. The destination is fixed in programming and cannot be changed by the station user. A station user with fixed Call Forward registration can also have standard call forwarding.

External

Call Forward External with remote change capability permits incoming CO line calls to be routed over an outgoing CO line to an outside directory number, increasing availability to receive incoming calls and making it efficient and easy to control.

Only incoming calls on DID or private lines can be forwarded to numbers outside the Strata DK system. Internal, Tie line, and transferred calls do not call forward externally, but do forward internally if another Call Forward mode is set simultaneously with Call Forward-External. The intention is that CO line calls ringing at multiple stations, or that can be answered by other stations internally, should be answered rather than be forwarded externally. Call Forwarding can be set for PDNs and PhDNs individually, with the exception of Call Forward External and fixed Call Forward which applies only to PDNs.

The station user has the ability to cancel or change the destination of forwarded CO line calls. This is done remotely via DISA. Toll restriction applied by DISA is also applied to externally forwarded calls. A DTMF receiver (RRCS) is required to change call forwarding remotely. External Call forward establishes a trunk-to-trunk connection.

Benefits

Ensures efficient call handling and better service to callers. It is more likely that calls to a station are answered promptly. By providing more efficient handling of calls, this feature helps a company to project a professional and courteous image, both internally and externally.

Station users can work in locations other than at their desks and not miss their telephone calls. They can forward their calls to a nearby phone. Used in conjunction with voice mail, Call Forward ensures that calls are not lost and callers have the opportunity to leave complete and detailed messages.

Call Forwarding can be set up by department or special mailbox or destination with the use of PhDNs. Using PhDNs, Call Forwarding can be set up by department, special mailbox or destination.

Call Park

System Availability

Standard on Strata DK14/DK40i/DK424

When a CO line does not have a button appearance on a station, that station can use the Park in Orbit button or a feature code to put the call on hold and make a second call. The second call can be an internal call, a page, or a CO line call. After completing the second call, the original call can be retrieved using the Park in Orbit button or a feature code. Internal station-to-station calls can be parked.

Any station user can page someone else to pick up a parked call at their station. The paged person can retrieve the call from the park orbit by dialing an access code plus the park orbit number. If a parked call is not retrieved within a pre-designated time, it recalls the parking telephone or Attendant Console. The park recall time can be individually set for each station (from 11 seconds to 15 minutes.).

Park Orbits

There are 20 general Park Orbits available. General Park Orbits are selected in the order they are available. They should only be used by LCD telephones or Attendant Consoles, because the selected Park Orbit number displays when a call is parked. In addition to general Park Orbits, each station user can park a call on its personal Park Orbit (one per station). All types of telephones can use the personal Park Orbit including standard telephones. Call Pickup is available from any station.

Park and Page

A station user can park a call in any of the general Park Orbits or in a personal Park Orbit, then enter a Page Zone or Group access code and announce to the paged party the orbit number of the waiting call. The user's telephone can be connected to a pre-designated external paging circuit, a telephone paging group, or both.

Auto Park

This feature is only available to LCD telephones. When a telephone user parks a call, the user can enter 999 instead of a specific Orbit Number. The system automatically selects the next available general Park Orbit and park the call. The parking telephone LCD shows the Park Orbit that has been automatically selected for the parked call.

Benefits

Enables convenient consultation calling for stations that do not have direct CO line appearances. Without Call Park, these stations cannot retrieve held calls. Call Park enables the station user to keep one call on hold, place another call, and return to the first call. Call Park Orbits make paging and call pickup much easier. Employees can easily pick up their calls from their personal park orbit. The Park and Page feature combines two functions into one quick-and-easy operation.

Call Pickup

System Availability

Standard on Strata DK14/DK40i/DK424

By pressing a button or dialing an access code, any station can pick up:

- ✦ PDN or PhDN calls that are on hold or ringing at other stations
- ✦ CO/DID/Tie line calls ringing at other stations, all lines or designated lines. See [“Tenant Service”](#) in the System Features section for more information.
- ✦ External or Station Group Page
- ✦ CO line ringing during the Night mode over External Page or night bell
- ✦ Door Phone calls
- ✦ Incoming CO line calls
- ✦ Parked calls
- ✦ Any ringing line or designated Tenant Group lines
- ✦ Tandem CO line connections by tandem origination telephone

To pick up a:

- ✦ Call enter a code and number of the ringing station or use the Directed Pickup button and the PDN (see the [“Call Pickup Groups”](#) for additional capabilities).
- ✦ CO line call when the ringing number is unknown, enter a specific code. See [“Computer Telephony Integration \(CTI\)”](#) in the System Features section for more information on call pickup by CO line group.
- ✦ Call using any DN at another station, enter a code and the DN (the code can also be programmed on a button). In a multiple DN environment, use DN Call Pickup because held or ringing calls can be picked up by specific PDNs or PhDNs.

Selective Pickup on All Call Page (DK424 only)

This feature enables All Call Page and External Page (depending on programming) pickup, exclusive of internal station-to-station ringing call pickup. It does not pick up ringing DNs.

Note On DK14 and DK40i systems, the pickup code picks up a ringing DN as a priority over All Call Page if the internal station-to-station call rings at the same time the All Call or External Page needs to be picked up.

Benefits

Call Pickup provides a convenience to station users by enabling them to answer their calls from another station in the area. Employees in the same work area can answer calls for others who are away from their desks, minimizing long ringing times and reducing disturbances in the work area.

Call Pickup Groups

System Availability

Standard on Strata DK14/DK40i/DK424

Call Pickup Groups enable you to pick up all types of calls including intercom or PDN calls ringing at other stations, or station groups. Calls can be picked up using programmable buttons (Group Pickup), or brief access codes that are easy to use and remember.

Station users can pick up incoming calls at any station in their own group, and can pick up calls to stations in other groups. Up to 20 Call Pickup Groups can be created to provide maximum call coverage. A station can be in more than one group. One group can have all stations.

Benefits

Provides a convenience to station users by enabling them to answer their intercom and CO line calls from another station in the area. Employees in the same work area can answer calls for others who are away from their desks, minimizing long ringing times and reducing disturbances in the work area.

Call Transfer with Camp-on

System Availability

Standard on Strata DK14/DK40i/DK424

Calls can be transferred to another station on either an announced or unannounced (immediate) basis. Immediate transfers initiated with a designated feature prompting soft key on LCD-equipped digital telephones transfer immediately after the final digit of the destination is dialed.

If the called station is not available or is busy, the call automatically camps onto it. This feature is important for stations that process a large number of calls with no time to wait for transferred calls to be answered. A “camp-on” tone (two tone bursts) is heard at the called station. The tone can be enabled or disabled for each station.

A station user can transfer a CO, DID, Tie line, or internal call to a station that is idle or busy. The call can be transferred even if the CO line does not appear on the station to which the call is transferred. An internal call, as well as a CO line call, can be transferred to another internal station.

If the transferred call is not answered, it recalls to the originating station within a pre-programmed time from 16 to 64 seconds. The recall time can be individually set for each transferring station.

As an option, the system can be programmed so that a CO button transferred call can only be picked up by the station to which it was transferred or by a station using Directed Call Pickup. See “[Transfer Privacy](#)” for more information.

Benefits

Provides an easy and convenient way to transfer calls to the appropriate people and to alert a busy station to a waiting call resulting in better service to callers.

Internal station-to-station transfer is useful for Attendant Console operators who get lots of internal calls asking for other station users.

Centrex/PBX Feature Buttons

System Availability

Standard on Strata DK14/DK40i/DK424

Feature access codes, including pauses and flashes, which access features in a host CO, Centrex, or PBX system can be programmed as if they were system speed dial numbers. Such codes can then be assigned to system Speed Dial (SD) buttons on all stations, and used for one-button access to the CO, Centrex, or PBX feature. A SD button that is programmed in this way is called a “locked” SD button.

Each feature access code can have up to 16 digits, including pauses and flashes. Buttons are assigned to system speed dial numbers in system programming.

Benefits

Provides users easy, one-button access to features that would otherwise require more complicated access procedures. Features that must be accessed through the CO/Centrex/PBX can be used more easily.

Since users do not have to look up feature access codes, SD buttons save time. Dialing errors can also be eliminated.

Continuous DTMF Signal Time

System Availability

Standard on Strata DK14/DK40i/DK424
with 2000-series DKTs

Dual Tone Multi-Frequency (DTMF) dial signal is transmitted to the CO line or voice mail/Auto Attendant device for as long as the telephone user presses a button on the dial pad. This feature operates on 2000-series digital telephones only.

The maximum DTMF duration is determined by the length of time the user presses a button on the dial pad. The minimum DTMF duration is determined by system programming. A minimum DTMF duration, either 80 or 160 ms, is required when using Speed Dial and when sending voice mail integration digits to a voice mail machine.

Benefits

Provides compatibility with a variety of outside services and devices, which require manually dialing DTMF tones of varying lengths. Application examples are MCI credit card calling, which requires holding down a button (to create a tone) for one second to make another call, or remotely signaling an answering machine to rewind by holding down a button for a specified amount of time.

Data Buttons

System Availability
Standard on Strata DK14/DK40i/DK424

Flexible buttons on 2000-series digital telephones can be programmed for data functions if equipped with the Integrated PC Interface Unit (RPCI-DI).

A flexible button on a digital telephone can be assigned as a Data Call button, that can be used to dial internal data calls. The telephone must be equipped with an RPCI-DI for Data Call button applications.

A modem button enables a digital telephone user to reserve a modem from a pool or to switch from a voice to a data call. Its LED indicates the availability of modems. The telephone must be equipped with an Integrated PC Interface Unit (RPCI-DI) for modem button applications.

Benefits

Provides programming with the touch of one button for speed and convenience.

Direct Station Selection (DSS) Buttons

System Availability

Standard on Strata DK14/DK40i/DK424

Any available button on a 10-button or 20-button digital or electronic telephone, add-on module, or DSS console can be programmed to provide a direct connection to any other telephone in the system. The LED associated with each button serves as a Busy Lamp Indicator that lights when the station named on the button is busy. Pressing the DSS button immediately rings the station assigned to that button.

Calls made with station DSS buttons forward if the station assigned to the DSS button is in Call Forward mode.

Benefits

Provides instant, one-button access to other stations, eliminating the need to repeatedly look up extension numbers to place internal calls, and show the status of the extension. This feature provides quick communication between two people who work cooperatively, such as an executive and the executive's secretary.

Distinctive LED Indicators

System Availability

Standard on Strata DK14/DK40i/DK424
with DKTs

Each line/feature button on a digital telephone has an associated LED. When a button is assigned to a CO/PBX line, this LED flashes at different rates to indicate the status of that line.

The in-use flash rate appears on the LED when the line is in use by that station. Other stations show a steady LED on that line. The incoming call flash rate appears when a call (internal or CO/PBX) is ringing in on that line. The on-hold flash rate appears on a station when the station puts a call on hold. Other stations show the usual system hold flash rate. The camp-on and busy station ringing flash rate appears when an incoming call is camped-on or ringing at a busy station. Other distinctive flash rates appear on LEDs associated with a CO/PBX line when that line is on exclusive hold, is being recalled from hold, or has a conference call in progress.

When a line/feature button is assigned to a feature, the LED indicates the status of the feature. For example, when the “Message Waiting/Flash” button indicates that a message is waiting for that station.

LEDs are also distinctive LED indicators with certain dedicated feature buttons, such as Spkr, Mic, and Msg. The Spkr LED indicates the on/off status of the speaker or background music. The Mic LED indicates the on/off status of the station’s microphone when the station is in Speakerphone mode. The Msg LED indicates there is a message waiting.

An LED associated with the DSS button functions as a busy lamp for the station assigned to the DSS button.

Digital telephones have dual-color LED indicators. Green indicates CO line or intercom buttons you are using. Red indicates use by someone else.

Benefits

Provides quick status of a line or feature by looking at the LED.

Distinctive Station Ringing

System Availability
Standard on Strata DK14/DK40i/DK424

Stations in close proximity to one another can be programmed to ring differently. Three different tones are available for incoming CO and DID line calls that are transferred to a station or ring directly to a station.

Benefits

Provides quick recognition of the ringing telephone when the user is away from their desks.

Do Not Disturb (DND)

System Availability

Standard on Strata DK14/DK40i/DK424

After DND is activated by a station, internal calls and transferred calls do not ring at the station, and voice announcements do not come through. Off-hook Call Announce is also blocked. The station user can still place outgoing calls, however.

Incoming internal and CO line calls to stations in DND do not ring the station but the DN flashes. Incoming CO line callers hear ringing until forwarded or answered by another station. Also, if a station is not in DND when an incoming internal and CO line call rings the station, the DND button can be pressed during ringing to turn off the ringing at the station, and the caller continues to hear ringing until forwarded or answered by another station.

If an internal call is placed to a station that is in the DND mode, and all the appearances of the station's PDN are in-use, the caller hears a fast busy tone. DND can be overridden by any station that has the DND Override feature or the Alert Signal button assigned to the DND telephone. Incoming CO line callers hears busy tone, unless forwarded or recalled to another station.

If a station is in the DND mode and if the station's PDN appears on another station as an SDN, the callers ring the secondary DNs providing the SDN appearance is idle and the telephone having the secondary DN is not in DND. The caller receives ring back tone. If all stations having a particular DN (PDN, PhDN, or SDN) are in the DND mode, internal callers receive fast busy tone when calling the DN.

DND can be assigned selectively on a station-by-station basis. DND can only be activated by electronic telephone or digital telephone stations, not by standard single-line telephones.

Benefits

Improves employees' time management and productivity by dedicating uninterrupted blocks of time to projects or meetings.

Do Not Disturb (DND) Override

System Availability
Standard on Strata DK14/DK40i/DK424

After dialing an internal station and receiving a DND signal, a caller with the DND Override feature can dial an access code. The called station is signaled with a tone burst, indicating that a call is waiting. If the called party has an LCD phone, the number of the calling station is displayed.

This feature can be assigned on a station-by-station basis.

Benefits

Provides convenience and efficient calling by enabling selected users access to stations which are in DND. A priority message or announcement is given about important callers or guests.

Dial Pulse/DTMF Mode Change

System Availability

Standard on Strata DK14/DK40i/DK424
with DKTs

If the Tone button has been assigned to a station, that station user can change the outpulsing mode on the CO/PBX line in use from dial pulse to DTMF with the touch of a feature button.

With some other electronic key systems, DTMF tones are generated only by the Key Service Unit (KSU) while an external number is being outpulsed. After that, the tone generator is no longer engaged, and the system simply “passes through” the generated electronic pulses. Since these electronic pulses are neither rotary nor DTMF, the user is unable to remotely operate any systems requiring DTMF tones.

The Tone button on Strata DK systems enables the user to tell the system to switch from rotary outpulse to DTMF tone outpulse when required. It also enables users who are in a location served by a rotary-only CO to generate DTMF tones for the remote operation of answering machines and other devices.

Benefits

Enables users to outpulse DTMF tones at any time. This is especially useful for the remote operation of equipment that requires DTMF tones for operation, such as answering machines, bank-by-telephone systems, dictation machines, and voice mail systems.

Exclusive Hold

System Availability

Standard on Strata DK14/DK40i/DK424

Exclusive Hold enables a station user to put a call on hold so that the call can be picked up at that station only or at another station using Directed Call Pickup. No other station can pick up the call by simply pressing the DN or the Line button. A distinctive LED flashes indicating that the line is on Exclusive Hold.

In order for the feature to work, there must be an appearance of the CO line or DN on the station activating Exclusive Hold. To activate, the user presses the Hold button twice. Each system uses the feature as follows:

- ♦ DK14 – if a DN receives a call while it is on hold, there is no audible or visual indication that another call is camped onto the DN. This assumes that there are no idle appearances of the DN, which would ring if called while another appearance of the DN is on hold.
- ♦ DK40i – if a DN receives a call while it is on hold, there is no audible or visual indication that another call is camped onto the DN. This assumes that there are no idle appearances of the DN, which would ring if called while another appearance of the DN is on hold.
- ♦ DK424 – if a telephone receives a call of any type and the DN that should receive the call is on hold, the camp-on tone is sent to that telephone. The camp-on tone consists of two muted ring tones three seconds apart.

Benefits

Enhances efficient call handling by providing a way for a station to secure a call on hold. It eliminates any annoyance to a caller caused by being accidentally picked up by another party.

Executive Override

System Availability

Standard on Strata DK14/DK40i/DK424

Executive Override can be selectively assigned to enable a station user to “break into” a conversation of a busy station. Stations with this feature programmed can enter any conversation in the system by dialing an access code or by pressing a feature prompting Soft Key. An optional warning tone signal is heard through the handset which indicates to the conversing parties that another station is about to enter the conversation. After the “break-in,” a three-way conference is in effect until one of the parties hangs up.

This feature can be assigned to any station in the system. The maximum number of simultaneous Executive Override calls is the same as the number of simultaneous conferences enabled.

Executive Override to any station can be blocked selectively in system programming providing security for modem (data) calls, voice mail calls, fax machine calls, etc.

Benefits

Enables selected stations to access a busy station for an emergency or a high-priority message.

Flash Button

System Availability

Standard on Strata DK14/DK40i/DK424
with DKTS

The Flash button serves one of two purposes:

- ♦ Disconnect a line and get CO dial tone again. If the Flash button is pressed when a station is connected to an outside loop start line, a “flash” signal is sent to the CO that is long enough to disconnect the line and get CO dial tone again.
- ♦ Operate features on a PBX or Centrex. If the Flash button is pressed when a station is connected to a PBX, the station can use the features on the PBX or Centrex.

Different flash times are usually required for each purpose. If the flash is programmed with one value only, it can perform only one of these two functions, but not both.

Benefits

Enables the user to disconnect the line and get CO dial tone again on the same CO line with one touch of a button. When a station user is making a series of CO calls or is redialing a busy number, it is inconvenient to have to press the hookswitch, release it, and access a CO line again.

When the system is installed behind a PBX, users can access PBX features that require a “flash” to operate, enabling stations to function more fully as a part of the PBX, and to take advantage of the PBX features.

Handsfree Answerback on Intercom

System Availability

Standard on Strata DK14/DK40i/DK424

When a voice-announced internal DN call comes into a digital or electronic telephone, users can answer without lifting the handset. All Toshiba digital key telephones (except the single-line model) are equipped with either Handsfree Answerback or a full speakerphone.

The Handsfree Answerback feature can be enabled or blocked on a station-by-station basis. If enabled, a station user can answer a voice call without lifting the handset by simply speaking in the direction of the phone. If the call is a tone call, the user must first press the Spkr button and then begin to talk.

The Microphn Cut-off button can be assigned to a digital telephone and used to disable the Handsfree Answerback feature to ensure private office conversation.

Note The Cordless DKT-2004-CT, Single-line Digital DKT2001, and standard telephones are not compatible with this feature.

Benefits

Provides convenience, efficient calling, and increased productivity. People who are engaged in “hands-on” work, such as engineers, architects, designers, and PC users, can carry on short conversations without having to pick up the handset.

Hearing-aid Compatible

System Availability
Standard on DKTs

All Toshiba digital key telephones are hearing-aid compatible and do not interfere with the operation of a hearing device.

The Federal Communications Commission (FCC) requires that telephones in certain locations are hearing-aid compatible. For example, emergency phones, hotel room phones, and phones in lobbies must be hearing-aid compatible.

Benefits

Provides use with hearing aid devices. Customers who install the Toshiba digital key telephones are in compliance with FCC regulations.

LCD - Alphanumeric Messaging

System Availability

Standard on Strata DK14/DK40i/DK424 with LCD telephones

If a station is equipped with a 20-button LCD telephone, system messages and personal messages can be displayed on the 32-character LCD. Forty system messages can be created, each of which can be up to thirty-two characters long. System messages can be used by all LCD telephones. For example, a system message might be: “Out to lunch,” or “Back at _____.”

A specific number of LCD stations can also create up to 10 personal messages. Each DK system had its own maximum number which are:

- ♦ DK14 – 8 stations
- ♦ DK40i (RCTUA) – 16 stations
- ♦ DK424:
 - ♦ RCTUA – 16 stations
 - ♦ RCTUBA/BB – 32 stations
 - ♦ RCTUC/D and RCTUE/F – 96 stations

Stations that are enabled for personal messages are also enabled for the personal speed dial memo feature.

System and personal messages are used with the following features:

- ♦ [Busy Station Messaging](#)
- ♦ [Called Station Messaging](#)
- ♦ [Calling Station Messaging](#)
- ♦ [Remote/Group Station Messaging](#)
- ♦ [Timed Reminders](#)

Note Busy Station Messaging and Called Station Messaging are not available when using feature prompting Soft Key operation.

Benefits

Enables station users to leave quick messages for people they call as well as for people who call them. It saves time by eliminating the need to walk to another office to leave a note or give a message to a secretary or Attendant.

LCD - Automatic Callback Number Display

System Availability

Standard on Strata DK14/DK40i/DK424
with LCD telephones

A station user makes an internal call and finds the called station is busy or in DND mode. By dialing a code, the caller activates the Automatic Callback feature. When the called station is free, the system rings the caller with a tone. When the caller answers, the system automatically rings the called party again, and display the station number of the called party.

This feature is not compatible with Call Forward-Busy. If Call Forward is required, use Call Forward-No Answer.

Benefits

Sometimes the called station is busy for a long time. If the calling station user forgets who they called and activated the Automatic Callback feature, the LCD displays the station directory number of whom they are calling.

LCD - Busy Lamp Field Indication

System Availability

Standard on Strata DK14/DK40i/DK424 with LCD telephones

The LCD indicates the status of all telephones in the system. Each 16-character LCD line displays the status of 10 stations. Two LCD lines can display 20 stations or port group numbers at a time (shown at right).

A rectangular box representing an LCD display with two lines. The first line shows '10' followed by ten dots. The second line shows '20' followed by ten dots.

The DK14 or DK40i has two-digit internal DNs and DK424 has three-digit internal DNs. The “10” stands for group 10, and each dot following represents a station number—10, 11, 12, 13, 14, and so on. Likewise, “20” stands for station group 20, and each dot following represents the station numbers—20, 21, 22, 23, 24, and so on.

A rectangular box representing an LCD display with two lines. The first line shows '200' followed by ten dots. The second line shows '210' followed by ten dots.

On DK424 systems, stations are usually numbered from 200-439 (shown above). The first PDN of 210 is shown as 0210, and each dot following represents a four-digit station number that starts with “2”—201, 202, 203, 204, and so on. Likewise, primary 0210 is shown as 0210, and each dot following represents the station numbers 211, 212, 213, 214, and so on.

If there are more than 20 stations in the system, other station numbers are displayed by pressing the Page button once (shown at right).

A rectangular box representing an LCD display with two lines. The first line shows '220' followed by ten dots. The second line shows '230' followed by ten dots.

When the Page button is pressed again, more stations display (shown at right).

A rectangular box representing an LCD display with two lines. The first line shows '230' followed by ten dots. The second line shows '240' followed by ten dots.

When a station is on-hook (free), a dot appears in the location of the station number. If a station becomes busy, the last number of that station replaces the dot. If stations 20, 24, and 37 are busy (DK14 or DK40i), the LCD displays this:

A rectangular box representing an LCD display with two lines. The first line shows '02 0 . . . 4 . . .'. The second line shows '03 7 .'. There are ten dots in each line.

When BLF is activated, no other LCD features display.

Benefits

The BLF feature on the LCD telephone enables the customer to have as many Busy Lamp Fields as needed in the business without the expense of additional Key Service Unit (KSU) hardware or extra station equipment.

LCD - Busy Station Messaging

System Availability

Standard on Strata DK14/DK40i/DK424
with LCD telephones

When one LCD station calls another and the called station is busy, the caller can send a pre-programmed LCD message (system or personal) to the busy station. A tone is heard at the called station and the message appears on the called station's LCD.

The busy station can respond with another pre-programmed message which appears on the caller's LCD. The two stations can exchange messages back and forth, creating an interactive silent "conversation."

See "[LCD - Alphanumeric Messaging](#)" for a general description of Alphanumeric Messaging.

Note Busy Station Messaging and Called Station Messaging are not available when using feature prompting Soft Key operation.

Benefits

Enables silent communication with an LCD station user who is engaged in another telephone conversation. The caller can send a message without creating background conversation (as would be the case with Off-hook Call Announce). Busy Station Messaging also ensures the privacy of the message since it can not be seen by the distant party.

LCD - Call Duration Display

System Availability
Standard on Strata DK14/DK40i/DK424 with LCD telephones

When an LCD station user is on an outgoing or incoming CO line call, the LCD displays the elapsed time of a call. Call duration may be toggled with time and date using the Page button when not in feature prompting Soft Key mode.

Benefits

Provides accurate call duration information. This is useful in applications where outside parties are billed for professional services which include telephone consultation. It also makes station users aware of how long they have been on long distance calls. This makes them more conscious of controlling telephone costs.

LCD - Call Forward Source/Destination Display

System Availability

Standard on Strata DK14/DK40i/DK424
with LCD telephones

When call forwarding is set at your telephone, all of your calls are forwarded to the destination you selected. The LCD displays the DN to which your calls are forwarded. It also shows the type of call forwarding set, which can be Call Forward Busy, Call Forward Busy/No Answer, etc.

When you call a DN, if that station is forwarded to another, your LCD display changes to the DN to which your call is being forwarded.

When an internal call is forwarded to your telephone from another station, both the calling DN and the number of the station called is displayed.

The LCD displays the “forwarded from” DN and the “forwarded to” DN if more than one DN is forwarded, a “+” sign displays, the user can press the Scroll button to scan all DNs that have Call Forward set on his/her telephone.

Benefits

Internal callers can see their call’s destination and the origin of calls received.

LCD - Calling/Called Number Display

System Availability

Standard on Strata DK14/DK40i/DK424 with LCD telephones

When an idle LCD station user receives an internal call, the LCD displays the PDN of the station that is calling, even if the call is made from a PhDN. When the user places an internal call, the LCD displays the number of the station that was dialed by the user. For incoming or outgoing CO line calls, the LCD displays the CO line in use. If user name is set, it displays in place of the station number.

Benefits

Called station users know which station is calling them on internal calls. When making internal calls, they can see who they are calling in case they are momentarily distracted. Knowing the CO line an incoming call is using is useful in paging applications.

LCD - Called Station Messaging

System Availability

Standard on Strata DK14/DK40i/DK424
with LCD telephones

An LCD telephone user can leave his or her station number and a message indication at another LCD telephone. When the called party accesses the message, the complete LCD message automatically appears on the LCD.

See “[LCD - Alphanumeric Messaging](#)” for a general description of Alphanumeric Messaging.

Note Called Station Messaging and Busy Station Messaging are not available when using feature prompting Soft Key operation.

Benefits

Enables users to leave private messages at another LCD telephone.

LCD - Calling Station Messaging

System Availability

Standard on Strata DK14/DK40i/DK424
with LCD telephones

An LCD telephone user can set a message on his or her telephone. Whenever another LCD user calls that station, the pre-selected message is displayed on the LCD of the calling station.

See “[LCD - Alphanumeric Messaging](#)” for a general description of Alphanumeric Messaging.

Note Calling Station Messaging can be used when using feature prompting Soft Key operation.

Benefits

Enables users to leave information for other LCD callers about where they can be reached or when they will return. It eliminates the need for callers to disturb a secretary or Attendant to find out where someone is, how to reach them, or when they will be back.

LCD - Clock/Calendar Display

System Availability

Standard on Strata DK14/DK40i/DK424
with LCD telephones

The date and time are continuously displayed when the LCD station is idle. Date and time can be adjusted on a system-wide basis from station port 00 for DK14/DK40i and station port 000 for DK424 or the Attendant Console. The clock/calendar can be alternated with call duration on the display during a CO line call by pressing the Page button when not in feature prompting Soft Key mode.

Benefits

This provides convenience to the user. They can see both the date and time at a glance.

LCD - CO Line Identification

System Availability

Standard on Strata DK14/DK40i/DK424
with LCD telephones

Each CO line can be identified by a 16-character name. When a user with an LCD telephone selects a CO line or receives a CO line call, the name of the CO line is displayed instead of the number. Names are assigned to the CO lines in system programming. DNIS and ANI displays have priority over CO line ID displays.

Benefits

Provides the convenience of being able to quickly verify that they are using the appropriate CO line for the current call.

When used in conjunction with the Least Cost Routing feature, the CO Line Identification feature lets the LCD user know what type of line is being used for the call. If the user sees that the call is being routed on an expensive route and the call is not urgent, he or she can choose to place it at another time. This can result in cost savings to the customer.

When used in conjunction with the Pooled Line button feature, CO Line Identification helps users identify the specific line they are using.

LCD - Dialed Number Display

System Availability

Standard on Strata DK14/DK40i/DK424
with LCD telephones

When an LCD station places a call on a CO line, the LCD displays the digits dialed. The display automatically changes from dialed number to elapsed time after a programmed period of time (system-wide choice: either 15 seconds or one minute).

Benefits

Provides verification of a dialed telephone number, so the user can see if they have misdialed. They can hang up and dial again before the party answers. If they are calling long distance, this can save money as well as aggravation.

LCD - Feature Prompting with Soft Key Operation

System Availability

Standard on Strata DK14/DK40i/DK424
with LCD telephones

Feature access is made easier with feature prompting instructions appearing on the LCD. Station users do not have to use or remember access codes or operational sequences to access commonly used features. While on a call or using a ringing phone, users can access these features by pressing one of the Soft Keys that correspond to labels displayed on the LCD. Some displays prompt users to dial a station or telephone number. As a call progresses, the labels change to provide the most logical options enabled by the user's class of service.

The example below shows a typical sequence of Soft Key LCD prompts while you are using the Conference feature. Gray is used to indicate which button to push in each step of the Conferencing sequence.

1. While talking on a CO line, the Soft Keys **TRNS**, **CONF**, and **PGE** display (shown at right).

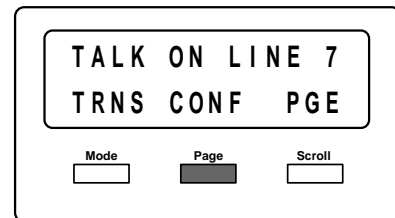

2. After pressing the button under **CONF**, the display at the right appears. In this example, you would press **STA.** to conference to another station.

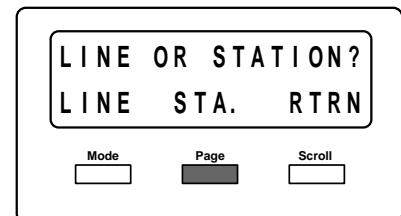

3. The LCD prompts you to dial the station number (shown at right). Press **RTRN** to cancel and the message in Step 1 displays.

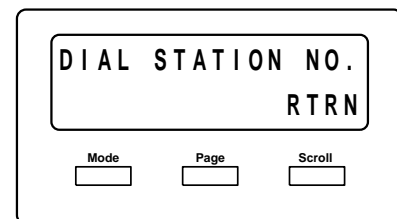

Station users can also input access codes instead of the Prompting/Soft Key mode. Turn off the Prompting/Soft Key feature using an access code and the buttons used as Soft Keys function as Mode, Page, and Scroll.

Benefits

Enables quick and more efficient call processing. Customers can use sophisticated features without being intimidated by seemingly complex procedures. Provides a user-friendly initial installation for the occasional feature user who forgets how to make a conference call or is afraid of dropping a call during one.

LCD - Message Waiting Display

System Availability

Standard on Strata DK14/DK40i/DK424 with LCD telephones

When an LCD station user activates message waiting at another LCD station, the calling LCD shows the DN of the station at which the message was left. When an LCD station user receives a message waiting signal, the display shows up to four DNs that left messages.

The messages are scrolled, right to left, by pressing the Scroll button. The fourth “message” is always reserved for a message from the message center. This means that a maximum of three stations other than the message center can leave a message on an LCD. A “V” indicates a message from voice mail. An “M” indicates a silent LCD message.

The station DNs indicating message waiting activations that can be displayed on an LCD phone depends on the length of the station DNs. Up to eight LCD characters can be used for all of the station DNs. Therefore, if station DNs are two digits long, up to four station DNs can be displayed.

Benefits

Improves interoffice communications. The station user readily sees that they have messages because the LED is lit. The LCD also displays the message information.

LCD - Recalling Station Identification

System Availability
Standard on Strata DK14/DK40i/DK424 with LCD telephones

If a transferred call goes unanswered, it recalls the station that originated the transfer, displaying both the CO line number and the station from which it is recalling.

In the DK40i and DK424 systems, if a Tie line transferred call goes unanswered, it recalls the station that originates the transfer, displaying the line number, CO line number, and the called station DN.

Benefits

Notifies the recalled station user that the call is coming back. Knowing the station and line number enables them to answer appropriately, and either transfer the call elsewhere, or provide any required special handling.

LCD - Remote/Group Station Messaging

System Availability

Standard on Strata DK14/DK40i/DK424
with LCD telephones

Remote/Group Station Messaging enables any station to set a Called Station Message for another station or group of stations. See [“LCD - Alphanumeric Messaging”](#) for a general description of Alphanumeric Messaging.

Notes

- Calling station messages can be set remotely by one station for another station, but not by one station for a group of stations.
- Remote/Group Station Messaging can be used when using feature prompting Soft Key operation.

Benefits

Saves time because the user can set the same message for an entire group at one time.

LCD - Speed Dial Memo Directory Dialing

System Availability

Standard on Strata DK14/DK40i/DK424 with LCD telephones

Station users can program a 12-character name for each of their 40 personal speed dial numbers. These are the same stations that can create personal messages. The number of stations on a Strata system that can have these features are:

- ♦ DK14 – 8 stations
- ♦ DK40i – 16 stations
- ♦ DK424 (RCTUA) – 16 stations
- ♦ DK424 (RCTUBA/BB) – 32 stations
- ♦ DK424 (RCTUC/D or RCTUE/F) – 96 stations

The station assigned to port 00 on DK14 and DK40i systems, or port 000 for DK424 systems or Attendant Consoles, can program 12-character names for the system speed dial numbers.

The LCD telephone user can scroll through the “memo pad” of names and numbers, including system speed names and numbers. When the desired name and number appears on the LCD, the user can press a CO Line button to automatically dial the number.

Benefits

Provides ease and convenience of always having a speed dial directory at their fingertips. Speed dial numbers are identified by the name of the person or company associated with the number. This ensures that the correct speed dial number is selected, and can eliminate charges for calls placed to a wrong speed dial number.

LCD - Station Identification

System Availability

Standard on Strata DK14/DK40i/DK424
with LCD telephones

When the handset is on-hook, the LCD displays the station's primary directory number as well as the time and date. If a title is programmed for the station, the station user can toggle between the title and the station number by using an access code.

Benefits

The station number is always visible. Guests or employees working in areas other than their usual workstation can conveniently reference their extension if they need to have someone call them. Station identification is also useful for technicians when troubleshooting.

LCD - Timed Reminders

System Availability

Standard on Strata DK14/DK40i/DK424 with LCD telephones

LCD telephone users can define up to five separate messages and have each message appear on their LCD at a specific time. When the message appears, the station user hears a muted ring for 30 seconds, or until the handset is lifted or the Mode button is pressed.

The user can program a message to appear just once, or to appear at the same time each day. The number of stations that can have these features are:

- ♦ DK14 – 8 stations
- ♦ DK40i – 16 stations
- ♦ DK424 (RCTUA) – 16 stations
- ♦ DK424 (RCTUBA/BB) – 32 stations
- ♦ DK424 (RCTUC/D or RCTUE/F) – 96 stations

A variation on this feature is available on all digital telephones even without an LCD. Digital telephone users can program up to five timed “alarm” reminders. At the appointed times, the user gets a 30-second muted ring.

Benefits

Provides a convenient, simple way to remind users of appointments or other responsibilities. It can help eliminate the need to “write notes to oneself,” which often get misplaced on a busy desk.

LCD - User Name/Number Display

System Availability

Standard on Strata DK14/DK40i/DK424
with LCD telephones

Station users with LCD telephones can program a title (name, location, etc.) of up to 16 characters in station memory. When the station is idle, the name displays on the top line of the station's LCD. The station user has the option of using a simple access code to "toggle" between the title display and the usual station number display.

When the station calls another LCD station, whichever display is on the calling station appears on the bottom line of the called station. When feature prompting Soft Key mode is on, the name of a called station appears on the calling station's LCD.

Non-LCD stations, including standard telephones, electronic telephones, and voice mail ports, can be programmed to send a name to LCD stations that they call.

Benefits

Called station users know at a glance who is calling, without having to recognize the station directory number.

Message Waiting

System Availability

Unavailable on DK14 with SLTs

Standard on Strata DK14/DK40i/DK424 with DKTs

Standard on DK40i/DK424 with SLTs with RSTU2

If you call a station and the user does not answer, you can leave a message waiting indication by pressing the Msg button. The Msg LED at the called station flashes for message notification. If an LCD phone is used, message information is also displayed. Voice mail devices can also leave message waiting indications. The called station user can call you back by pressing the Msg button with the flashing LED.

The Message Waiting feature on DK40i and DK424 systems also applies to standard telephones with a message waiting lamp. The standard station user enters an access code to retrieve messages or initiate a callback. A standard telephone with message waiting lamp must be connected to an RSTU2 station card in the Strata DK system. Message waiting features on DK14 systems do not apply to standard telephones.

Up to four Message Waiting indications may be left at a station at one time. One of the indications is reserved for the Message Center set in system programming.

Benefits

Improves interoffice communications because the user readily sees they have messages (LED is lit and flashing). The LCD, if used, also displays message information.

Standard telephone applications are more feasible with Call Waiting lamp activation, especially in voice mail applications. This can be important when selling a DK424 to a customer who wants to reuse a substantial number of existing standard single-line telephones.

With Multiple DN's, up to four flexible buttons function the same as, in addition to, the fixed Msg button LED. These four button LEDs can only appear on the station that owns the PhDN's.

Microphone Control Buttons

System Availability

Standard on Strata DK14/DK40i/DK424 with DKTs

Digital telephones can be programmed with a Microphn Cut-off button, which turns the microphone inside the telephone on and off while idle.

If a Microphn Cut-off button is assigned on a station, the station user can enable or disable the Handsfree Answerback microphone for that station when the station is in the idle state. This is used for station security and ensures that a private office conversation is not heard when the Handsfree Answerback is enabled. This function also blocks room monitoring.

The operation of the Microphn Cut-off button can be assigned as either auto-on or auto-off in programming. This enables each station user to use the Microphn Cut-off button whichever way is best for them.

When used during a speakerphone conversation, a fixed Mic button disables and enables the station's microphone. This enables the station user to temporarily block the other party from hearing the conversation.

Benefits

Ensures that no intercom callers can hear private office conversations (if the system is programmed for voice signaling) when the caller is using Handsfree Answerback feature. The Microphn Cut-off button disables Handsfree Answerback.

The Mic button is especially helpful when multiple people are talking through the speakerphone to the party on the other end. Using the Mic button, they can confer among themselves while preventing the other party from hearing their conversation.

Modular Handset and Line Cords

System Availability
Standard on all Toshiba DKTs

All Toshiba digital key telephones have modular handsets and can connect to the system by standard one or two-pair modular line cords. Handsets and/or cords can be interchanged by the end user as desired. Line cords come in three different lengths; handset cords are available in 6 or 13 feet lengths.

Benefits

Gives the customer the flexibility to use long coil or line cords, as required. Modular cords also simplify maintenance; reducing the time and cost of repair.

Modular Headset Interface

System Availability

Optional on all Toshiba DKTs

Every 10-button and 20-button telephone can be upgraded to provide a modular headset jack and a loud ringing bell interface. An upgrade assembly (HHEU2) is installed inside the phone.

Most standard carbon-type headsets plug into the HHEU2 jack and are compatible with the electronic telephone. Both options may be installed simultaneously. If a 2000-series digital telephone is upgraded with a data interface unit, it can also have the HHEU2 assembly.

Benefits

Simplifies the use of headsets for customers who want them for convenience or productivity.

Off-hook Call Announce (OCA)

System Availability

Standard on Strata DK14/DK40i/DK424 with DKTs (Handset OCA)

Optional on DK14/40i/424 with DKTs (Speaker OCA)

A station user can send an announcement to a busy digital/electronic telephone. The internal call must be directed to a PDN or PhDN, if it is the PhDN owner. Only the PhDN owner can receive OCA. OCA does not occur when calling SDNs.

OCA uses two different methods of operation—handset/headset or speaker mode. It can be set individually for each telephone that receives OCA.

Any telephone can originate OCA using intercom dialing, transfer/conference dialing, or DSS. There are no special requirements to enable a digital, electronic, or conventional single-line telephone to make OCA calls. The feature is activated automatically or by dialing 2, depending on how the station is programmed.

Stations receiving OCA must be assigned with OCA-receiving capability in system programming and be a proprietary digital/electronic telephone. Standard single-line telephones cannot receive OCA.

Note The digital telephone only requires standard one-pair cabling.

Handset Mode

The OCA is sent to the called telephone handset or headset receiver. The OCA called station user, while off-hook and engaged in a conversation, hears an OCA warning tone (optional) and announcement over the handset. The Cordless DKT-2004-CT also receives the warning tone and announcement. This method of OCA does not require the DVSU in the telephone.

The called station hears the original and the OCA calling party. The called station user responds to the OCA calling party by holding down the Mic button and talking into the telephone handset or headset transmitter. The original outside talking party does not hear the OCA calling party or the station user's response, so this is a more private method of OCA than the speaker OCA mode.

A HS OCA Talkback button can be programmed on a digital telephone feature button to operate with "push-on" and "push-off" mode for each individual telephone that receives OCA. When the OCA button is pressed on, the outside caller hears Music-on-Hold, and the internal parties are in a two-way, dedicated conversation.

Speaker Mode

The OCA is sent to the called telephone speaker. When the OCA announcement is heard over the speaker, user can respond to the OCA caller by talking into the telephone microphone. There exists two simultaneous two-way conversations, so the OCA call is heard by other people near by, or by the outside original talking party, depending upon the speaker volume setting.

If the called station is using the speakerphone or the Handsfree Answerback feature, the caller gets a busy signal. If the called station is in Do Not Disturb mode, OCA is blocked.

This method of operation is available on all Strata DK systems, but requires a DVSU in the digital telephone set receiving OCA.

Note The PC Data Interface (RPCI-DI) cannot be used if speaker mode OCA is installed, or vice versa. The Cordless DKT-2004-CT telephone is not compatible with Speaker OCA.

Benefits

Ensures that users get important telephone calls. A caller with an important message gets through to the called party, even if the called party is using the telephone. The caller contacts the called party directly rather than through an anonymous “camp-on” tone, which is often ignored.

On-hook Dialing

System Availability

Standard on Strata DK14/DK40i/DK424 with DKTs

A station user can dial any call without lifting the handset and hear the progress of the call (outpulsing, ringing, busy signal, and intercept announcements) through the speaker. The user must lift the handset in order to converse with the called party unless the telephone is a full speakerphone. On-hook Dialing is available on all digital telephones.

Benefits

Provides convenience and comfort to the station user. Often a station user makes a call, only to get a recording, and a request to “wait for the next available agent.” Not wanting to waste time, the user holds the phone with his/her shoulder, to free his hands to do something else. Being able to monitor the call with the handset on-hook eliminates the discomfort of “shoulder hold.”

On-hook Dialing also provides monitoring capability without the expense of a full speakerphone.

Personal Computer Interface (RPCI-DI)

System Availability

Optional on Strata DK14/DK40i/DK424 with 2000-series DKTs

Requirements

RPCI-DI

Digital telephones that are equipped with an RPCI-DI connect to a PC or ASCII terminal to make data calls to printers, PCs, and other data devices. Users also make voice calls using PC directory dialing software without the need of a modem or an extra outgoing line. The system is programmed with 1~4 security groups and restricts calls between groups. It also supports modem pooling and printer sharing.

These digital telephones are connected to a computer with application software using the Microsoft Telephony Application Programming Interface (TAPI) to provide customized functionality through Computer Telephony Integration (CTI). Any TAPI enabled PC software is compatible with Strata DK systems.

The most common example of this type of application is using the computer for database lookup and pop-up screens containing information on the calling party. Caller ID, Automatic Number Identification (ANI), Dialed Number Identification Service (DNIS), and call processing information can be passed from the digital telephone to the application computer to provide the information necessary for the application's database lookup and pop-up screens. This is especially useful with ACD applications (DK424 only).

See [“Computer Telephony Integration \(CTI\)”](#) for more information.

Benefits

CTI provides an efficient and convenient custom functionality to the user's business telephone system. By combining the two technologies, users gain functionality that is not provided by either the telephone or the computer. Users choose among many TAPI enabled PC software packages that provide custom functions for their specific needs.

Simultaneous voice and data transmission over a single-wire pair eliminates additional wiring requirements and minimizes port usage on the system.

Modem pooling and printer sharing enables multiple users to maximize efficient usage of expensive peripheral devices.

PC keyboard dialing of data or voice calls increases user efficiency. An example is auto dialing by name or initial from directories stored in PCs equipped with inexpensive desk organizer-type software (modem not required).

Security groups help control who is authorized to make outside data calls, which can get expensive if linked to databases which charge for access.

Pooled CO Line Buttons

System Availability

Standard on Strata DK14/DK40i/DK424 with DKTS

Pooled Line Group buttons enable a group of CO lines to “appear” under one button. Pooled and single appearing line buttons are designed for use with loop and ground start lines, not Tie, DID, DNIS or ANI lines.

A maximum of eight CO line groups can be defined on a system (16 CO line groups on a DK424 with RCTUC/D and RCTUE/F processor). A CO line group can be assigned to up to four Pooled Line Grp buttons on a digital telephone. Multiple appearances of the CO line group can facilitate handling several calls on lines in the same group.

If a station user regularly processes more than one call at a time, it is recommended that the station be assigned more than one Pooled Line Grp button. It is also recommended to separate incoming and outgoing CO lines into separate groups. This prevents the accidental pickup of incoming calls when making outgoing calls.

A CO line group is accessed for an outgoing call by pressing the Pooled Line Grp button, or by using an assigned access code.

Benefits

Saves money for the customer, since the less expensive 10-button telephones can be used instead of 20-button telephones to provide access to the same number of lines. They also offer a “hybrid” type operation enabling the Strata DK to compete more effectively against other hybrids.

Privacy Button

System Availability

Standard on Strata DK14/DK40i/DK424
with DKTs and EKTs

If a Strata DK system has been programmed to be non-private (see “[Privacy Release Button](#)”), a button is assigned to a station that activates privacy on the CO lines and the intercom for that station. Privacy prevents other stations from breaking in on calls using common CO Line buttons. It does not prevent alternate point answer of transferred calls if the system is set for it. The privacy remains in effect until the button is pressed again, even if the user makes several other calls.

A Privacy button can be assigned to any station on Strata DK. By pressing the Privacy button, the station user prevents Privacy Override. Privacy remains in effect on that station until the user presses the Privacy button again to release privacy.

Please note that privacy features apply to CO lines and CO Line button appearances on telephones used in all Strata DK systems. Privacy does not apply to multiple DN appearances on telephones used in Strata DK systems because multiple DN buttons are always private.

Benefits

Adds flexibility to the system because selected users can make private calls, even when the system is programmed to be non-private. Organizations can use Privacy Override on CO lines for quick conferencing or for training purposes and still enable private, confidential calls.

Privacy Override

System Availability

Standard on Strata DK14/DK40i/DK424 with DKTs

Privacy Override enables a station user to break into any ongoing CO line call by pressing that CO Line button on the phone. Any number of stations can have the feature. If the system is programmed to be private, this feature overrides the system privacy.

When the overriding station breaks into a call, the conversing parties hear a single tone and a three-way conference is immediately in effect. No periodic warning tones are heard after the optional initial tone.

Note Privacy features apply to CO lines and CO Line button appearances on telephones. Privacy Override does not apply to multiple DN appearances on telephones. Multiple DNs are always private with no Privacy Override allowed.

Benefits

Provides a way to instantly contact any station that is engaged in a CO line conversation to deliver an important message.

Privacy Release Button

System Availability

Standard on Strata DK14/DK40i/DK424 with DKTs

All Strata DK CO lines are in private mode by default (see “[Privacy Button](#)”). Individual CO lines are changed to non-private and back to private by pressing the Privacy Release button while the CO line is selected. The telephone automatically reverts back to the private mode (Privacy LED turns OFF) after each non-private call.

A maximum of four parties, including the distant parties on the CO line, participate in a “non-private” call.

Note Privacy features apply to CO lines and CO Line button appearances on telephones. Privacy Release features do not apply to multiple DN appearances on telephones. DN buttons are always private.

Benefits

Users conveniently and easily release the privacy on a CO line when they want to set up a “quick conference.”

Private CO Lines

System Availability
Standard on Strata DK14/DK40i/DK424 with DKTs

All systems are programmed to enable certain CO lines to appear only on one station and can be accessed only by that station. This effectively provides a “private” CO line. If the station is in the Call Forward mode, calls on the private CO line are forwarded.

Benefits

Provides the privacy, prestige, and convenience of a private line to selected employees. Private lines ensure that a CO line is always available to the user. Private lines are also used to help a business manage costs by billing back the full cost of the private line to the user.

Pushbutton Dialing

System Availability

Standard on Strata DK14/DK40i/DK424
with DKTs

The dial pads on all Toshiba digital key telephones are pushbutton style. Electronic signals generated by the dial pad are neither DTMF nor rotary dial signals. On outgoing calls, the system converts the station signals to DTMF or rotary before they are outpulsed according to the requirements of the CO.

The DTMF receiver provides end-to-end signaling, and is required whenever devices, which send DTMF signals, are connected to standard telephone circuits in the system.

Benefits

Provides ease and convenience of a pushbutton telephone regardless of the serving CO.

Release Button

System Availability

Standard on Strata DK14/DK40i/DK424
with DKTs

A Release button can be programmed on a digital telephone. The user presses the Release button to disconnect an existing call and does not have to press the hookswitch. It puts the telephone into an idle state. For automatic off-hook selection, use the Release/Answer button.

Benefits

Provides convenient, quick and smooth disconnects from calls by eliminating the fumbling with the hookswitch. Users often waste time and become irritated when using the hookswitch to disconnect calls. They press it too quickly to send a clear disconnect signal and have to try several times to actually disconnect.

With one touch of the Release button, a user can conveniently, quickly and smoothly disconnect from a call. The Release button is especially useful in headset applications.

Release/Answer Button

System Availability

Standard on Strata DK14/DK40i/DK424
with DKTs

The Release/Answer button provides an efficient way to handle multiple incoming calls. A station user who is talking on a call can release and transfer or disconnect the active call, and automatically answer a new incoming call with Incoming Auto Selection. Calls can be received on the CO Line, Pooled Line, or DN buttons.

This provides convenient release and answer capabilities with the press of one button. The Release/Answer button is especially useful for telephones or Attendant Consoles that must answer calls in heavy traffic situations.

Benefits

Enables the answering of calls quickly and efficiently in heavy traffic applications. This feature enables users to streamline the call handling process with the touch of one button that disconnects or transfers the current call, and answers the next. Operators can process more calls and provide better service to callers.

Remote Retrieval of Held Calls

System Availability

Standard on Strata DK14/DK40i/DK424

Remote Retrieval of Held Calls enables any station user to retrieve a call that has been put on hold by another station by pressing a feature button or dialing an access code.

This feature is particularly useful if the call to be retrieved is held on a CO line that does not appear on the station from which it is retrieved.

If more than one call is on hold at a station, the lowest number CO line is picked up first. Also see [“Call Pickup”](#).

Benefits

Improves call handling by providing complete call retrieval flexibility. A user can easily pick up a call that was held at a different station without having to physically go to that station. Time is saved, and calls are handled promptly.

Repeat Last Number Dialed

System Availability

Standard on Strata DK14/DK40i/DK424

This feature enables a digital or electronic station to automatically redial the last number dialed from their station by selecting an outgoing line and pressing the Redial button or by dialing an access code. Digital key telephones have a fixed Redial button for automatic redialing of the last number dialed.

Benefits

Ensures accurate and speedy redial of the last number which reduces dialing errors and eliminated the wasted time involved in redialing a number that is busy or not answering.

Ringling Line Preference

System Availability
Standard on Strata DK14/DK40i/DK424

If an incoming CO, DID, or Tie line is ringing at a station, the station user who has this feature answers the line by simply lifting the handset or pressing the Spkr button. The station user is automatically connected to the line that is ringing, without having to press the specific line button for the call.

Benefits

Enables quick and convenient answering of calls because the user does not have to look at the line buttons or think about which line button to press.

Saved Number Redial

System Availability

Standard on Strata DK14/DK40i/DK424
with DKTs

A station user with this feature saves a dialed number for redial at a later time by pressing an optional feature button. The number is saved before the called number rings, during a conversation, or after the call has ended.

This feature is independent of the Repeat Last Number Dialed feature and enables the saved number to be redialed at any time by selecting a DN or CO line and pressing the Save button. The user can make other calls and then redial the saved number. The number is saved until the Save button is used to save another number.

Benefits

Saves a number for redialing at a later more convenient time even if additional calls have been made. The station user saves time because the number does not have to be looked up and redialed. Repeat Last Number Dialed feature cannot be used to redial the number because more calls have been made.

Speed Dial (SD) Button

System Availability

Standard on Strata DK14/DK40i/DK424 with DKTs and EKTs

Buttons on a digital key telephone can be assigned as Speed Dial (SD) buttons. Each button stores a pre-programmed telephone number, providing “one-touch” dialing for frequently called numbers. Telephone numbers can be up to 20 digits on Strata DK systems.

SD buttons also store feature sequences creating User Programmable Feature Buttons. Refer to the [“User Programmable Feature Buttons”](#). Each SD button that is programmed on a digital telephone reduces by one the number of station automatic dialing numbers available to that station.

There are the following types of SD:

- ♦ Station SD – Station users store their own personal telephone numbers on Station SD buttons. Each button uses one of the assigned 40 station speed dial number storage locations.
- ♦ System SD – A designated station user stores numbers for System SD buttons, which can be assigned to any digital or electronic telephone. For the number of available system speed dial numbers, see [“Tandem CO Line Connection \(Trunk-to-Trunk\)”](#) in the System Features section.
- ♦ Locked SD – SD buttons can also be used to store CO/Centrex/PBX feature access codes in system speed dial locations. Those system speed dial codes can then be assigned in system programming to a button on any digital telephone using the Flexible Button Assignment feature. When a SD button is used in this way, it is referred to as a “locked” SD button. The station assigned to port 00 or 000 is the only station that can program or change the numbers programmed for a “locked” SD button providing security and control.

Benefits

Provides instant, one-button access to personal speed dial numbers eliminating dialing errors and saving time used to look up frequently called numbers.

Timed Reminder

System Availability

Standard on Strata DK14/DK40i/DK424
with DKTs

A digital telephone station user can set five separate reminders on his/her station even if the digital telephone has no LCD. The reminder tone sounds at the preset time. The user hear a 30-second muted ring. Each reminder may be set to ring only once, or at the same time daily.

For expanded Timed Reminder capabilities with display information, see [“LCD - Timed Reminders”](#).

Benefits

Provides a convenient, built-in tone reminder system.

Toll Restriction Override Code Revision

System Availability

Standard on Strata DK14/DK40i/DK424

Two special codes can be defined to override toll restriction. Each code can have up to four digits. Access to these override codes can be assigned to individual employees as required. Any person who knows either code can override toll restriction at any station.

The toll restriction override check method is very sophisticated and makes it almost impossible for anyone to break the override code.

These codes can be changed from any station that is enabled to do so in system programming. They are changed by dialing a special feature code and entering the new override code. This makes it simple for selected executives to change the override codes without having to call the service company.

Benefits

Ensures that certain non-restricted users (such as the executives) can make calls from any telephone in the system and not be subject to the toll restriction on the station used to place the call.

User Programmable Feature Buttons

System Availability

Standard on Strata DK14/DK40i/DK424
with DKTs and EKTs

Enables digital telephone users to program their own flexible buttons to perform sequences of operation. The user uses the station speed dial function to dial features as well as station numbers or outside telephone numbers.

As many as 20 digits can be stored on a button, and fixed feature button functions (such as PDN, Intercom, Conference/Transfer, and Hold) can also be stored. In addition, several features can be linked together. For example, a user can program a button to place the call on hold, access intercom and dial a page access code, so that with one push of a button the user is ready to make an announcement.

In addition to being stored on speed dial buttons, feature sequences can also be stored in speed dial numbers.

Benefits

Enables fast and simple access to features because users don't have to remember or look up instructions or follow prompting instructions. Multi-step feature operation is stored and activated at the touch of one button.

Individual station users use flexible buttons to tailor their phones to fit their special needs. They can use access codes if they do not have buttons available.

Features

Station Features

The Strata AirLink Wireless system adds wireless telephone service to new or existing Private Branch Exchanges (PBXs) or key/hybrid telephone systems. There are two available configurations:

- ♦ Base Station Interface Adapter (BSIA) system that interfaces to Strata DK systems and many non-Toshiba systems using the standard telephone ports.
- ♦ RWIU system that interfaces to Strata DK16 and DK16e, DK40i, DK280, and DK424, using a proprietary RWIU Printed Circuit Board (PCB).

The Strata AirLink wireless systems operate in single building and campus environments in the 1920~1930 MHz bandwidth. This bandwidth is designated by the Federal Communication Commission (FCC) for unlicensed operation in the United States.

The Strata AirLink Standard wireless system has Base Stations, handsets, Base Station Interface Adapters (BSIAs) or controllers, and the Strata AirLink Manager software. The BSIAs interface with the standard analog telephone PCB (RSTU2) to support up to two Base Stations.

The Strata AirLink Digital wireless system has Base Stations and handsets, but interfaces directly to the Strata DK16, DK16e, DK40, DK40i, DK280, and DK424 using its own digital PCB (RWIU) instead of the BSIA. The card functions as a protocol converter between the Base Stations and the telephone system. It has four digital circuits that connect to four Base Stations using the industry standard RJ11 jack. Multiple RWIUs can be installed to increase the capacity.

System Components

[Figure 6](#) shows the external interface wireless telephone system connected to a PBX. Analog station ports in the PBX connect to the BSIA and provide a signal to the Base Stations. The Base Stations convert the analog signal to an RF signal for transmission to the handsets. The same lines can be connected to wired extensions for users that have both wireless and wired extensions.

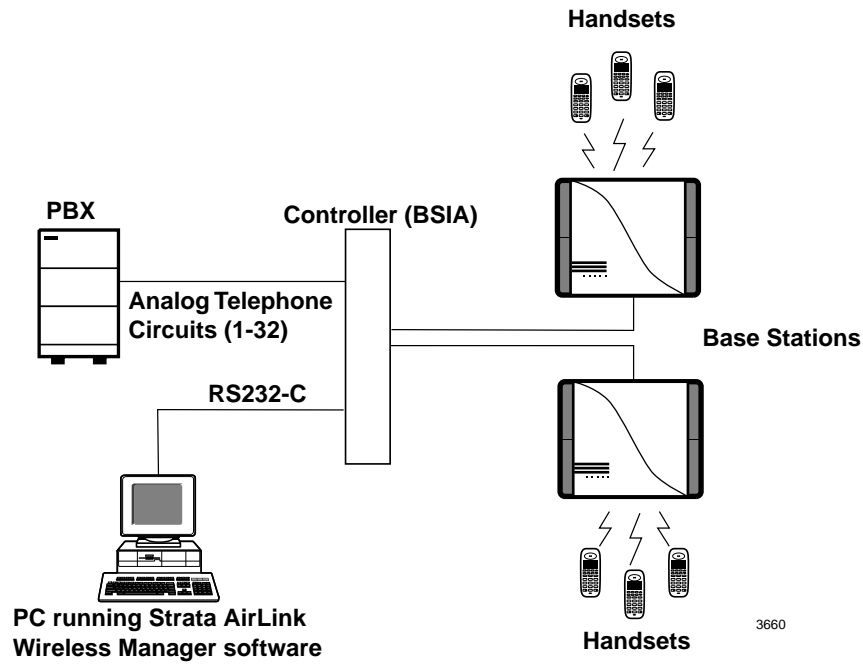

Figure 6 External Wireless System Components

Figure 7 shows the integrated wireless system interfacing to the PBX using the RWIU PCB that supports four Base Stations.

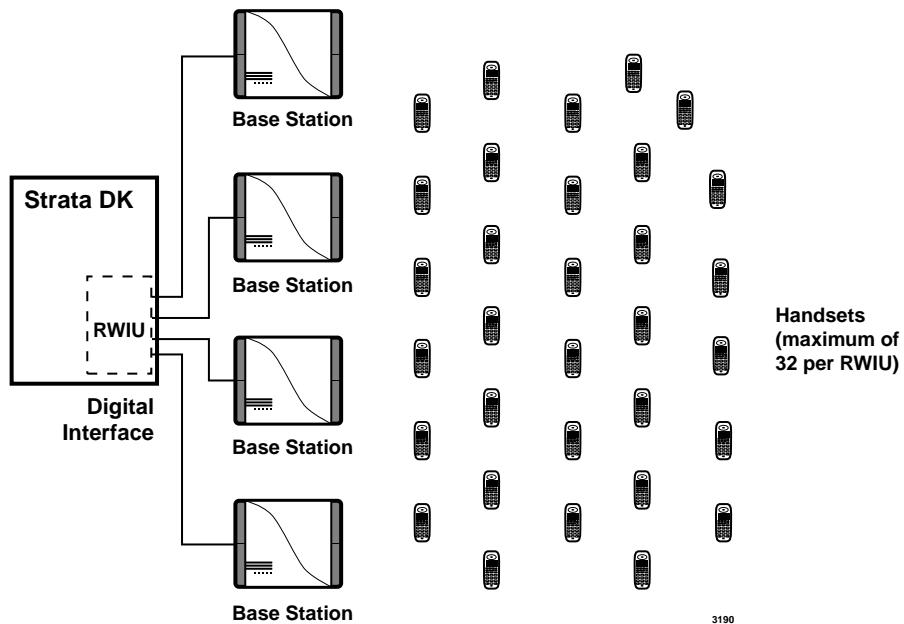

Figure 7 Integrated Wireless System Components

Base Station Interface Adapter (BSIA)

The BSIA interfaces the wireless system to the office telephone system. It supports up to two Base Stations and is designed for wall or rack mounting. Information stored in the BSIA assigns handsets to Base Stations and defines the handset feature operation.

The BSIA sends information about system operation and alarm conditions to a PC using its RS-232-C port and the Strata AirLink Manager software.

RWIU Interface Unit

The RWIU PCB functions as a protocol converter between the Base Stations on one side and the Strata DK system on the other. The RWIU is the “master” PCB, generating timing and synchronization signals and the WWIS PCB is the “slave.” The WWIS has four Base Station interface connectors. The PCBs have LEDs that indicate a continuous status of operation for both.

Base Stations

Base Stations (shown in Figure 8) have radio transmitters and receivers that handle communication with the handsets.

The Base Stations relay calls between the handsets and other telephones and trunks connected to the office telephone system. LEDs on the Base Station provide diagnostic information for System Administrators.

Each Base Station provides coverage for a particular area and supports eight simultaneous conversations.

In typical office environments, each Base Station, using four antennas for the best possible signal reception, has a broadcast range of up to 328 feet and supports an area of 320,000 square feet. To increase traffic capacity without interference, the Base Stations can be placed in the same coverage area (co-location).

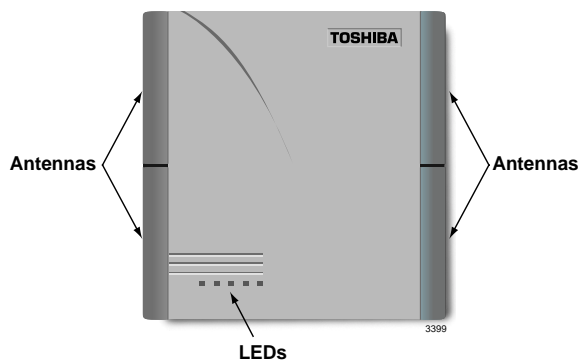

Figure 8 Wireless System Base Station

Wireless Test Stand

The Strata AirLink Wireless Test Stand easily determines proper Base Station positioning prior to permanent installation. The test stand is mobile, enabling quick identification of the best possible locations for each Base Station. It generates set frequencies for the handset to lock onto and verifies Bit Error Rate (BER) status.

Strata AirLink BSIA Manager Software

The Strata AirLink BSIA Manager software is a Windows 95 application that includes:

- ◆ Easy-to-use Desktop Toolbar for navigation
- ◆ Configuration Window for setting system parameters and handset features
- ◆ Status Window to view system alarms
- ◆ Upgrade icon for immediate upgrades to the BSIA and Base Stations

- ✦ Viewable or printable log files
- ✦ Online Help

PC Hardware and Software Requirements

Table 11 lists the minimum hardware and software that your PC must have to use the Strata AirLink BSIA Manager software.

Table 11 PC Hardware and Software Requirements

	Minimum	Recommended
Processor	386DX 33 MHz	486DX2 66 MHz
Hard Drive	1.5MB	3MB
RAM	4MB	8MB
Video	VGA	SVGA
Mouse	Any supported by Windows	Same
Floppy Drive	1.44 MB 3.5 inch	Same
Software	Microsoft Windows 3.1/3.11	Windows 95

Desktop Toolbar

When you open the Strata AirLink BSIA Manager software from its Program Group, the Desktop Toolbar displays (shown at the right).

Use this toolbar to easily configure the system, access the Status Window, upgrade the system, edit and save log files, access online Help, and exit the program. The toolbar can be placed anywhere on your desktop.

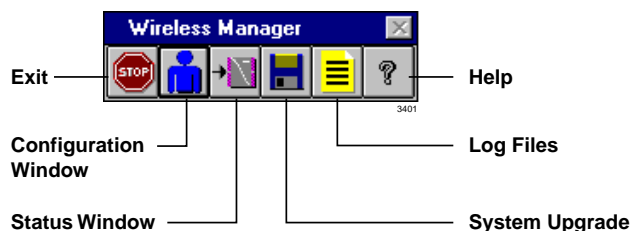

Configuration Window

The Configuration Window accesses the databases that set system parameters, user settings, and feature button sequences. The button sequences enable the handsets to use the office telephone system features.

Status Window

The Status Window, accessed from the Desktop Toolbar, gives you valuable system activity information. It is an excellent troubleshooting tool. You can check the status of Base Stations, lines, and calls. You can also clear critical alarms and make a software version inquiry.

Strata AirLink RWIU Manager Software

The Strata AirLink RWIU Manager software is a Windows 95 application that includes:

- ♦ Easy-to-use Desktop Toolbar for navigation
- ♦ Configuration Window for setting the system ID, handset IDs, time and date, and communication ports
- ♦ Status Window to view software versions, log messages, reset the Base Stations and/or the RWIU
- ♦ Software Upgrade Window for immediate upgrades to the RWIU and Base Stations

PC Hardware and Software Requirements

Table 12 lists the minimum hardware and software that your PC must have to use the Strata AirLink RWIU Manager software.

Table 12 PC Hardware and Software Requirements

	Minimum	Recommended
Processor	386DX 33 MHz	486DX2 66 MHz
Hard Drive	1.5MB	3MB
RAM	4MB	8MB
Video	VGA	SVGA
Mouse	Any supported by Windows	Same
Floppy Drive	1.44 MB 3.5 inch	Same
Software	Microsoft Windows 3.1/3.11	Windows 95

Desktop Toolbar

When you open the Strata AirLink RWIU Manager software from its Program Group, the Desktop Toolbar displays (shown at the right).

Use this toolbar to easily configure the system, access the Status Window, upgrade the software, activate UTAM, and exit the program. The toolbar can be placed anywhere on your desktop.

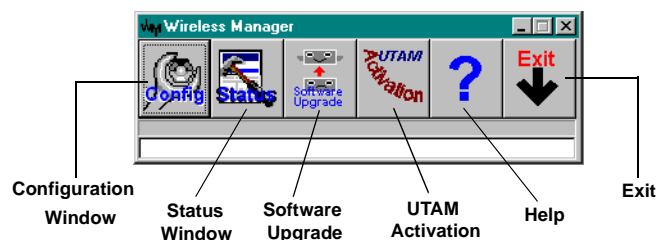

Handsets

The Strata AirLink wireless handset (Figure 9) is small, lightweight, easy to use, and operates the same in the integrated and external wireless system.

Feature access depends on the office telephone system. The System Administrator can provide information specific to the telephone system.

Electronic Serial Numbers (ESNs) are programmed into the handsets at the factory and are automatically configured the first time a call is made. They are unique to each handset.

There is a Liquid Crystal Display (LCD) for alphanumeric information and icons that report handset status. Table 13 briefly describes the functions of the LCD fields, fixed buttons, and icons.

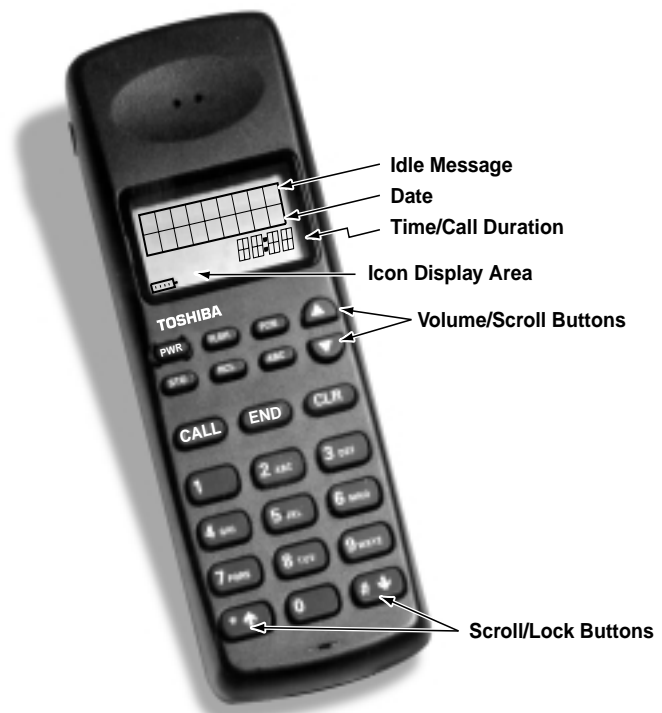







Figure 9 Strata AirLink Wireless Handset

Table 13 LCD Fields, Fixed Buttons, and Icons Descriptions

Handset		Description
LCD Fields	Idle Message	Displays an idle message.
	Date	Displays the current date.
	Time/Call Duration	Displays the call duration.
	Icon Display Area	Displays icons that represent different battery and handset conditions.
Fixed Buttons	PWR	Turns the power ON and OFF.
	FLSH	Performs hookflash functions.
	FCN	Enables features with the use of other buttons; for example, Call Forward, Transfer, Speed Dial, and Conference.
	▲	Increases listening volume and scrolls forward through menu options.
	▼	Decreases listening volume and scrolls backward through menu options.
	ABC	Toggles handset between alpha and numeric modes.
	RCL	Recalls numbers stored in memory.
STO	Stores Speed Dial numbers/names and the idle message.	

Table 13 LCD Fields, Fixed Buttons, and Icons Descriptions(continued)

	Handset	Description
	CALL	Places the handset off-hook to enable calling.
	END	Places the handset on-hook and exits from RCL , FCN , STO , and ABC modes.
	CLR	Erases one or more digits in the display.
	* ↑	Scrolls backwards through the Speed Dial list.
	# ↓	Scrolls forward through the Speed Dial list and locks/unlocks the dial pad.
	FCN+1 ¹	Places calls on Hold.
	FCN+2 ¹	Conferences or transfers calls.
	FCN+3 ¹	Retrieves messages.
Icons		Off-hook or ringing handset.
		Indicates battery strength—one bar is low and four is high.
		Indicates the currently configured ring volume.
	ABC	Indicates alpha mode—you can use the dial pad to enter letters in the display.
		Indicates signal strength.
		Indicates a message waiting. ¹
		Indicates that your handset is forwarded. ¹

1. Available in Strata DK systems only.

Charger Base

The handset comes with a charger base that has two slots (see [Figure 10](#)). The rear slot, for a spare battery, automatically starts its discharge function when it detects that discharging is necessary.

The front slot functions as a cradle for the handset and a charger for its battery. It provides rapid charging only.

The unit has LEDs that indicate battery status while charging. The LEDs flash and use the colors red, green, and amber to indicate different conditions.

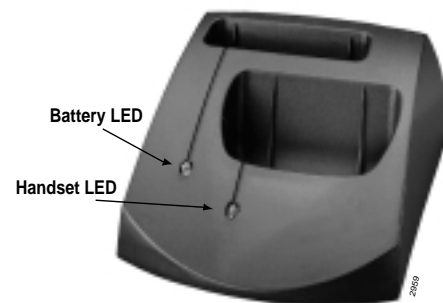

Figure 10 Charger Base

Handset Features

This section describes the specific handset features available to Strata AirLink Wireless handset users. The handset can also access the system and station features provided by the host telephone system.

FCN Feature Access

System Availability
Standard for the handset

Pressing the FCN button with other buttons enables access to office telephone system features, such as Automatic Call Back, Speed Dialing, and Call Forward. Some features require a few steps before you use the FCN button. For example, to establish a conference, you must be in conversation with one party and have another party on hold before you press FCN + 4.

Note Access to system features using the FCN button requires system programming and can vary depending on your office telephone system. Your System Administrator can provide information specific to your telephone system.

Benefits

Provides easy access to certain system features using the handset.

Flash Button

System Availability
Standard for the handset

The ordinary telephone hookswitch is located in the handset cradle of your telephone. The wireless telephone has a special button (FLSH) that flashes the hookswitch. The FLSH button enables a number of features.

Conferencing, Centrex, or behind PBX operation, which are CO line features, require “flashing a CO Line” to enable Centrex/PBX access codes or extension numbers.

Benefits

Convenient way to make a series of CO calls or redial a busy number. The Flash button enables the user to easily disconnect and reconnect to the same CO line with one touch of a button.

When the system is installed behind a PBX, the features that require a “flash” to operate can be easily accessed, enabling stations to function more fully and take advantage of the PBX features.

Lock/Unlock the Dial Pad

System Availability
Standard for the handset

You can lock the handset dial pad to avoid the accidental pressing of buttons. The dial pad automatically unlocks when you receive an incoming call and then relocks when the call ends.

Benefits

Prevents inadvertent calling or making busy of the handset.

Menu Operation

System Availability
Standard for the handset

You can configure some aspects of handset operation using the Liquid Crystal Display (LCD) menu, such as:

- ◆ Auto Answer
- ◆ Change Idle Message
- ◆ Click Volume
- ◆ Del All Speed Dial Numbers
- ◆ Del Last Number Dialed
- ◆ Display Contrast
- ◆ Display Test Option
- ◆ Ringer Type Option
- ◆ Ringer Volume
- ◆ Time Format

Benefits

Provides flexibility according to individual user requirements.

Mute

System Availability
Standard for the handset

The handset has two types of mute:

- ◆ Voice – the handset microphone temporarily disconnects, so the other party cannot hear you.
- ◆ Ring – the ringer temporarily disconnects during an incoming call without affecting the call.

Benefits

Enables the station user to control what the other party hears during conversations (voice mute) or ensures that others are not disturbed in meetings or in the immediate area of the handset (ring mute).

Speed Dial

System Availability
Standard for the handset

Your handset stores 70 speed dial numbers, 10 of which can be dialed by pressing one button. You can also assign memory locations or names. Before you store any numbers or names, you need to know how many locations are available.

You can easily find available locations, search for a number or name, program a pause or “wait.”

Benefits

Saves time when looking up and dialing telephone numbers. It also avoids costly long distance dialing errors.

Volume Adjustment

System Availability
Standard for the handset

The Strata AirLink wireless handset has 13 volume settings that adjust the calling party voice level. To adjust the volume, press the scroll up or down button until you reach the level you want.

Benefits

Sets the volume to individual user requirements.

The Strata PC Attendant Console is optional on Strata DK424 systems with RCTUBA/BB, RCTUC/D, or RCTUE/F processors and unavailable on DK424 RCTUA, DK40i, or DK14 systems. It combines the DK424 with easy-to-use Microsoft® Windows®. Attendants can process a heavy load of incoming calls quickly and efficiently using the PC Attendant Console. [Figure 11](#) shows the components of the PC Attendant Console.



Figure 11 PC Attendant Console

Features

The console's streamlined features can be operated by clicking the mouse on screen buttons or using equivalent keys on the keyboard. This enables Attendants to use whichever method is most comfortable for them. The mouse and keyboard can be used together interchangeably.

The monitor displays detailed call information including:

- ♦ Call identification
- ♦ Calling/called numbers and name indications
- ♦ Answer prompting
- ♦ Call waiting count
- ♦ Hold timer
- ♦ Advisory messages and much more

[Figure 12](#) shows the call information fields in the Main Display screen.

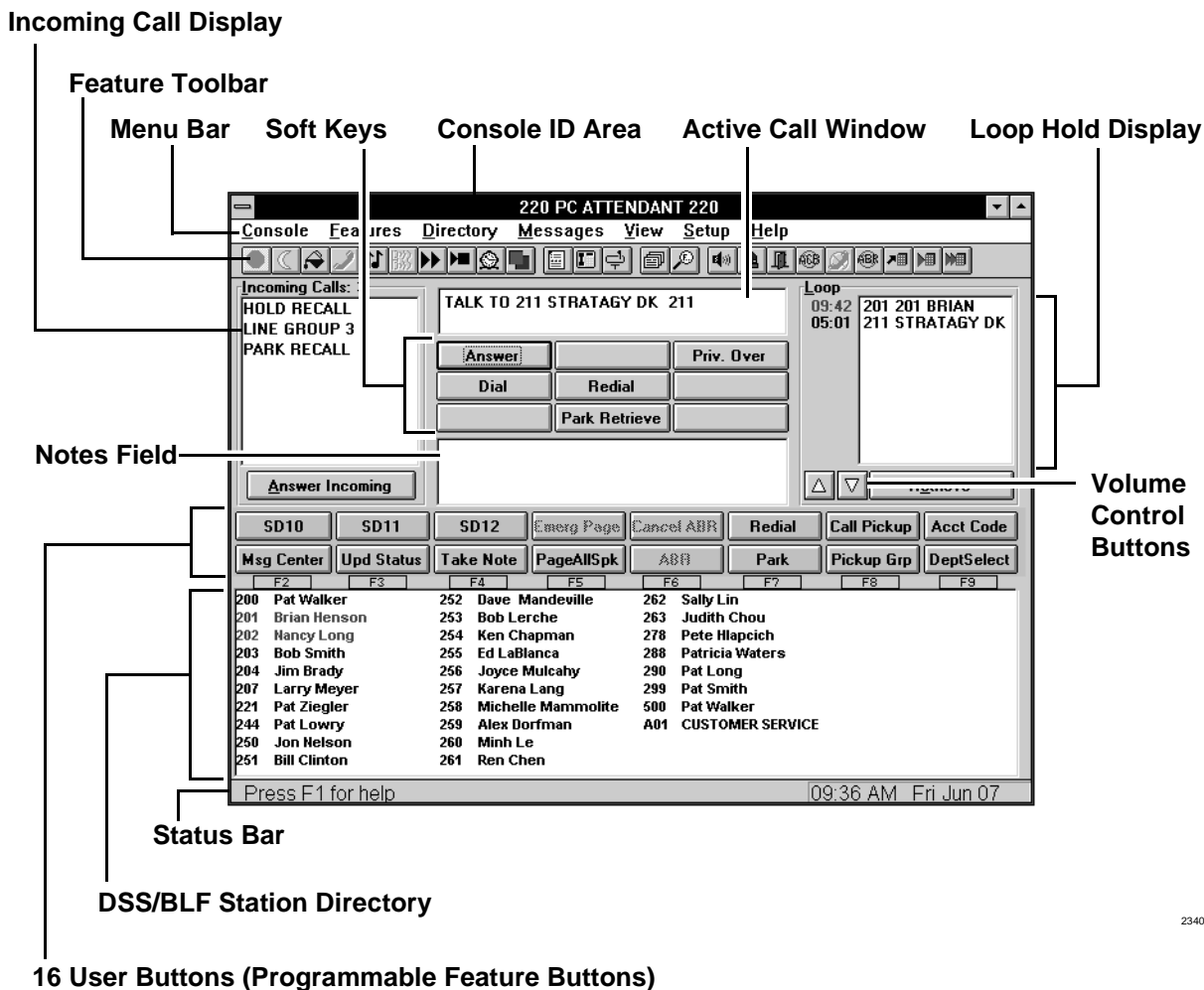

2340

Figure 12 Main Display Screen Layout

The display also provides a name/extension directory, an outgoing Speed Dial directory, and a Busy Lamp Field (BLF), which enables the Attendant to see station status at a glance. Various colors indicate different statuses or conditions, making them more distinguishable to the Attendant. Call progress messages and Soft Key prompts are displayed also, making the PC Attendant Console very easy to use.

Other powerful features include Call Answer Priority and Queuing, Direct Station Selection (DSS), DTMF Tone Signaling from the dialpad, Emergency Calling, flexible programmable buttons, Loop Hold display with timer, and headset/handset operation with volume control.

The PC Attendant Console also enables efficient outgoing calling using DTMF and flash signaling, individual trunk access or trunk group access by programmable button, and system Speed Dial access.

These features make outgoing calls easier and more functional on the PC Attendant Console than on many Attendant Consoles provided by the competition. The features are described in detail later in this section. It also uses many of the station features detailed in the Station Features chapter.

The PC Attendant Console is sold as a kit that includes:

- ♦ RATI interface
- ♦ RATHC handset/cradle
- ♦ Custom keyboard (see [Figure 13](#))
- ♦ Toshiba-proprietary software
- ♦ User guide

Note The RATU and PC are not included in the kit.

The RATI interface connects to an RATU card in the DK424 system cabinet via a single pair of wires.

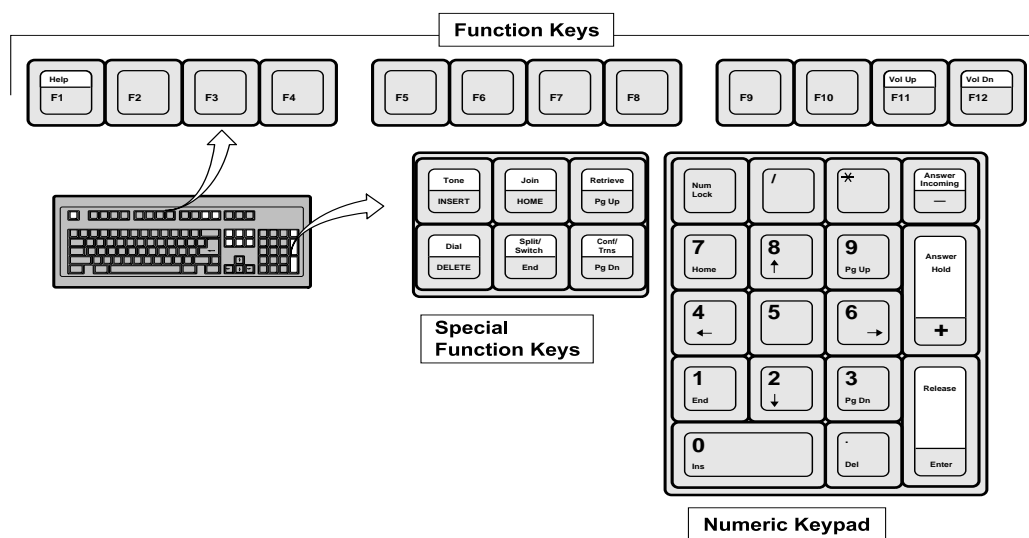

1306

Figure 13 Custom Keyboard Layout

Operation

The Strata PC Attendant Console software runs as an application within Windows on the PC. It is recommended the PC be dedicated to the console function.

Other applications can also run simultaneously on the same PC. The Attendant can toggle from Attendant Console mode and enter some other application. If a call is received while in another application, the PC can automatically switch to Attendant Console mode to handle the incoming call. When incoming traffic is light, the Attendant can quickly and easily toggle back and forth between another application and Attendant Console mode at the touch of a keyboard button.

PC Requirements

The PC is customer supplied and should have the following recommended minimum PC requirements:

- ✦ Pentium® processor, 100 MHz
- ✦ 16MB RAM
- ✦ 200MB drive (PC Attendant Console uses about 5MB)
- ✦ 2 COM ports (one for PC Attendant Console and one for general use)
- ✦ 1 printer port
- ✦ SVGA color monitor
- ✦ Mouse
- ✦ Windows 95 (recommended) or Windows 3.1
- ✦ Windows Graphics Accelerator (recommended)

Windows PC Operation

The Strata PC Attendant Console software runs as a Windows-based application on a PC. The commands operate and look like other Windows applications. It is recommended the PC be dedicated to the console function, but other applications can run simultaneously with the console software.

The PC toggles from Attendant Console mode to other applications. If a call is received while in an application, the PC automatically switches to Attendant Console mode. When calling traffic is light, the Attendant can quickly and easily toggle back and forth between applications and the Attendant Console mode.

Operating in a Windows environment maximizes the use of the computer as a multi-purpose workstation during non-peak traffic periods. The console application is easy to learn and use, because its commands look and operate similar to other Windows applications.

Applications

In DK424 answer position applications, you can offer flexibility by providing a choice that meets the specific customer requirement. Choose between add-on modules, DSS consoles, or Attendant Consoles to best serve their needs. Complemented by ACD, Auto Attendant and Voice Mail, you can offer the most complete call answering solution available today.

Attendant Consoles process calls faster than DSS consoles and add-on modules. [Table 14](#) describes guidelines for choosing which equipment to use.

Table 14 Comparison of Attendant Consoles, DSS Consoles, and Add-on Modules

Use the Attendant Console When:	Use the DSS Console When:	Use the Add-on Module When:
There is a very high volume of incoming call traffic.	The volume of incoming call traffic is moderate.	Smaller departmental answer positions are needed.
Too many stations appear on a DSS console – the directory display is a more efficient tool.	The Attendant needs individual button access to all CO Lines.	20 or 40 DSS/BLF buttons are sufficient.
Multiple Attendants simultaneously share the Call Answering function. Multiple consoles work well together, automatically sharing the load of incoming calls on a call-by-call rotation basis.	Simple BLF display and DSS transfer are the main applications.	A DKT needs more buttons for general feature use.
Many calls of different types (incoming, transfers, recalls, etc.) are received by the Attendant.		Additional station ports may not be available for DSS console connection. Add-on modules share the station port of the attached DKT and do not require their own station port.
Answer prompting is needed to provide the Attendant important information to answer properly, such as multiple product lines, departments, or tenants.		
Features are required which the DSS console does not provide, for example, Load Sharing, Answer Priority, Emergency Calls, Overflow, and Dialing-by-Name.		
A multi-purpose work station is required to provide a high level of answered calls and other processing capabilities in a Windows PC environment.		

PC Attendant Console Features

This section describes the specific console features available to PC Attendant Console users.

Answer Button

System Availability

Optional on Strata DK424 with RCTUBA/BB, RCTUC/D, or RCTUE/F processors

Unavailable on Strata DK14/40i/DK424 with RCTUA processor

Pressing the Answer button automatically answers any incoming call regardless of the type (incoming CO, internal DN, transferred, recall, etc.). Multiple calls are automatically queued and answered on a first-in, first-out basis, or according to the priority defined by the user with the “Answer Priority” feature.

Benefits

Enables quick and efficient answering of calls by clicking or pressing one button. The Attendant does not have to find and select the ringing line. This greatly streamlines the process and reduces Attendant stress in high-volume applications.

Answer Priority

System Availability

Optional on Strata DK424 with RCTUBA/BB, RCTUC/D, or RCTUE/F processors

Unavailable on Strata DK14/40i/DK424 with RCTUA processor

Answer Priority enables the Answer button to queue and answer multiple incoming calls in a priority sequence. The priority sequence is programmable except for emergency calls, which are always the highest priority. The program default priority sequence (highest to lowest) is Park Orbit Recall, Transfer Recall, Hold Recall, Transferred to “0” Call, Incoming CO Line call, Internal “Dial 0” Attendant Call, and Internal to Attendant Directory Number call.

Benefits

Ensures that the most important calls are answered first without the Attendant having to decide which call should be answered. This makes it easy for the Attendant and streamlines the process prioritizing all incoming calls.

Answer Prompting

System Availability

Optional on Strata DK424 with RCTUBA/BB, RCTUC/D, or RCTUE/F processors

Unavailable on Strata DK14/40i/DK424 with RCTUA processor

Answer Prompting by CO Line or Dialed Number Identification Service (DNIS) information makes it easy for the Attendant to answer calls appropriately for different product lines, departments, tenants, etc. The CO line identification or DNIS information causes the ringing console's screen to display a prompted greeting up to 100 characters long, according to the line called or number dialed. Programming DID lines to use DNIS routing enables for personalized answering of DID calls.

Benefits

Answering for multiple tenants, product lines, or departments is easy for the Attendant who only has to look at the screen to see how to greet each caller. This not only makes appropriate answering easy, but provides a professional image to callers.

Attendant Conference Setup

System Availability

Optional on Strata DK424 with RCTUBA/BB, RCTUC/D, or RCTUE/F processors

Unavailable on Strata DK14/40i/DK424 with RCTUA processor

Attendant Conference Setup enables the Attendant to setup a conference call with up to four members. Conference members can be either another console, stations, or CO lines. The conference can be originated by the Attendant or requested by a station user or outside party.

Benefits

Provides convenience to station users who can request the Attendant to set up a conference call.

Auto Day/Night Mode Switching

System Availability

Optional on Strata DK424 with RCTUBA/BB, RCTUC/D, or RCTUE/F processors

Unavailable on Strata DK14/40i/DK424 with RCTUA processor

Auto Day/Night Mode Switching enables automatic switching of the DK424 system between Day, Day 2, and Night modes according to the time of day and day of the week. Parameters are programmable by the console Attendant.

This provides automatic mode switching without having to manually press the Night Transfer button. This automatic mode switching feature is only available with a PC Attendant Console installed, and is not a standard system feature of the DK424.

Benefits

Provides automatic switching between day and night modes. No one has to remember to push the Night button to place the system into Night mode at the end of the business day, because the system clock sends the appropriate commands to the DK424 to change the modes.

Auto Dialing

System Availability

Optional on Strata DK424 with RCTUBA/BB, RCTUC/D, or RCTUE/F processors

Unavailable on Strata DK14/40i/DK424 with RCTUA processor

The PC Attendant Console has a name/number search function that automatically dials the number of the matched name/number when the Auto Dial option is on. If Auto Dial is off or no match is found, the Attendant can still use the directory and press a button to call the party or enter a number to be dialed.

The Attendant can call anyone listed in the directory by typing their name (first, last, or both). A directory listing is displayed and continually updated as characters are entered until a match is found. If several entries in the listing are similar, the use of the up and down arrow keys allow a specific name to be called or have a call transferred to.

Benefits

Facilitates quick and easy call processing, primarily for call transfer. The Attendant can quickly dial a desired party by a name search, making number finding easy.

Busy Lamp Field (BLF)

System Availability

Optional on Strata DK424 with RCTUBA/BB, RCTUC/D, or RCTUE/F processors

Unavailable on Strata DK14/40i/DK424 with RCTUA processor

The BLF on the screen displays the busy/idle status of stations so the Attendant can see who is busy or idle at a glance. The BLF data is displayed in the directory area of the screen either with or without station users' names. The choice of display options is set by the console Attendant.

Benefits

Enables quick identification of station status (busy and idle) and provides faster service. The Attendant can immediately inform the caller that their party is not available or route the call to another station. It saves the Attendant time by only handling the call once, rather than a second time if it recalls after being transferred to a busy station.

Call Waiting Count

System Availability

Optional on Strata DK424 with RCTUBA/BB, RCTUC/D, or RCTUE/F processors

Unavailable on Strata DK14/40i/DK424 with RCTUA processor

This feature displays, on screen, the number of calls in the answer queue. The list is continuously updated for the Attendant.

Benefits

Facilitates fast call processing by activating Call Overflow or notifying someone that an additional Attendant is needed during peak calling periods because it lets the Attendant know when call traffic is getting too heavy for efficient handling.

Color CRT Display

System Availability

Optional on Strata DK424 with RCTUBA/BB, RCTUC/D, or RCTUE/F processors

Unavailable on Strata DK14/40i/DK424 with RCTUA processor

Console text information is displayed on the monitor screen in full color. Various colors indicate different status of conditions, making them more distinguishable to the Attendant.

Benefits

Makes certain features and status of conditions stand out to the Attendant, because they are in color. Many of the colors are similar to other Windows applications. This makes the console easier to use for Attendants who are familiar with the standard Windows environment.

Dial “0” for Attendant

System Availability

Optional on Strata DK424 with RCTUBA/BB, RCTUC/D, or RCTUE/F processors

Unavailable on Strata DK14/40i/DK424 with RCTUA processor

Up to four Attendant Consoles can be installed per system, and this feature enables a user to call any available console by simply dialing “0”. The system routes their call to any available Attendant. To call a specific console, dial the console directory number.

Benefits

Enables automatic routing of calls to any available Attendant. Station users who want to reach an Attendant only have to dial “0;” they don’t have to know the DN. In a multiple console application, they do not have to keep dialing different attendants until they reach one that isn’t busy.

Dial Outside Number for Station User

System Availability

Optional on Strata DK424 with RCTUBA/BB, RCTUC/D, or RCTUE/F processors

Unavailable on Strata DK14/40i/DK424 with RCTUA processor

The Attendant can access a CO line and dial an outside destination number for a station user. To perform this operation, the Attendant must be in the talking state with either a station user, an outside caller, or a caller on an incoming Tie trunk.

Benefits

Provides convenience and saves time for station users.

Direct Station Selection (DSS)

System Availability

Optional on Strata DK424 with RCTUBA/BB, RCTUC/D, or RCTUE/F processors

Unavailable on Strata DK14/40i/DK424 with RCTUA processor

The Attendant can click on the station DN on the internal directory screen to perform direct station calling or transfer operation.

Benefits

Provides rapid and easy DSS calling, because the DN and name directory is on-screen. This provides the convenience and functionality of having a DSS module with the Attendant Console.

Directory Display and Dialing

System Availability

Optional on Strata DK424 with RCTUBA/
BB, RCTUC/D, or RCTUE/F processors

Unavailable on Strata DK14/40i/DK424 with
RCTUA processor

The directory listing area of the screen can display both names and DNs of internal station users. The Attendant can point and click on a name or DN, or use the keyboard to automatically dial the number. These may be accessed using Name Dialing or Department Dialing.

The directory includes each employee's name and DN. The directory display also includes busy/idle status of each name and/or DN. A scroll bar enables the Attendant to quickly scan all names in the directory listing. This information facilitates quick and easy call processing, primarily the transfer of incoming calls.

Benefits

Enables quick recognition of who is busy or idle and makes it easy to find requested employee names and/or DNs. It facilitates quick and easy call processing, primarily the transfer of incoming calls.

DTMF Tone Signaling

System Availability

Optional on Strata DK424 with RCTUBA/BB, RCTUC/D, or RCTUE/F processors

Unavailable on Strata DK14/40i/DK424 with RCTUA processor

The Attendant Console can generate DTMF tones from the dial pad to signal external devices such as voice mail, auto attendants, and answering machines on outgoing calls. This makes the Attendant Console efficient to use for both outgoing and incoming calls.

Both the Strata DK424 and the PC Attendant Console work with DTMF or dial pulse CO lines. The Attendant can change the CO line out-dialing signal mode from Dial Pulse to DTMF by clicking or pressing a button.

Benefits

Saves inconvenient use of another station to make outgoing calls by the Attendant. The Attendant can use the console for all types of outgoing calls, including those calls that require tone responses to external devices.

Emergency Calls

System Availability

Optional on Strata DK424 with RCTUBA/BB, RCTUC/D, or RCTUE/F processors

Unavailable on Strata DK14/40i/DK424 with RCTUA processor

Emergency Calls from internal stations to an Attendant Console always receive the highest answer priority. They have priority over the first in, first out or priority sequence established in programming. Emergency calls are initiated by station users by dialing a special number. They display on the screen in the incoming call area. If the call is placed on hold, the hold time appears in red to highlight this call for easy identification and retrieval.

Benefits

Enables station users an immediate way to get through to the Attendant. This is very important in emergency situations or anytime a station user needs priority access to the Attendant.

Emergency Page

System Availability

Optional on Strata DK424 with RCTUBA/BB, RCTUC/D, or RCTUE/F processors

Unavailable on Strata DK14/40i/DK424 with RCTUA processor

An Attendant Console equipped with an assigned Emergency Page button can page the All Call Telephone Page Group. The page sounds over the speakers of all idle telephones in the All Call Page Group, but does not sound over the external paging speakers. An Emergency Page pre-empts an existing page connection.

Benefits

Provides quick and easy access to station paging, either for emergency situations or anytime an announcement needs to be made. This feature also provides more private paging than external speaker paging, since Emergency Page goes only through telephone speakers. This is important if the page desires not to alarm customers or others in the general area.

Employee Profile Information

System Availability

Optional on Strata DK424 with RCTUBA/
BB, RCTUC/D, or RCTUE/F processors

Unavailable on Strata DK14/40i/DK424 with
RCTUA processor

By typing a name (first, last, or both) or a directory number, the console Attendant can display a complete profile for an employee. A special search by department can also be used to direct a caller to the appropriate person available to handle the call. Calls for employees not on-site can have information displayed on how they can be reached, or the Attendant can use the Transfer to Voice Mail feature to allow callers to leave a message for these employees who are not available for call transfer.

Benefits

Provides useful information about employees and assists proper alternate routing of calls. This enables the Attendant to provide better service to callers.

Feature Online Help

System Availability

Optional on Strata DK424 with RCTUBA/BB, RCTUC/D, or RCTUE/F processors

Unavailable on Strata DK14/40i/DK424 with RCTUA processor

Feature Online Help provides feature user instructions at the touch of a button or click of the mouse. This functions the same as other Windows PC applications. Online help provides information that is more detailed than routine feature prompting Soft Key instructions, but less detailed than the examples and instructions contained in the PC Attendant Console User Guide. Online Help is context oriented, providing information for the operation at hand on the console. Help can also be accessed using a table of contents or word search function.

Benefits

Makes the console easy to use by providing a quick and simple way of looking up needed information. Also, the online help function of the PC Attendant Console is similar to other Windows applications. This makes the PC Attendant Console easier to use for Attendants familiar with the standard Windows environment.

Feature Prompting with Soft Keys

System Availability

Optional on Strata DK424 with RCTUBA/BB, RCTUC/D, or RCTUE/F processors

Unavailable on Strata DK14/40i/DK424 with RCTUA processor

Feature prompting with Soft Key operation provides access to various console features. On-screen instructions and Soft Key functions and choices change according to the state of the Attendant Console, making the console easy to use.

Examples:

- ◆ Sending a message waiting indication to a station
- ◆ Breaking into an ongoing conversation
- ◆ Performing a transfer, conference, or voice page

Benefits

Makes call processing quicker and more efficient. Attendants are not intimidated by sophisticated features and can use them simply by following the instructions on the screen.

Flexible Programmable Buttons

System Availability

Optional on Strata DK424 with RCTUBA/BB, RCTUC/D, or RCTUE/F processors

Unavailable on Strata DK14/40i/DK424 with RCTUA processor

The console has 16 buttons on the display screen that can be programmed by the Attendant with a variety of feature assignments, trunk access, or as Incoming Call (In) buttons.

Benefits

Provides customization by the Attendant. Commonly used functions can be programmed on flexible buttons to provide one-touch access to these features, making the console easy and efficient to use.

Headset Operation

System Availability

Optional on Strata DK424 with RCTUBA/BB, RCTUC/D, or RCTUE/F processors

Unavailable on Strata DK14/40i/DK424 with RCTUA processor

In addition to the handset, the console can be used with a headset. The headset can be plugged into the Attendant Console Interface Unit (RATI).

Benefits

Provides both comfort and convenience to the Attendant. The Attendant does not end the day with a sore ear. Both hands are free to operate the keyboard and mouse.

Hold Button

System Availability

Optional on Strata DK424 with RCTUBA/BB, RCTUC/D, or RCTUE/F processors

Unavailable on Strata DK14/40i/DK424 with RCTUA processor

Pressing or clicking the Hold button places the current call on hold. The loop hold display area on screen shows held calls waiting for assistance.

A reminder note can be entered for a call with the name field displayed in the loop hold. This can be used to remind the Attendant who is holding or who they are holding for (see the Reminder Notes feature for more details).

The amount of time each call has been on hold is also displayed. If the call is not answered within a preprogrammed time period, the Attendant is reminded by a ring indicator and the recall information is moved from the loop hold display area to the incoming call display area on the screen.

The Attendant can operate with Auto Hold, which automatically places an existing CO line or internal call on hold (when another call is answered) or the dialing process is started.

Benefits

Provides customized functionality that helps the Attendant know the status of holding calls. The timer display serves as a reminder of calls needing attention, so the Attendant can provide better service to callers.

Hold Timer Display

System Availability

Optional on Strata DK424 with RCTUBA/
BB, RCTUC/D, or RCTUE/F processors

Unavailable on Strata DK14/40i/DK424 with
RCTUA processor

The Hold Timer Display shows the amount of time each call has been on hold. This information is shown in the loop hold display area on screen. This serves as a reminder for the Attendant, ensuring that the held calls are not be ignored or forgotten. If the call is not answered within a preprogrammed time period, the call is recalled with a ring indication in the incoming call display area on the screen. Also, the color indicates whether the call is on Hard Hold, Consultation Hold, Supervised Hold, or Emergency Call Hold.

Benefits

Serves as a reminder of calls needing attention, so the Attendant provides better service to callers. The recall function provides an automatic reminder so holding callers are not be forgotten.

Incoming Call Identification

System Availability

Optional on Strata DK424 with RCTUBA/BB, RCTUC/D, or RCTUE/F processors

Unavailable on Strata DK14/40i/DK424 with RCTUA processor

Incoming Call Identification provides selective answering of all categories of calls to the Attendant (internal DN, transferred, park recall, hold recall, transfer recall, emergency, Attendant, and incoming CO for all 16 CO line groups). Selecting and answering the desired ringing call in the incoming call display area, instead of using the Answer button to answer the next call in order, enables the Attendant to specifically answer a certain type of call and override the FIFO or priority order established by the Answer button and the Answer Priority feature.

Benefits

Provides better service to priority calls or calls that have been waiting a long time, because the Attendant has total control of call handling. The Attendant decides which call to answer and selects by type.

Incoming Call Statistics

System Availability

Optional on Strata DK424 with RCTUBA/BB, RCTUC/D, or RCTUE/F processors

Unavailable on Strata DK14/40i/DK424 with RCTUA processor

Incoming call statistics are collected by the PC on incoming calls received at the console. Information included is number of calls received per hour, total talk time (in seconds) per hour, total waiting time (in seconds) in queue per hour, and maximum number of calls in queue each 15-minute interval. The data is stored on disk for display or printing. This information can be displayed on the console screen or sent to an attached printer from selections available on the Menu bar.

The call statistics information can be displayed or printed for any of the following time periods: hourly, daily, weekly, or monthly (up to 2 months data stored). The top of the display/report indicates the time frame used to compile the information.

This built-in capability is only designed to collect a few basic statistics. A separate, more complete Call Accounting application would be required for more extensive data collection and reporting. For example, the console can send the data to a separate call accounting application also resident on the same computer.

If the PC is running a separate call accounting application, in addition to the Attendant Console application, the PC can temporarily exit Attendant Console mode and enter Call Accounting mode using the Windows Alt-Tab command. The Attendant can easily toggle back and forth between the call accounting application and the Attendant Console application using Alt-Tab on the keyboard. If a call rings to the console when the PC is in Call Accounting display mode, an interrupt capability may or may not immediately switch back to console mode to answer the call, depending upon the setting of the Auto Incoming option.

Benefits

Evaluates traffic patterns and call answering requirements, so a more expensive call accounting package is not required for simple statistical gathering applications.

Interposition Call Transfer

System Availability

Optional on Strata DK424 with RCTUBA/BB, RCTUC/D, or RCTUE/F processors

Unavailable on Strata DK14/40i/DK424 with RCTUA processor

Interposition Call Transfer enables calls to be transferred from one Attendant Console to another, as well as transferring a call to a station.

Benefits

Enables one console to transfer a call to another console with a simple and streamlined procedure.

Join Button

System Availability

Optional on Strata DK424 with RCTUBA/BB, RCTUC/D, or RCTUE/F processors

Unavailable on Strata DK14/40i/DK424 with RCTUA processor

The Join button enables the Attendant to connect an existing call with either an outside held party or an internal station. Rather than transferring the call, the Attendant presses the Join button to create a temporary conference from which the Attendant can then drop out.

Benefits

Ensures that two parties connect before dropping out of the conversation. This is sometimes more appropriate than using transfer, since the Attendant can provide more personalized service.

Keyboard or Mouse Operation

System Availability

Optional on Strata DK424 with RCTUBA/BB, RCTUC/D, or RCTUE/F processors

Unavailable on Strata DK14/40i/DK424 with RCTUA processor

Keyboard or mouse operation is available. Most functions of the PC Attendant Console can be operated either from clicking the mouse on screen buttons or pressing equivalent buttons on the keyboard. This enables Attendants to use whichever method is easiest for them. The mouse and keyboard may be used together interchangeably.

Benefits

Enables the most comfortable use of each individual Attendant Console – either by using the keyboard or the mouse for operations. Most Attendants use a combination of both the keyboard and the mouse for optimum efficiency and ease of use.

Load Sharing

System Availability

Optional on Strata DK424 with RCTUBA/BB, RCTUC/D, or RCTUE/F processors

Unavailable on Strata DK14/40i/DK424 with RCTUA processor

In a multiple console application, Load Sharing distributes incoming calls among available Attendant Consoles (up to four) on a call by call rotation basis. This is better than ringing all calls to all consoles. Individual Attendants only get their fair share of calls and answer only those ringing at their console. The Attendants also have other features such as Call Pickup, overflow, etc. to handle calls during heavy traffic periods.

Benefits

Provides the most efficient way of handling calls among multiple consoles by enabling an even distribution of calls. Along with other features, it provides methods of handling calls whenever an Attendant is tied up with a long call.

Loop Hold Display

System Availability

Optional on Strata DK424 with RCTUBA/BB, RCTUC/D, or RCTUE/F processors

Unavailable on Strata DK14/40i/DK424 with RCTUA processor

The loop hold display area on screen shows held calls waiting for assistance, either on a supervised or released loop basis. Supervised loop operation retains a transferred call in the loop display area, enabling the Attendant to visibly monitor it, or re-enter the conversation. Release loop operation briefly displays the held call in the loop display area, while it is being transferred and until it is answered by the station receiving the transferred call, at which time it disappears from the loop hold display area.

A reminder note can be entered for a call with the name field displayed in the Loop Hold. This can be used to remind the Attendant who is holding or who they are holding for (see the Reminder Notes feature for more details).

The amount of time each call has been on hold is also displayed in the loop hold area. If the call is not answered within a preprogrammed time period, the call is recalled with a ring indicator, and the recall information is shown in the incoming call display area on the screen.

Benefits

Provides the status of holding calls to the Attendant. The timer display serves as a reminder of calls needing attention, so the Attendant can provide better service to callers. The recall function provides an automatic reminder so the holding callers are not forgotten.

Message Center

System Availability

Optional on Strata DK424 with RCTUBA/
BB, RCTUC/D, or RCTUE/F processors

Unavailable on Strata DK14/40i/DK424 with
RCTUA processor

The Attendant can type a message for anyone entered into the directory by entering the message database from the keyboard. When a message is entered, it automatically sets the message light at the receiving message station. The station user can press the Msg button to call the Attendant that has the message. If the station is an LCD telephone, the message to call the Attendant is displayed on the LCD. The Attendant can display a list of messages for the caller and read them back.

Messages can be taken for any person entered into the directory of the Attendant Console. By entering important guests into the directory, messages can be taken for visitors as well as employees.

Benefits

Provides a message center capability in applications not using voice mail, or situations in which messages are not generated from a telephone call. Specialized message centers for guests can be set up for functions such as training seminars, client visitations, etc.

Multitasking

System Availability

Optional on Strata DK424 with RCTUBA/BB, RCTUC/D, or RCTUE/F processors

Unavailable on Strata DK14/40i/DK424 with RCTUA processor

The Strata PC Attendant Console software runs as a Windows application on a personal computer. It is recommended that the PC be dedicated to the console function to maximize PC response time and efficiency for the console function. However, other applications can also run simultaneously on the same PC. This enables both the console Attendant and the PC to multi-task between the call answering function and other PC applications.

The PC can toggle from Attendant Console mode to some other application, and back to the console mode. If a call is received while in another application, the PC can immediately switch back to the Attendant Console mode to handle the ringing call. This can be done either automatically with the Auto Activate option set to on or manually if it is set to off. Thus, when calling traffic is light, the Attendant can quickly and easily toggle back and forth between the Attendant Console mode and another application, automatically or at the touch of a button on the keyboard.

Benefits

Makes the PC a multi-purpose workstation during non-peak traffic periods. The Attendant uses time more efficiently between calls and maximizes the use of the computer.

Name or Number Dialing

System Availability

Optional on Strata DK424 with RCTUBA/BB, RCTUC/D, or RCTUE/F processors

Unavailable on Strata DK14/40i/DK424 with RCTUA processor

The Attendant can call anyone listed in the dial directory by typing their name (first, last, or both). This can be internal stations or external numbers. The dial directory searches the listing as characters are entered until a match is found. If several entries in the listing are similar, the use of the Up and Down arrow keys enable a call or transfer to a specific name.

Name dialing can also be used for finding departments as well as individuals. Many incoming calls are not for a specific person, but for a departmental feature or department. Callers requesting help by function may not know the name of an employee to ask for in the department they are requesting, i.e. "May I speak to someone in Customer Service." Dialing by function or department enables the Attendant to display a list of employee names and directory numbers, sorted by their function or department, and select the person or group (ACD or Distributed Hunt) that can best handle the call.

Benefits

Facilitates efficiency because the Attendant has internal and external numbers listed in a directory screen, or can use the name/number lookup and speed dialing. It's as easy as pressing a button or clicking the mouse. Time waste and errors can be easily avoided.

Overflow

System Availability

Optional on Strata DK424 with RCTUBA/BB, RCTUC/D, or RCTUE/F processors

Unavailable on Strata DK14/40i/DK424 with RCTUA processor

Overflow mode re-routes calls, which have been waiting in the ringing queue too long, to another console, station, or answering device as assigned in programming. This feature is controlled by the overflow timer and can be manually activated by the Attendant during high-traffic conditions via the Overflow button.

Benefits

Provides backup for the Attendant during busy periods when it is difficult to keep up with heavy incoming call traffic. Overflow serves as another efficient way of providing call coverage.

Override

System Availability

Optional on Strata DK424 with RCTUBA/BB, RCTUC/D, or RCTUE/F processors

Unavailable on Strata DK14/40i/DK424 with RCTUA processor

There are three ways to override calls:

- ◆ Busy Override lets the Attendant send a tone to a busy station to signal a call is waiting.
- ◆ Do Not Disturb (DND) Override lets the Attendant send a tone to an idle station in the DND mode to indicate that an important call is coming in.
- ◆ Executive Override lets the Attendant enter an established conversation.

Each of these can be enabled or disabled by programming.

Benefits

Enables the Attendant to access stations for emergency messages or high-priority calls.

Park and Page

System Availability

Optional on Strata DK424 with RCTUBA/BB, RCTUC/D, or RCTUE/F processors

Unavailable on Strata DK14/40i/DK424 with RCTUA processor

The Attendant can combine the Park and Page functions into one quick and easy function. The Park and Page feature enables the Attendant to park a call in one of the Park Orbits, enter a Page Zone or Group access code if desired, and announce the page. The console can be connected to a predesignated External Paging circuit, a Telephone Page group, or both. See Call Park in the Station Features chapter of this manual for more details on this feature.

Benefits

Provides quick and easy access to station paging by combining two functions into one. This saves the Attendant valuable time in high-traffic applications.

Position Busy

System Availability

Optional on Strata DK424 with RCTUBA/BB, RCTUC/D, or RCTUE/F processors

Unavailable on Strata DK14/40i/DK424 with RCTUA processor

The Position Busy feature makes it easy to place the console in unattended mode or re-enter the normal call processing mode. When in Position Busy mode, calls to the Attendant Console are routed to other attendants on the system.

This feature is intended for use only when more than one Attendant Console shares the load of incoming calls. In this mode, new calls are sent to other consoles. Held and unanswered transferred calls continue to recall to the console that processed them. When the last console in the Attendant group is placed in Position Busy mode, the entire group is considered unattended, and consoles must set Call Forward and/or Night Transfer to cause Attendant Console calls to be re-routed to another destination.

Benefits

Makes it easy for Attendants to leave for breaks at the touch or click of one button. In addition to procedural efficiency, call coverage provides smooth continuation of call answering by other consoles. Returning to service is just as easy, by pressing or clicking the Position Busy button.

Release Button

System Availability

Optional on Strata DK424 with RCTUBA/BB, RCTUC/D, or RCTUE/F processors

Unavailable on Strata DK14/40i/DK424 with RCTUA processor

The Attendant can click or press the Release button to release the console from any connection by disconnecting or transferring the call and placing the console in the idle state.

Benefits

Increases speed and efficiency by enabling the console Attendant to complete the call transfer and go idle with the click or press of one button.

Reminder Notes

System Availability

Optional on Strata DK424 with RCTUBA/BB, RCTUC/D, or RCTUE/F processors

Unavailable on Strata DK14/40i/DK424 with RCTUA processor

The Attendant has the option of entering a reminder note for an incoming call that is about to be transferred or placed on hold. The note is typically the name of the calling and/or called party. This note is displayed on hold calls in the Loop Hold display area, and in the message window whenever the call recalls to the console.

The reminder note is typically used to remind the Attendant who is holding or who they are holding for if the Attendant has to handle the call a second time. This secondary handling usually results from a transferred call recalling to the Attendant, or if the call has been on hold waiting for a page pickup and recalls to the Attendant. This makes it quick and easy to offer alternative call processing without having to start over with the caller.

Benefits

Enables a more personalized response to the caller when they have been put on hold, parked, or transferred. The Attendant can be reminded of who is calling and from whom they are holding when the call recalls to the Attendant. This saves time for the Attendant, because they don't have to ask a second time for whom the call is. It also gives the caller better service.

Split/Switch Button

System Availability

Optional on Strata DK424 with RCTUBA/BB, RCTUC/D, or RCTUE/F processors

Unavailable on Strata DK14/40i/DK424 with RCTUA processor

The Attendant can alternate between source and destination parties on hold, by clicking or pressing the Split/Switch button, while keeping the two parties separate on the console. This can only be performed when the console is involved in a three-way conference with a source and destination party. The parties can either be connected on outside lines only, on directory number DN lines only, or on a combination of outside and internal lines. The Split/Switch button does not function on four-party conference calls.

Benefits

Makes it quick and easy for the Attendant to talk to either of the other two parties. This is especially useful when the Attendant alternates between parties.

Speed Dial Calling

System Availability

Optional on Strata DK424 with RCTUBA/BB, RCTUC/D, or RCTUE/F processors

Unavailable on Strata DK14/40i/DK424 with RCTUA processor

Through the use of an “active keyboard,” the Attendant can access speed dial names or speed dial location numbers when dialing or transferring a call. When the Attendant types in a speed dial name or location number, the speed dial information is displayed for quick access. Up to 40 personal numbers and 100 (800 with RCTUE/F) system numbers can be stored in the speed dial list.

The Attendant enters the names for the speed dial numbers on the console. Names entered from the console can be different from those entered in the system records, so the Attendant can customize the names list for easy use.

Benefits

Provides a more efficient method of making calls by using the name/number lookup and speed dialing. It’s as easy as pressing a button or clicking the mouse.

Three-way Calling

System Availability

Optional on Strata DK424 with RCTUBA/BB, RCTUC/D, or RCTUE/F processors

Unavailable on Strata DK14/40i/DK424 with RCTUA processor

Three-Way Calling lets the Attendant talk with the source and destination parties simultaneously. This requires a connection with a station user or outside caller and a party on Consultation Hold. After placing a party on Consultation Hold and connecting to another party, the Attendant is engaged in a three-way conversation. The console display indicates the connection to both the source and destination parties. The Attendant can disconnect from the conference, leaving the other parties connected, or can add another party to the conference.

Benefits

Provides the flexibility of connecting calls together in more ways than the typical conferencing. The console Attendant can ensure the two parties get together before dropping out of the conversation. This is often more appropriate than using transfer, because the Attendant can provide more personalized service.

Through Dialing

System Availability

Optional on Strata DK424 with RCTUBA/BB, RCTUC/D, or RCTUE/F processors

Unavailable on Strata DK14/40i/DK424 with RCTUA processor

Through Dialing enables an Attendant to provide a restricted station user with temporary outgoing call privileges. On a call-by-call basis, the Attendant can access otherwise denied trunks and then pass the dial tone to the station user. The station user can then complete the call dialing procedure. Through Dialing can be applied to callers using DISA and incoming Tie trunks, as well as to station users. To access a specific trunk group, the Attendant's Class of Service must permit such access.

Benefits

Enables toll-restricted station users temporary access to outside lines through the Attendant on a per-call basis. This maintains the integrity of toll restriction, while still extending outgoing calling privileges when necessary.

Transfer Direct to Voice Mail

System Availability

Optional on Strata DK424 with RCTUBA/BB, RCTUC/D, or RCTUE/F processors

Unavailable on Strata DK14/40i/DK424 with RCTUA processor

Transfer Direct to Voice Mail Box provides the Attendant Console Attendant a Transfer to Voice Mail (TVM) button, on screen and on keyboard, to transfer outside callers directly to a station user's voice mailbox, rather than to their station which would forward to voice mail if busy or not answered.

This direct transfer to voice mail box function is used when the Attendant looks at the BLF or knows the requested station user is either busy or not available. This feature works the same regardless of the status of the destination station (busy, DND, idle, forward). It provides a way to transfer calls to the desired mailbox without relying upon proper forwarding set at the station. This is also useful for internal calling directly to a station's mailbox when you know they are not going to answer, or for transferring calls to mailboxes that do not have stations on the Strata DK system. The Attendant can release the call immediately after a voice mail port answers.

Benefits

Provides better service to callers by transferring a call directly to a busy or absent station user's mailbox. They can leave a message sooner without having to listen to ringing while forwarding. This is also more efficient for the console Attendant who will not get transfer recalls from stations that do not answer and may not be forwarded to voice mail.

Using this feature to reach Audiotext messages of VM gives the Attendant an efficient way to handle routine information requests, such as directions to the business location.

Trunk Group Control

System Availability

Optional on Strata DK424 with RCTUBA/BB, RCTUC/D, or RCTUE/F processors

Unavailable on Strata DK14/40i/DK424 with RCTUA processor

Trunk Group Control enables the Attendant to restrict access to outgoing CO line groups on an as-needed basis. This feature also lets the Attendant restrict outgoing calls on two-way CO line groups.

The display shows the group number of all trunk groups in which all lines within that group are currently in use. Trunk groups with no members are always shown busy.

These capabilities enable control of outgoing traffic on heavily used line groups during busy hours.

Benefits

Provides maximum availability for incoming calls and better service to callers because the trunk groups are as free as possible during peak traffic periods.

Volume Control

System Availability

Optional on Strata DK424 with RCTUBA/BB, RCTUC/D, or RCTUE/F processors

Unavailable on Strata DK14/40i/DK424 with RCTUA processor

The Volume Control buttons on screen adjust the Attendant Console's ringing volume and handset/headset volume. The ringing volume and the handset/headset volume are adjusted separately. The Volume Up button increases the volume, while the Volume Down button decreases the volume.

Benefits

Provides volume adjustments according to the Attendant's needs.

Strata DK424 Automatic Call Distribution (ACD) capability is provided as a value-added option with the RCTUBA/BB, RCTUC/D, and RCTUE/F processor versions. Each DK424 processor supports the following number of stations and CO lines.

- ♦ RCTUBA/BB – combination of up to 80 stations or 48 CO lines (up to 2 cabinets).
- ♦ RCTUC/D – combination of up to 240 stations or 144 CO lines (up to 6 cabinets).
- ♦ RCTUE/F – combination of up to 336 stations or 200 CO lines (up to 7 cabinets).

Note ACD is not available with the DK424 RCTUA or DK40i and DK14 systems.

ACD Operation

The ACD feature can accommodate up to 16 ACD groups, 120 individual Agent stations, 256 Agent identification codes, and 16 Supervisor identification codes (see [Table 15](#)).

Table 15 Strata DK System ACD Capacities

ACD Maximum Capacities for Strata DK424 Systems	RCTUBA/BB	RCTUC/D RCTUE/F
Number of Groups	8	16
Number of Supervisor Positions	8	16
Number of Agent ID Codes	200	256

Note See the *Strata DK General Description* for more information on common control units.

Call centers need an efficient method for the automatic distribution of a large number of incoming calls to prearranged groups of Agent positions. ACD in the Strata DK is the most cost-effective method for distributing incoming calls to call centers. The calls are served in the order of their arrival and are evenly distributed among the Agents (see [Figure 14](#)).

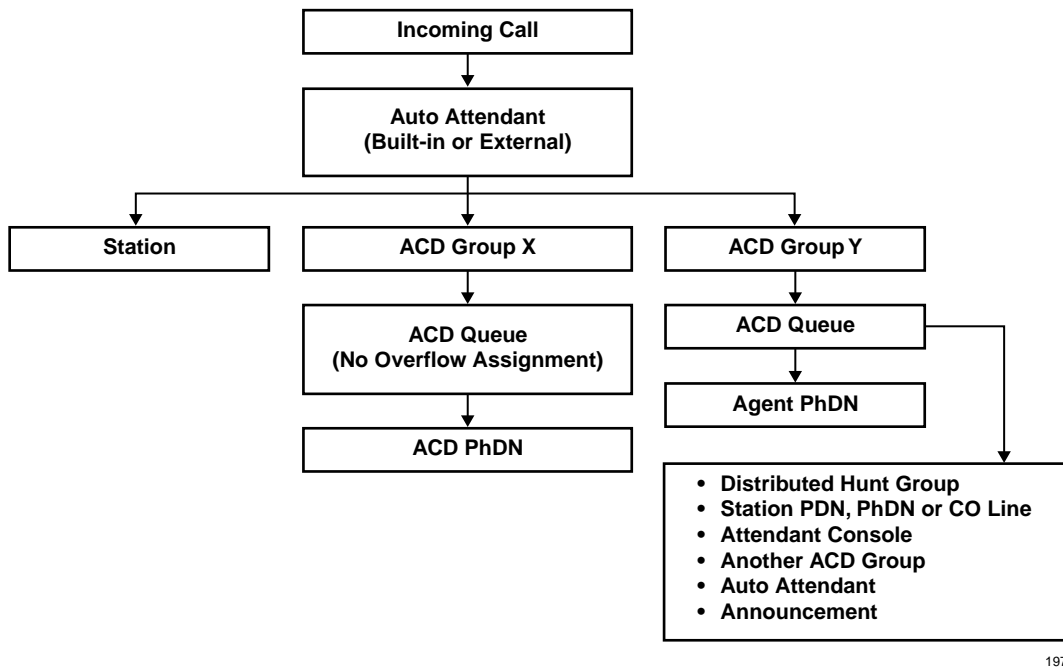

Figure 14 ACD and Auto Attendant Application Flow Diagram

ACD call centers can be telemarketing, inside sales, customer service, technical support, or any other group that handles a large number of incoming calls (see Figure 15).

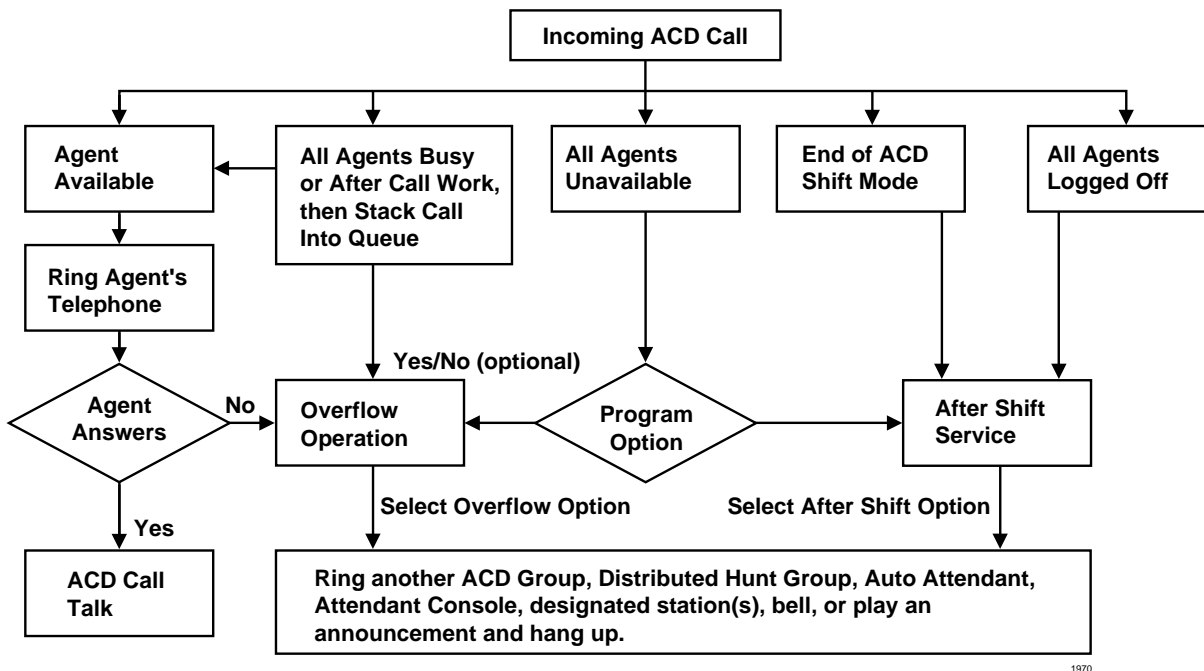

Figure 15 Typical ACD Interaction

ACD can distribute calls to all Agents in the group on a “Most Idle Agent Next”, so that over a given period of time, each Agent spends approximately the same amount of work time on ACD calls. Alternatively, ACD can distribute calls on a “First Available Agent Next” (rotation) basis, so over a given period of time, each Agent receives an equal number of ACD calls.

Callers waiting in queue can hear up to three different announcements per ACD group. A flexible sequence is provided to play these announcements for incoming calls when no Agent is currently available to handle the call. Between announcements, callers can hear music and/or company promotional/advertising messages provided by external equipment.

Additionally, calls that have been in queue for a predetermined time can be forwarded to another ACD group or other selected destination for immediate service.

Calls received after a group’s shift has ended (After Shift mode) are routed to an alternate answer point, such as another telephone’s DN, an Attendant, an Auto Attendant, a voice mail box, another ACD group or a Distributed Hunt (DH) group for call handling. In the After Shift mode, a different announcement can be used.

The DK424 transmits data about the operation of the ACD system to the Management Information System (MIS) processor, where it can be stored on hard disk. This data is manipulated by the MIS processor and organized into real-time displays and reports, and historical reports. The displays are provided to the ACD group supervisor via the MIS processor display screen. The reports can be called up by shift, hourly, daily, weekly, monthly, or annual periods. They can be either displayed at the supervisor terminal or printed on a printer connected to the MIS processor.

Toshiba offers two types of MIS products that are ideal for use with DK424 ACD applications.

- ♦ Call Center Viewer provides real-time ACD status displays and connection of electronic wall boards.
- ♦ Software MIS (SMIS) provides real-time displays and historical reports.

The Call Center Viewer application organizes and displays ACD call center events received from the DK424 system. The data is displayed on your PC screen in easy to read full color format.

- ♦ Real-time supervisor displays provide information on call queue status, agent status, and other useful information for managing the ACD groups.
- ♦ Audible alarms alert you when thresholds you assign are exceeded for the number of calls waiting, longest call waiting, and unavailable agents.
- ♦ Electronic wall boards can be connected to the supervisor’s PC to display call center data overhead from the Call Center Viewer application.

SMIS provides historical reports in a full featured and cost effective MIS package.

- ♦ Reports provide information and statistics on individual agents, ACD groups, or the system status.
- ♦ Reports can be generated over a selectable period of time for periods of minutes, shift, daily, weekly, monthly, and annually.
- ♦ Real-time supervisor displays provide agent statistics, agent status, call statistics, and system status.

The combination of Call Center Viewer and SMIS enables you to add ACD supervisory display and reporting capabilities as you need them. The Call Center Viewer application can work in conjunction with SMIS to provide the ideal solution for call centers needing historical reports, real-time displays, and electronic wall board messaging of call center ACD activity.

- ♦ The Call Center Viewer application can be used by itself in ACD applications needing PC screen ACD group status visibility but not MIS reports.
- ♦ Electronic wall boards can be connected to the PC running the Call Center Viewer application to provide over head message visibility.
- ♦ Additional Call Center Viewer applications can be added to support multiple ACD group and multiple ACD call center supervisor display applications.
- ♦ Software MIS (SMIS) can be used with Call Center Viewer for call centers needing historical reports as well as real-time displays for ACD group status visibility.

ACD agents may use either Toshiba-proprietary digital telephones or standard 2500-set telephones. The ACD supervisors will typically use digital LCD telephones. The use of digital telephones permits the end-user to assign agent features to flexible feature buttons for easier, more efficient operation. Use of LCD telephones is highly recommended, because it enables both supervisors and agents to use valuable display information such as the number of calls waiting in the group's queue and the length of time spent on each ACD call.

When applying the ACD function with the general use of the DK424, it is important to note that additional instruments are not needed for ACD agents. They can use that same telephone to make and receive regular system calls as well as receive calls into the ACD group. Outgoing calling privileges can be controlled by class of service and toll restriction.

Agent digital/electronic telephones require a unique, single appearing, PhDN button called the agent ACD Call button. Any single appearing PhDN can be used to log in to any ACD Group to receive ACD calls and to originate or receive PBX calls. Agents can also receive or make non-ACD calls from other DN buttons or CO line buttons.

ACD agents using digital/electronic telephones can answer and make various types of calls that are:

- ♦ ACD Call – An incoming external line call that is routed or transferred to an ACD Group and then rings an agent ACD Call button.
- ♦ PBX Call – An external or internal call that is routed or transferred directly to an ACD Call button directory number, and not routed through the ACD group. A PBX call is also a call originated from the ACD Call button on an agent telephone. When on a PBX call, an agent cannot receive ACD calls. When on an ACD call, an agent cannot receive PBX calls, but can originate and receive calls on CO or DN buttons other while on a ACD or PBX call is on hold.
- ♦ Non-ACD Call – Any call received by or originated from a directory number button or CO line button that appears on an agent telephone, other than the agent ACD Call button. When on a non-ACD call, an agent can receive ACD calls because the ACD calls will ring on the idle ACD Call button.

Any type of CO line that is used with the DK424 is also compatible with the ACD function. Ground start, DID, or Tie lines are preferred, due to their superior disconnect supervision capability. If loop start is used, reliable Automatic Release from the CO must be provided.

The maximum ACD agents allowed within each system processor with and without MIS are outlined in [Tables 16~19](#).

Table 16 Maximum Number of ACD Agents Allowed without MIS (RCTUBA/BB)

Light Traffic 15 calls per agent per hour		Medium Traffic 30 calls per agent per hour		Heavy Traffic 60 calls per agent per hour	
Agent Telephones	Non-agent Telephones	Agent Telephones	Non-agent Telephones	Agent Telephones	Non-agent Telephones
80	0	80	0	70	0
70	10	70	10	65	15
60	20	60	20	60	20
50	30	50	30	55	25
40	40	40	40	50	30
30	50	30	50	40	40
20	60	20	60	30	50
15	65	15	65	20	60
10	70	10	70	15	65
5	75	5	75	10	70
—	—	—	—	5	75

Table 17 Maximum Number of ACD Agents Allowed with MIS (RCTUBA/BB)

Light Traffic 15 calls per agent per hour		Medium Traffic 30 calls per agent per hour		Heavy Traffic 60 calls per agent per hour	
Agent Telephones	Non-agent Telephones	Agent Telephones	Non-agent Telephones	Agent Telephones	Non-agent Telephones
65	15	38	42	19	61
60	20	30	50	15	65
40	40	20	60	10	70
20	60	10	70	5	75
5	75	5	75	—	—

Table 18 Maximum Number of ACD Agents Allowed without MIS (RCTUC/D)(RCTUE/F)

Light Traffic 15 calls per agent per hour		Medium Traffic 30 calls per agent per hour		Heavy Traffic 60 calls per agent per hour	
Agent Telephones	Non-agent Telephones	Agent Telephones	Non-agent Telephones	Agent Telephones	Non-agent Telephones
120	120	120	24	70	0
108	132	118	30	65	30
80	160	108	60	60	60
60	180	98	90	55	90
40	200	88	120	50	110
30	210	78	150	45	140
20	220	68	172	40	170
15	225	60	180	35	200
10	230	50	190	30	210
5	235	40	200	25	215
—	—	30	210	20	220
—	—	20	220	15	225
—	—	10	230	10	230

Table 18 Maximum Number of ACD Agents Allowed without MIS (RCTUC/D)(RCTUE/F) (continued)

Light Traffic 15 calls per agent per hour		Medium Traffic 30 calls per agent per hour		Heavy Traffic 60 calls per agent per hour	
—	—	5	235	5	235

Table 19 Maximum Number of ACD Agents Allowed with MIS (RCTUC/D)(RCTUE/F)

Light Traffic 15 calls per agent per hour		Medium Traffic 30 calls per agent per hour		Heavy Traffic 60 calls per agent per hour	
Agent Telephones	Non-agent Telephones	Agent Telephones	Non-agent Telephones	Agent Telephones	Non-agent Telephones
65	175	38	202	19	221
60	180	30	210	15	225
40	200	20	220	10	230
20	220	10	230	5	235
5	235	5	235	—	—

Notes

- For the purpose of these tables, Agent calls are defined as ACD incoming, PBX incoming and outgoing, and external/internal calls. If an ACD call is transferred, then two calls are created, one ACD and one PBX.
- The maximum number of Agents shown in these tables is limited by the amount of MIS data traffic sent from Strata DK. If there are more than 1,000 Agent calls in a heavy-traffic hour, the MIS channel must be set higher than 1200 bps. The next higher speed, 2400 bps, can handle up to 1300 calls per hour. Strata DK allows the choice of 1200, 2400, 4800, or 9600 bps for the MIS channel. Based on a total system speed of 10,800 bps (9600 + 1200) for auxiliary serial channels and a requirement of one channel each for SMDI, TTY, SMDR, and MIS, the installation should use the lowest MIS channel speed for the expected amount of traffic.

Benefits

ACD gives the user a powerful tool for evenly distributing large volumes of inbound calls. It makes processing those calls easier and more efficient, saving money and increasing the productivity of the call handling Agents. This also improves the service provided to the outside caller.

ACD reports enable the Supervisors to monitor the performance of ACD groups and individual Agents within each group. This information makes it possible to configure the operation of the ACD system for maximum productivity and profitability. For more information about the reports, see [“ACD Supervisor Log In/Log Out”](#).

A Work Unit code can be 1~15 digits. SMDR registers 1~15 digits, but SMIS only registers 1 or 2 digits.

ACD System Features

An ACD group is usually composed of a number of agents handling similar types of incoming calls. Each ACD group is identified by an ACD group number.

Agents in each ACD group are identified by agent ID numbers. Agents log into the system by entering their ID from any telephone. This means agents are not tied to particular telephone sets, providing the flexibility to serve most any applicaiton. Incoming ACD calls for the agent's group are then routed to that station, when available or next in line to receive calls.

The following features are available in the ACD environment. A full description begins on [Page 270](#).

- ♦ “After Shift Service”
- ♦ “Automatic Disconnect”
- ♦ “Automatic Number Identification (ANI)”
- ♦ “Call Distribution”
- ♦ “Caller ID”
- ♦ “Delay Announcements and Music”
- ♦ “Dialed Number Identification Service (DNIS)”
- ♦ “Inbound Call Routing”
- ♦ “Overflow”
- ♦ “PBX Calls”
- ♦ “Queuing”
- ♦ “Queue Alarm Timer”

After Shift Service

System Availability

Standard on Strata DK424 with ACD except those with RCTUA processors

When an ACD group is in the After Shift mode, callers calling the ACD group are routed to the group's designated After Shift destination. Each group can have the same or different After Shift destinations. The After Shift destinations can be any of the following:

- ♦ A designated station or group of stations
- ♦ Another ACD group
- ♦ An announcement
- ♦ An Auto Attendant
- ♦ An Attendant Console
- ♦ A signaling device, such as chimes or a bell

If the After Shift destination is a telephone or announcement device, and it is busy, calls camp onto the destination. They are answered as the destination becomes available. If the After Shift destination is another ACD group, the call rings an Agent in that group. If all the Agents are busy, the call is sent to the end of that group's queue.

After Shift Service can be initiated two ways:

- ♦ The ACD Supervisor can press the End of ACD Shift button.
- ♦ The ACD group is automatically placed into the After Shift mode after all Agents logout or (as a program option) when all Agents are in the Unavailable mode. Calls that are in an ACD group queue just prior to the After Shift mode follow the normal queue routing programmed for that ACD group. The After Shift mode is automatically cancelled when the first Agent logs into an ACD group making the group available to receive ACD calls.

Benefits

Routes after-hours calls quickly and efficiently without effecting customer service. The destination can be another ACD group, telephone, or announcement device.

Automatic Disconnect

System Availability

Standard on Strata DK424 with ACD except those with RCTUA processors

Loop start CO lines do not reliably and automatically release when a caller hangs up. With the Automatic Disconnect feature, the user has the option to automatically disconnect calls which have been waiting in queue for a certain length of time. Automatic Disconnect can be set at 1 to 60 minutes after the call comes into the system or it can be disabled.

An example of Automatic Disconnect is when an incoming call is sent to an ACD queue, either music or an announcement is played for the caller. The call waits in the queue until an Agent answers it. If the caller hangs up while in the queue (abandoned call) or an Agent does not answer the call within the programmed Automatic Disconnect time, the call is automatically disconnected.

Benefits

Enables the efficient handling of expensive incoming calls, such as inbound 800 WATS line calls, because they do not wait endlessly. They are answered or disconnected after they have exceeded the waiting period.

Automatic Number Identification (ANI)

System Availability

Standard on Strata DK424 with ACD except those with RCTUA processors

The telephone number of a calling party is displayed on the LCD of a ringing Agent telephone and sent to a Personal Computer (PC). The system supports ANI on analog, digital (T1) DID, and Tie lines and provides useful call information to Agents.

ANI is usually associated with “1-800” type calls offered by various long distance carriers (except AT&T) through T1 facilities. However, the DK424 also provides ANI information received over analog DID and Tie line circuits.

ANI digits can be received independently or simultaneously with Dialed Number Identification Service (DNIS) called number digits. When received with DNIS digits, calls can be routed to unique ACD groups for each DNIS number. ANI data for answered calls can be displayed on SMDR reports.

ANI numbers that are abandoned before being answered, are stored in system memory so users know the calling party’s telephone number even if no message was left. Designated Agent or Supervisor LCD telephones can display and Auto Dial the abandoned call ANI numbers.

The system can store up to 2,000 ANI abandoned call numbers with the RCTUE/F processor, up to 1,000 with RCTUC/D, and up to 400 with RCTU-BA/BB. Individual stations can be programmed to store from 0 to 100 of the total ANI abandoned call numbers in increments of 10. DKAdmin can print a list of Abandoned Call numbers for all telephones that store lost call ANI numbers.

For computer applications, ANI and DNIS digits can be sent to an individual PC connected via an Integrated PC Interface Unit (RPCI-DI). This enables users to receive pop-up screens on their PC that provide information regarding the calling/called party before answering and during the call.

Benefits

Provides valuable information to agents as they answer calls. Computer applications enable users to receive pop-up screens on their PC, before answering and during the call, further enhancing service to callers. Abandoned call information provides the valuable ability to return calls to those callers who did not get through or did not leave a message.

Call Distribution

System Availability

Standard on Strata DK424 with ACD except those with RCTUA processors

Incoming ACD calls are automatically distributed in a uniform manner among available Agents in the group. The system offers two different methods for call distribution on a system-wide basis for all ACD groups in the system.

- ♦ Most-Idle-First – The first of these is true-ACD time-based routing. This algorithm attempts over a period of time to keep Agents in the group on ACD calls for approximately the same length of time.
- ♦ Next-Available First – The second algorithm, which is call-based, attempts to deliver an equal number of calls to the Agents in the group over a given time period.

Most-Idle-First routing is appropriate for most call distribution applications, since it tends to maximize the productivity of individual Agents and the overall efficiency of the entire group. However, some applications may need the specific capabilities of Next-Available-First routing. The end user can choose the call distribution method that best fits their application. In both cases, if all Agents are busy and calls are waiting in queue, the first Agent to become available will receive the call.

Benefits

Routes calls efficiently and effectively using the Agents in various groups and maximizes productivity. The overall efficiency of the entire Agent group is enhanced as well.

Caller ID

System Availability

Standard on Strata DK424 with ACD except those with RCTUA processors

The telephone number and name of a calling party is displayed on the LCD of a ringing Agent telephone and can be sent to a PC. A maximum of 10 telephone number digits and 15 name characters can be displayed or sent to a computer.

The Caller ID Interface (RCIU) PCB is required, in conjunction with the normal ground or loop start CO line PCBs to provide the Caller ID feature. It can be provided on analog loop start lines (RCOU/RCOS, PCOU) and analog ground start lines (RGLU) only. It is not available on any other type of analog lines, such as DID (RDDU), Tie (REMU, PEMU), or digital T1 lines (RDTU).

An RCIU/RCIS circuit must be available for each line that is to receive Caller ID. When ordered from the factory, the RCIU PCB comes equipped with four Caller ID circuits. An RCIS piggy-back PCB can be installed onto the RCIU to provide four more Caller ID circuits, for a maximum of eight Caller ID circuits per slot. Caller ID data for answered calls can be displayed on SMDR reports.

Caller ID data is stored in system memory for calls that are abandoned before being answered, so users know the name (if provided by the local CO) and telephone number of who called even if they did not leave a message. Designated Agent or Supervisor LCD telephones can display and Auto Dial the abandoned call numbers. The system can store numbers up to 2,000 with the RCTUE/F processor, 1,000 with the RCTUC/D processor, and 400 with the RCTUBA/BB processor. Individual stations can store from 0 to 100 in increments of 10.

DKAdmin can print a list of abandoned call numbers for all telephones that store abandoned call numbers.

For computer applications, Caller ID digits and names (if supplied by the local CO), can be sent to a PC connected via an RPCI-DI. This enables users to receive pop-up screens on their PC that provide information regarding the calling/called party before answering and during the call.

Benefits

Provides valuable information to agents as they answer calls. Computer applications enable users to receive pop-up screens on their PC, before answering and during the call, further enhancing service to callers. Abandoned call information provides the valuable ability to return calls to those callers who did not get through or did not leave a message.

Data Collection and Reporting

System Availability

Standard on Strata DK424 with ACD except those with RCTUA processors

The system collects real-time data and transfers it in packets to the MIS processor. The MIS processor organizes the information into real-time displays, statistics, and reports. The information collected includes ACD call activities (before and after answer), PBX call activity, Agent status, average wait times, lost calls, and ACD queue activities. Data can be displayed or printed. For more information, see [“ACD Call Center Viewer”](#) and [“ACD Software MIS \(SMIS\)”](#) later in this section.

Benefits

Effectively assists in managing call center operations.

Delay Announcements and Music

System Availability

Standard on Strata DK424 with ACD except those with RCTUA processors

Announcements and music are provided to calls in the queue at predetermined time intervals. The system provides flexible announcement patterns which can be assigned to each ACD group. Up to three different announcements can be programmed per group.

Each announcement can be recorded into an external customer-provided digital announcer. The message is synchronized to begin when a call is connected to the announcer.

Each ACD group can have its own announcements and/or music source, or groups can share the sources.

The lengths of the music intervals are selected when the feature is programmed.

Benefits

Provides valuable information to callers while they are on hold. It also keeps them occupied so they will continue to hold.

Dialed Number Identification Service (DNIS)

System Availability

Standard on Strata DK424 with ACD except those with RCTUA processors

DNIS identifies the number dialed by the calling party regardless of which incoming line the call is on. A 16-character alphanumeric is displayed on the ringing Agent telephone's LCD. DNIS digits can also be sent to an application computer. DNIS names will display on direct, incoming, and transferred calls that overflow from the ACD group that cannot forward calls to the ACD group. This enables calls to be answered appropriately by type of call.

DNIS is supported on digital (T1), or analog (DID), and Tie lines. It is typically used with 1-800 calls using long-distance carriers over T1, but can be provided over analog DID and Tie line circuits. DNIS calls can be routed to unique ACD groups for each DNIS number, and each DNIS number can be routed to different destinations during Day/Day2/Night mode.

DNIS digits can be received independently or simultaneously with ANI digits.

The Strata DK424 supports the following DNIS maximums (see [Table 20](#)).

Table 20 Strata DK424 Maximums

	RCTUBA/BB	RCTUC/3	RCTUE/F
DNIS Numbers	350	500	500
Telephone Network Numbers	200	300	300

Benefits

Enables multiple calls to the same line or line group, providing optimum trunk usage as well as helpful called number/name identification information. This provides more efficient usage of CO lines than the traditional usage of 800 numbers. Traditionally, each 800 number was assigned to its own line group, often resulting in a large number of under-used lines. The DK424's DNIS capability solves this problem by using each DNIS line on an as-needed basis for different 800 number calls.

Inbound Call Routing

System Availability
Standard on Strata DK424 with ACD except those with RCTUA processors

Calls can be routed into the ACD queues from incoming CO lines, DID, or Tie lines. They can be transferred into the ACD queue from the Auto Attendant, answer position, or any station in the system, as well as through the DNIS routing table. See the Strata DK424 ACD/MIS General Description for more details.

Benefits

Routes calls to the appropriate ACD group from anywhere within the system.

Overflow

System Availability

Standard on Strata DK424 with ACD except those with RCTUA processors

ACD calls are sent to the ACD group queue when all Agents in the group are busy. Calls in queue can be programmed to overflow to specified destinations or remain in queue and not overflow independently for each ACD group.

ACD calls in queue can be programmed to overflow to:

- ◆ A designated DN (PDN or PhDN) or group of stations
- ◆ Another ACD group
- ◆ An announcement
- ◆ An Attendant Console
- ◆ A signaling device such as chimes or a bell
- ◆ The DK424 built-in or external automated Attendant (ground/loop start lines only, not Tie, DID or DNIS lines)
- ◆ Voice mail
- ◆ Distributed Hunt group

An ACD group can have two overflow destinations programmed. The call overflows from the queue to one destination when the caller has received a specified number of announcements, with a maximum of three announcements. Calls are sent to the second destination when the caller has been in queue for a specified time up to a one hour maximum.

Overflow timing for each destination can be set independently so that overflow will occur at the first destination, if idle; but, if the first destination is busy, the call overflows to the second destination immediately or after a predetermined time delay.

Notes

- Tie and DID lines cannot be routed (overflow or otherwise) to the DK424 built-in Auto Attendant.
- Tie and DID lines can overflow to a single PDN, PhDN, or ACD group, but not to multiple stations.

Overflow-Idle Only

If an overflow destination is idle when a call's overflow time occurs, the call is immediately sent to the overflow destination. The destination can be a station or another ACD group. If both of these overflow destinations are busy, the call remains in the queue until either of these two overflow destinations become idle or an Agent in the original ACD group becomes idle.

The system continuously monitors the Agents and the overflow destinations for an idle condition and routes the call appropriately when one becomes idle.

- ◆ **Overflow to Another ACD Group:** An Overflow to Another ACD group sends the calls waiting in queue to another ACD group. Each ACD group can have an overflow group to act as a backup in the event that the original ACD group is unable to handle the call. Each ACD group can be the overflow point for multiple ACD groups. Each ACD group queue is associated with an overflow threshold which determines when the calls will overflow. Overflow can be set to occur after a user-specified time in queue and/or a particular point in queue. After the third “All Agents are Busy” announcement, for example.

If the overflow group’s Agents are all busy, the call will not overflow; it will remain in the original group’s queue.
- ◆ **Look-ahead Operation:** If the Overflow-idle Only option is set at overflow time, the system “looks ahead” to verify that the overflow destination is not busy. If it is busy, the call remains in queue and does not overflow. The system looks ahead, continuously checking the overflow destination, and sends the call to the overflow destination when it becomes idle.
- ◆ **Look-back Operation:** If the Overflow-idle Only option is set and the overflow destination is busy at overflow time, the system looks back continuously to check for an idle Agent in the ACD group while it simultaneously checks for an idle overflow destination. If either an overflow destination or an ACD Agent becomes idle, the system sends the call to that destination.

Overflow-Busy or Idle

The ACD call exits the queue and rings the overflow destination when it is idle or busy. The destination can be a station, a group of stations, an Attendant Console or the DK424 built-in Auto Attendant. If the overflow station is busy, it receives muted CO line ringing. If the DK424 Auto Attendant is busy, the overflowing call camps onto the Auto Attendant until it becomes idle at which time the Auto Attendant answers the call. Overflow to a busy destination is available on ground and loop start lines only – not on DID or Tie lines.

Benefits

Overflow provides callers better service when agents in the group are too busy to handle holding calls within a reasonable time frame. The various look-ahead and look-back options make sure that calls overflowing to another destination will be helped as soon as possible.

PBX Calls

System Availability

Standard on Strata DK424 with ACD except those with RCTUA processors

A PBX call is any incoming call (direct, transferred, forwarded, etc.) to the Agent's ACD Call DN button (not to the ACD group number). A PBX call is also any outgoing call placed from the Agent's ACD Call button. When on a PBX call, an Agent cannot receive ACD calls. When on an ACD call, an Agent cannot receive PBX calls.

Benefits

Enables making and receiving non-ACD calls in addition to ACD calls. PBX calls are reported on MIS reports in addition to ACD calls.

Queuing

System Availability

Standard on Strata DK424 with ACD except those with RCTUA processors

Each ACD group has its own queue. If Agents are busy as calls arrive at an ACD group, the calls are placed in queue. As the Agents become available, calls are distributed from the queue on a first-in, first-out basis. While in the queue, callers may listen to music, announcements, or be directed to an overflow destination.

Some of the key features of queuing are:

- ♦ The announcements and music source for each group can be separate or groups can share announcements and music sources.
- ♦ Queue timing parameters and announcement sequences can be set independently for each ACD group.
- ♦ Up to three different announcements can be sent to callers in an ACD queue. One, two, or three announcements can be repeated at intervals or the announcements can be sent only once. ACD announcements are sent to callers via dealer-supplied digital announcement devices, which must be connected to standard telephone circuit ports.
- ♦ Each group can have a separate music source or no music at all. The music source can be the system's Music-On-Hold source or a music source connected to a designated electronic or standard telephone port.
- ♦ The maximum time a call can be in an ACD queue can be set at one-second intervals for up to one hour for each ACD group. The time can also be disabled, allowing a call to remain in queue indefinitely. After the queue timer expires, the call will overflow to the queue's overflow destination if it is idle, or, depending upon the destination and programming, if it is idle or busy (refer to "Overflow" at the beginning of this section).
- ♦ The auto-disconnect time automatically disconnects a call in an ACD queue. This time is set or disabled separately for each ACD group and is normally only used on loop-start type central office lines which may not provide reliable disconnection if a caller hangs up while in an ACD queue.

Benefits

Provides flexibility so each ACD group can treat calls holding in queue according to the requirements of that group.

Queue Alarm Timer

System Availability

Standard on Strata DK424 with ACD except those with RCTUA processors

The Queue Alarm Timer may be programmed to sound immediately at the Supervisor's station when the number of calls in queue exceed a specified quantity or for a specified period of time (up to 255 seconds). A second alarm may be programmed to sound at any interval up to 600 seconds from the first call alarm.

The alarm alerts the Supervisor immediately when the queue size exceeds a predetermined threshold (1~144 calls), or permits up to two alarms to sound after a programmable wait time has passed. The queue thresholds are:

- ♦ First queue, program from 0~255 seconds
- ♦ Second queue, program from 0~600 seconds

Alarms can be used in a maximum of 16 ACD groups (8 on RCTUBA/BB).

Benefits

Alerts the Supervisor when corrective action is required. This provides better service to callers.

ACD Agent Features

An Agent in an ACD group may use either a Toshiba-proprietary telephone or standard type telephone. Toshiba-proprietary telephones have feature buttons and may have a LCD. The feature buttons can be used to access Agent features. The LCD provides information about each ACD call and the ACD group.

The following are the features available to an ACD Agent.

- ♦ “ACD, PBX, and Non-ACD Calls”
- ♦ “ACD Call Pickup”
- ♦ “ACD Display Information”
- ♦ “ACD Help”
- ♦ “After Call Work Time”
- ♦ “Auto Answer with Zip Tone”
- ♦ “Log In/Log Out”
- ♦ “Unavailable Mode”
- ♦ “Work Unit”

ACD, PBX, and Non-ACD Calls

System Availability

Standard on Strata DK424 with ACD except those with RCTUA processors

Agent digital/electronic telephones require a unique, single appearing PhDN programmed on an ACD Call button. Any single appearing PhDN can be used to log in to any ACD group to receive ACD calls and to originate or receive PBX calls. Agents can also receive or make non-ACD calls from other DN or CO Line buttons. ACD Agents can answer and make these various types of calls as defined below.

- ♦ ACD Call – An incoming external line call that is routed or transferred to an ACD group and then rings on the ACD Call button.
- ♦ PBX Call – An external or internal call that is routed or transferred directly to the ACD Call button and not routed through the ACD group. A PBX call is also a call originated from the ACD Call button on an Agent telephone. When on a PBX call, an Agent cannot receive ACD calls. When on an ACD call, an Agent cannot receive PBX calls.
- ♦ Non-ACD Call – Any call received by or originated from a DN or CO Line button that appears on an Agent telephone, other than the ACD Call button. When on a non-ACD call, an Agent can receive ACD calls, because the ACD calls will ring on the ACD Call button if idle.

Benefits

ACD agents can make and receive regular calls in addition to receiving ACD calls. PBX calls will be reported on MIS reports in addition to ACD calls.

ACD Call Pickup

System Availability
Standard on Strata DK424 with ACD except those with RCTUA processors

ACD Call Pickup enables ACD Agents or Supervisors to answer ACD calls ringing to Agents within their group by pressing the ACD Pickup button. Only calls to Agents logged into the same ACD group can be picked up.

Benefits

Agents can answer calls for each other when needed.

ACD Display Information

System Availability
Standard on Strata DK424 with ACD except those with RCTUA processors

This feature provides ACD Agents (using an LCD electronic/digital telephone) with a visual indication of ACD call progress information, in addition to the standard display operation. When an Agent position is in ACD mode, the number of ACD calls waiting in queue can be shown on the LCD. Caller ID, ANI, and DNIS can also be displayed for incoming calls.

Benefits

Agents have display information available to provide better service to callers.

ACD Help

System Availability

Standard on Strata DK424 with ACD except those with RCTUA processors

This feature enables an ACD Agent to call the Supervisor position for assistance. Pressing the ACD Help button, while in the talk state, automatically places the current ACD call on hold and initiates an assistance call to the Supervisor position. As soon as the Supervisor answers the call, the Agent may establish a three-way conversation or may talk privately with the Supervisor, and then return to the caller, or transfer the call to the Supervisor.

Benefits

ACD agents can quickly and easily get supervisor assistance when they need it.

After Call Work Time

System Availability

Standard on Strata DK424 with ACD except those with RCTUA processors

Also known as Wrap-up Time, After Call Work Time gives the Agent a predetermined amount of time to complete work (paperwork, order processing, filing) regarding the last ACD call. After disconnecting from an ACD call, the Agent automatically enters After Call Work Time mode until the predetermined “After-Call Work Time” period expires, or until the Agent manually exits this mode by pressing the End After Call Work button.

When in “After-Call Work Time,” an Agent does not receive more ACD calls from the system. The Agent can receive or place a non-ACD or PBX call during After Call Work Time, but the call automatically cancels After Call Work Time Status.

Benefits

Agents have time to complete required actions before taking the next call.

Auto Answer with Zip Tone

System Availability

Standard on Strata DK424 with ACD except those with RCTUA processors

Auto answer will automatically connect an available Agent to an incoming ACD call without requiring the Agent to lift the handset or push a button. When an ACD Agent position is in auto-answer mode (electronic/digital telephone feature), the system will provide an audible burst of tone (zip tone) to the Agent position before connecting the Agent to the incoming ACD call. The zip tone will sound to the headset, if used, or to the telephone speaker.

Benefits

This feature enables ACD agents to answer calls faster.

Log In/Log Out

System Availability

Standard on Strata DK424 with ACD except those with RCTUA processors

Enables the Agent or Supervisor to log IN or OFF the ACD system by dialing an Agent or Supervisor identification (ID) code from any station. When an Agent logs into the system, the station is activated as an ACD Agent position and is available for incoming ACD calls. Operating statistics are collected for the Agent and output to an optional MIS processor until the Agent logs out (when the station leaves ACD mode).

If an Agent attempts to log OUT and if the Agent is the last one logged into an ACD group, the flashing Log IN/OUT LED notifies the Agent that additional calls are waiting. In this case, the Agent will not be able to log OUT until the calls are answered and the ACD group queue is empty.

Agent digital and electronic telephones must have a unique, single-appearing PhDN that is designated as the ACD Call button. Standard telephones receive ACD calls on their PhDN after logging into an ACD group.

Benefits

Any ACD agent can log into any group from any telephone on the system. This provides flexibility and convenience.

Unavailable Mode

System Availability

Standard on Strata DK424 with ACD except those with RCTUA processors

This feature enables an Agent to become temporarily unavailable to ACD calls without having to log out. The Unavailable mode can be used for lunch and coffee breaks, extended work times, etc.

When Agent telephones are placed in the Unavailable mode by using a flexible feature button, dialing code, or when two successive ACD calls are sent to the Agent and are not answered (automatic).

All Agents Unavailable

If all Agents in a group are made unavailable at the same time, new calls to the group are directed to the normal overflow point destination or the end-of-ACD shift destination of the ACD group. This destination option is a system option, and it applies to all ACD groups. It can also be assigned independently.

If the end-of-ACD shift or “all Agents unavailable” overflow destination is a busy station or announcement device, the call camps onto the busy destination or routes to other designated telephone or announcement.

If the all-Agents-unavailable overflow destination is another ACD group, the call rings an Agent in that group. If all the Agents are busy in the overflow group, the call enters the overflow group’s queue. If the overflow group’s Agents are unavailable or the group is in the After Shift mode, the call follows the normal routing scheme programmed for the overflow ACD group.

ACD Calls Ring No Answer (RNA)

If a call is RNA to one Agent in the group, the call rings an idle Agent in the same group. The Ring Agent Timer program sets the time limit for answering a call. The time period can also be assigned independently for each ACD group.

If there isn’t another idle Agent telephone, the call is directed to the group’s normal overflow point destination. If the normal overflow point destination is busy when an RNA call is routed to it, the call is re-routed to ring or camp-on to other designated telephones or is sent to an announcement. All of these options are set in system programming.

Benefits

Agents can become temporarily unavailable for ACD calls without having to log out of the group, providing flexibility and convenience.

Work Unit

System Availability

Standard on Strata DK424 with ACD except those with RCTUA processors

The Work Unit button enables an Agent to use the dial pad to tag a current call for tracking purposes. Work Unit Identifiers may be used to track various data (response to sales campaigns, calls from a particular area, etc.). A Work Unit code can be 1~15 digits. SMDR registers 1~15 digits, but SMIS only registers 1 or 2 digits.

The information is output to the system SMDR for printout and to MIS for reports. The Work Unit feature only applies to ACD calls, not to PBX or non-ACD calls.

Note SMDR only registers the last Work Unit code entered for each call; SMIS registers multiple work unit codes for a given call (e.g., 01 for Cookware, 02 for Furniture, etc.).

Benefits

Work unit codes help keep track of the type of calls received.

ACD Supervisor Features

The ACD group Supervisor can access all the standard Strata ACD features using the ACD Supervisor's ID code. When the Supervisor is not logged into the ACD system, full access to all of the standard DK telephone features is available.

It is recommended that the Supervisor use a Toshiba-proprietary telephone to monitor the operation of an ACD group with 10- or 20-feature buttons. It is also recommended that the Supervisor use an LCD telephone, because it provides important information about the ACD system and group, such as Queue and Agent Status.

Unlike Agent telephones, Supervisor telephones do not require a single appearing PhDN to operate ACD Supervisor features. However, it is recommended that a Supervisor telephone be equipped with at least two PDNs to answer Agent assistance request calls if the Supervisor is busy on another call.

Each Supervisor can supervise only one group at a time.

The following ACD features are available only to the Supervisor position.

- ♦ “ACD Agent Assistance”
- ♦ “ACD Call Pickup”
- ♦ “ACD Supervisor LCD Display”
- ♦ “ACD Supervisor Log In/Log Out”
- ♦ “Call Monitoring”
- ♦ “End of ACD Shift”
- ♦ “MIS Access”
- ♦ “Queue Alarm Indication”

ACD Agent Assistance

System Availability

Standard on Strata DK424 with ACD except those with RCTUA processors

ACD Agent Assistance provides visual indication to the Supervisor position when an Agent assistance call takes place. When an Agent calls an idle Supervisor station by pressing the ACD Help button, the Supervisor station starts ringing and a message indicating the assistance call and the Agent ID is shown on the LCD. The Supervisor can connect directly to the Agent by pressing the flashing PhDN button.

The Agent can then speak privately with the Supervisor, or can initiate a three-way conference with the Supervisor and the ACD caller, or transfer the call to the Supervisor. When the Supervisor hangs up, during a conference call, the Agent remains connected to the ACD call. If the Agent hangs up, during a conference call, the Supervisor remains connected to the call.

Benefits

Provides quick and easy access to the supervisor.

ACD Call Pickup

System Availability
Standard on Strata DK424 with ACD except those with RCTUA processors

ACD Call Pickup enables a Supervisor to pick up an Agent's ACD call within an ACD group. The call is considered a non-ACD call by the MIS system.

Benefits

Enables answering calls by the Supervisor when agents are unable to answer.

ACD Supervisor LCD Display

System Availability

Standard on Strata DK424 with ACD except those with RCTUA processors

The ACD Supervisor's LCD telephone can display the number of calls holding in the queue of a particular ACD group. By pressing the Queue Status button, the LCD displays the number of calls in queue. The Supervisor can also scroll through individual calls holding in queue, displaying the line number and how long the call has been in queue. Any ACD Supervisor can display queue information about the ACD group logged into or other ACD groups in the system. The queue status display is updated every five seconds.

The ACD Supervisor's LCD telephone can display the status of Agents within a particular ACD group. By pressing the Agent Status button, the LCD shows how many ACD Agents are logged into the group. The Supervisor can also scroll through individual Agents logged in, displaying the Agent ID number, telephone station number, and Agent status (available, unavailable, ACD call, PBX call, or After Call Work Time). The Agent status display is updated every five seconds.

Benefits

Provides valuable status information to the Supervisor on their LCD with or without an MIS processor.

ACD Supervisor Log In/Log Out

System Availability
Standard on Strata DK424 with ACD except those with RCTUA processors

The ACD group Supervisor logs into the group by pressing the Log IN/OUT button, followed by the Supervisor ID code. This station now has access to Supervisor features, but the station will not receive ACD calls.

Benefits

Makes convenient and easy monitoring of group activities by the Supervisor.

Call Monitoring

System Availability

Standard on Strata DK424 with ACD except those with RCTUA processors

Call Monitoring enables a Supervisor to monitor a conversation between an ACD Agent and ACD caller. A one-way, listen-only path is established for the Supervisor while the Agent and the caller continue their conversation.

As a system-wide programming option, a periodic tone can be inserted into a conversation to indicate that the Supervisor is monitoring. The message is also displayed on the Agent telephone's LCD. Or, on a system-wide basis, the monitoring can be done without the tone being inserted into the conversation.

Once in the monitor state, the Supervisor continues to monitor each ACD call to the Agent and does not have to re-initiate the monitor function with each ACD call. Only ACD calls can be monitored, not PBX calls or non-ACD calls.

Benefits

Provides additional call monitoring flexibility and is a valuable training tool.

End of ACD Shift

System Availability

Standard on Strata DK424 with ACD except those with RCTUA processors

The group Supervisor can use the End of ACD Shift button to activate the After Shift service of an ACD group shift.

If there are Agents logged in, the End of ACD Shift LED will flash until the last Agent logs off after all calls in queue have been answered. Then the LED will be steady on. All incoming calls to the ACD group after End of ACD Shift is engaged are directed to a preassigned After Shift destination.

Benefits

Enables routing of calls that occur after hours quickly and efficiently without affecting customer service. The destination can be another ACD group, telephone, or announcement device.

Insight DK and Insight DK Plus

System Availability

Optional on Strata DK424

The Insight DK system is a call center management software product that can be configured for businesses served by the Strata DK 424 Business Telephone System. The Insight DK and Insight DK Plus systems are full-featured ACD MIS tools for call center supervisors, providing user-defined supervisor displays, user-defined historical reports, scheduled reports, electronic wall board connection, and inView™ LAN-based status display messaging.

Insight DK and Insight DK Plus are a Microsoft® Windows®-based software programs capable of using on PCs running Windows 95, Windows 98 or Windows NT®.

- ♦ Insight DK is designed for simple supervisor applications. Insight DK offers 3 types of real time windows, 4 real time window templates, 12 varieties of reports which cover up to a year's worth of data; and it supports wallboards.
- ♦ Insight DK Plus supports up to 80 Supervisor Terminals. It provides more extensive display and reporting capabilities, including graphical information, forecasting, and data exporting. It also supports electronic wallboards.

Insight DK Plus provides 5 types of real time windows, and unlimited number of real time templates, 28 kinds of reports which cover up to a year's worth of data which can be exported to other report generator or spreadsheet programs.

Configurations

The configurations start with a single supervisory position. System option modules can be added, including:

- ♦ External, wall mounted electronic reader boards for displaying information to a group.
- ♦ inView LAN-based PC displays that provide information to Agents or Supervisory personnel. (See [“inView Features” on Page 315](#) for graphics of the displays).
- ♦ Fully capable sub-supervisors, that allow individual sub-supervisors to control the reports and displays needed for their group(s). Each sub-supervisor PC needs to be on with the Insight DK Plus application fully functioning while the monitored ACD groups are active to continually collect the real time data needed to display complete information for each shift. This is not required for reports generated by sub-supervisor PCs because reports are generated from information from the master PC.

The configurations can include database backup capabilities, including collecting data and acting as an additional resource for generating reports. For instance, critical databases can be stored on a reliable server, such as the server used for backing up the organization's information. Also, redundant MIS servers, connected to the Strata DK with a “Y” connector box, can collect event data, thus performing additional backup.

Single Supervisor Configurations

A single supervisor configuration can be implemented using either Insight DK or Insight DK Plus. The software is installed as a networked Server installation, but no physical network connection is required. All data is collected and reported from this single position. As with all Insight DK configurations, external electronic reader boards, such as a Spectrum Wallboard, can be added using an additional COM Port. For an example of a single supervisor configuration, see [Figure 15](#).

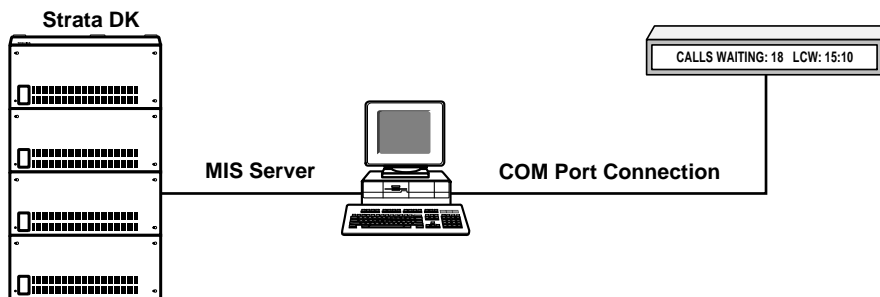

3908

Figure 16 Single Supervisor Configuration

Single Supervisor with inView LAN Displays

The single supervisor configuration can be upgraded to provide a Client/Server operation using the inView LAN Display clients. These displays can operate on a number of desktops connected via the in-house LAN. The Insight MIS Server requires a Network Interface Card (NIC) and must be connected to the LAN. The upgrade key for activating inView clients is sold in multiple concurrent users licenses to provide the desired number of users.

The Insight MIS Server controls a list of possible users which can be larger than the number of concurrent licenses. These clients can be started at any time and will reflect the current status and statistics maintained by the MIS Server. See [Figure 15](#) for an example of a single supervisor with inView displays.

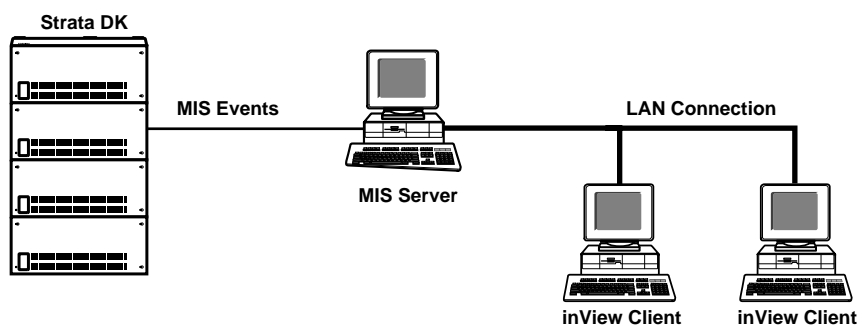

3909

Figure 17 Single Supervisor with inView Displays

Multiple Supervisors Configurations

Multiple supervisor configurations are supported using the Insight DK Plus version only. This configuration starts with one PC as the MIS server (the one connected to the Strata DK). All additional PC's loaded with the Insight DK Supervisor software are known as Sub-supervisors and receive the MIS Events using the LAN and messages relayed by the MIS Server. Each supervisor position provides complete control of its own data, how it is presented and how that location needs to operate with a particular group of Call Center Agents.

The sub-supervisors would typically rely upon the MIS Server for keeping an accurate database of events and use that database for all reports prepared by the sub-supervisor. Each Supervisor can collect and report on data stored at each location. In this configuration, the Sub-supervisor will be responsible for data relating to its real time display screens. See [Figure 15](#) for an example of a multiple supervisor configuration.

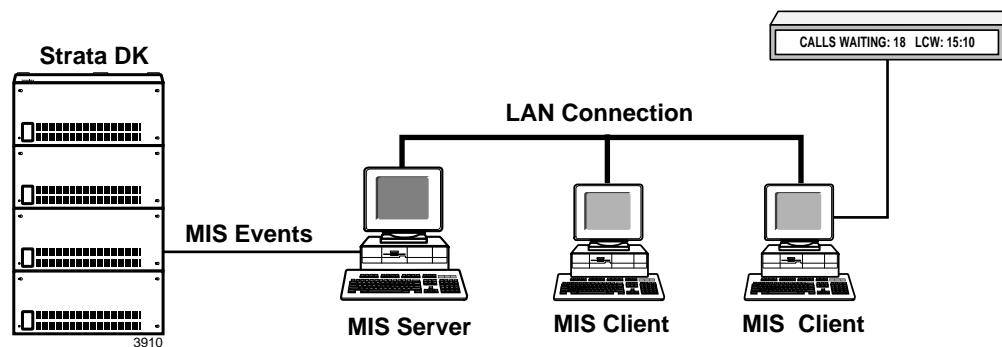

Figure 18 Multiple Supervisor Configuration

Multiple Supervisors with inView LAN Displays

The combinations of the previous configurations can be extended to include both MIS Supervisor Clients and inView Display Clients at the same time. This combination can provide the best of both applications where Call Center Supervisors need to control the reports and agents in that particular group while still providing key information to agents or other management personnel using inView Client. An example of multiple supervisors with inView LAN displays is shown in [Figure 15](#).

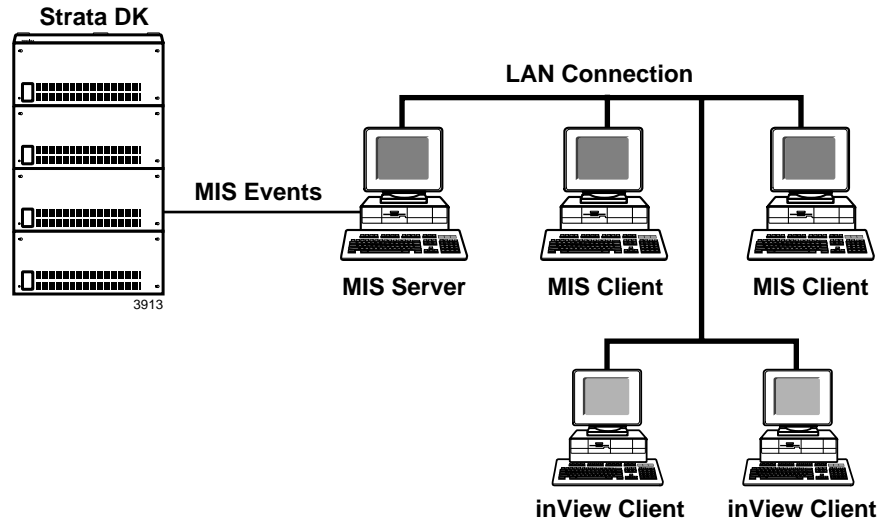

Figure 19 Multiple Supervisors with inView Displays

Database Backup Scenario #1

One of the common techniques for ensuring the reliability of the database in PC based systems is to provide redundancy of the hard drive memory within the Server. This can be accomplished by adding additional hardware within the MIS server and using either redundancy (mirroring) or striping of the hard drives for this redundancy.

In many cases, it may be too expensive to provide the redundancy within the MIS Server. To accommodate this using other components that may be already available within the customer site, the data files can be located on an existing Server which already is built with these capabilities. The MIS Server is responsible for the database and files, but routines and operations concerning backup and redundancy can administered by the administrator of the Network Server. An example of Database Scenario #1 is shown in Figure 15.

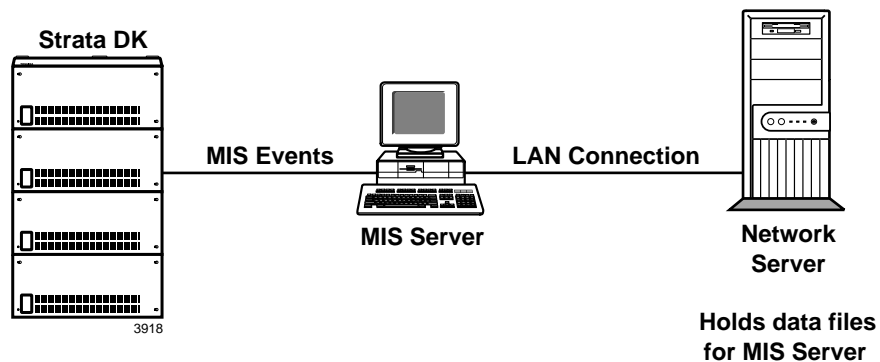

Figure 20 Database Backup Scenario #1

Database Backup Scenario #2

A second method of providing security to the databases could be providing redundant MIS Servers, each collecting information from the Strata DK. This operation is more costly in that two MIS Server Licenses will need to be purchased. It does carry the added capability that two different devices are collecting the Call Events and keeping a database of activities. The switching from the Primary to the Backup Server is not automatic, but requires manual changes from each client making the connection to the server. Database Backup Scenario #2 is depicted in [Figure 15](#).

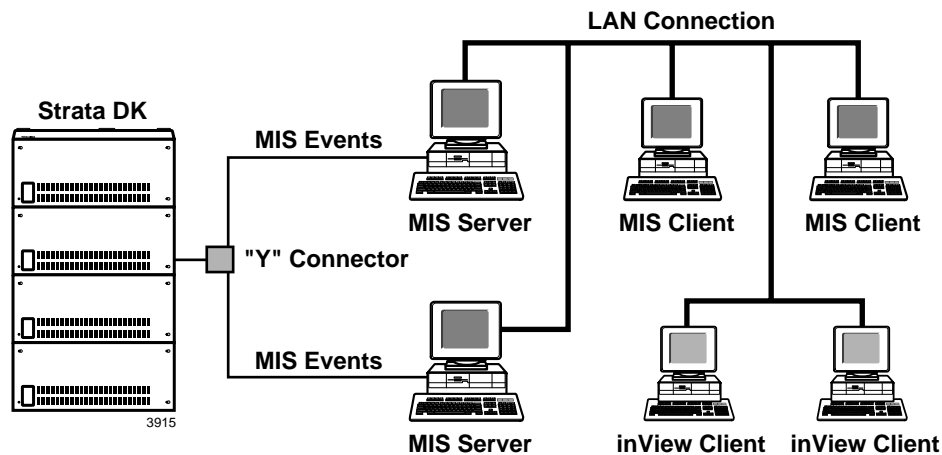

Figure 21 Database Backup Scenario #2

Fully Configured Insight DK Plus System

A fully configured Insight DK Plus system can contain up to 80 supervisors, and many inView Clients. Each supervisor can have external wallboards to display messages and information for that group of agents. The MIS Server could be implemented with dual MIS Servers for data redundancy or it could be connected to an in-house server which provides the database redundancy and backup routines as part of the normal operation of the in-house computer system. The choices are up to the needs of the customer. See [Figure 15](#) for an example of a fully configured system.

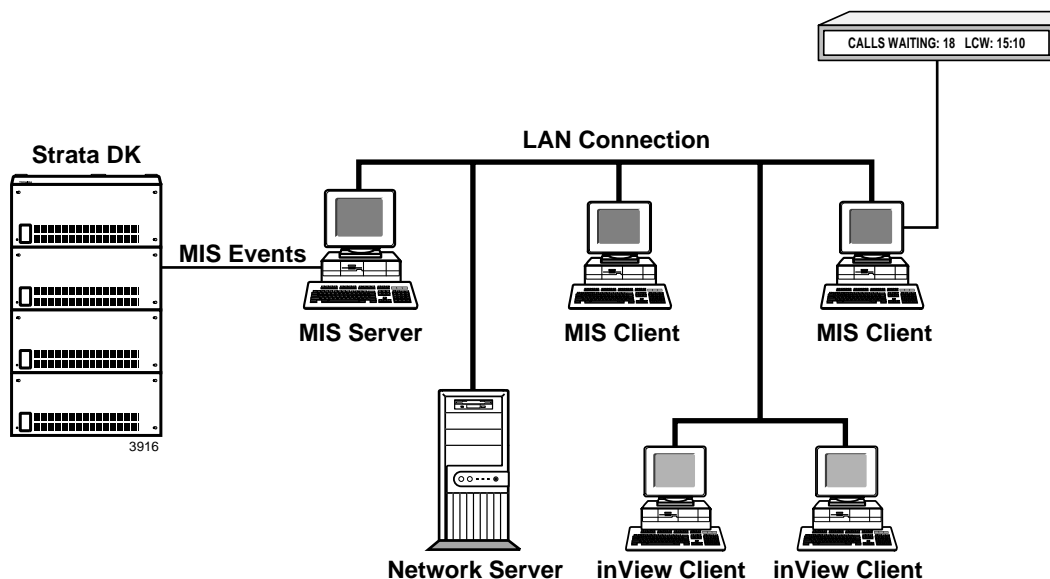

Figure 22 A Fully Configured System

Strata DK System Compatibility

The Insight DK product family is compatible with the Strata DK280 and DK424 Business Telephone Systems. The ACD functionality was introduced with Release 2 and has continued to be enhanced through the latest release. Due to differences in operation with the different releases, not all parameters will be reported in some Strata DK systems. A summary of differences follows:

- ♦ Release 2 uses CO Line positions for ACD calls and thus does not have the concept of PBX calls nor outgoing calls from an agent. DID numbers could not be used as part of ACD calls, thus DID reports will not report any data.
- ♦ Release 3 uses Phantom DN's for ACD calls and the introduction of PBX calls. Dialed Number Identification Services (DNIS) can be used to route calls to ACD groups, but reporting of this number over the MIS Link was inconsistent and the DID reports cannot be relied upon for accurate information unless the system uses Release 3.2 or higher.
- ♦ Release 4 adds messages for indicating when an agent phone is ringing. Reports of calls overflowing from an agent who does not respond to the ringing line and the call moves to another agent within the same group can be counted.

Toshiba recommends using Release 3.2 or higher with Insight DK to get the full value of the reported events.

Single Supervisor Configuration – Server

Hardware

- ♦ Pentium® PC - minimum 133 MHz
- ♦ 16 MB minimum memory for Windows 95/98 or 32 MB for Windows NT 4.0
- ♦ 1 printer port for license verification and optional printer connection
- ♦ 1 COM port for Strata DK MIS Event data stream

- ✦ 1 internal or external modem with minimum 14,400 bps speed
- ✦ Optional Network Interface Card (NIC) running TCP/IP and NetBEUI

Software

- ✦ Dedicated PC: Windows 95 (A, B or C version only) or Windows 98
- ✦ Shared PC: Windows NT 4.0 SP3
- ✦ Running additional programs can done with Windows NT Workstation if the customer is willing to risk data disruption if the PC must be restarted. Never run additional programs when using Windows 95/98.
- ✦ Symantec's pcAnywhere® is required for Technical Assistance from Toshiba

Multiple Supervisor Configuration – Server

Hardware

- ✦ Pentium PC - minimum 133 MHz
- ✦ 32 MB minimum memory
- ✦ 1 printer port for License Verification and optional printer connection
- ✦ 1 COM port for Strata DK MIS Event data stream
- ✦ 1 internal or external modem with minimum 14,400 bps speed
- ✦ Network Interface Card (NIC) running TCP/IP and NetBEUI

Software

- ✦ Windows NT 4.0 Workstation SP3 (up to 10 connections) or Windows NT Server 4.0 SP3 (greater than 10 connections)
- ✦ Do not run additional programs except as diagnostic tools on the MIS Server
- ✦ pcAnywhere is required for Technical Assistance from Toshiba

Insight DK MIS Client (Sub-supervisor)

Hardware

- ✦ Pentium PC - minimum 133 MHz
- ✦ 16 MB minimum memory for Windows 95/98 or 32 MB for Windows NT 4.0
- ✦ Network Interface Card running TCP/IP and NetBEUI

Software

- ✦ Dedicated PC: Windows 95 (A, B or C version only), Windows 98
- ✦ Shared PC: Windows NT 4.0 SP3
- ✦ Running additional programs can done with Windows NT Workstation if the customer is willing to risk data disruption if the PC must be restarted. Never run additional programs when using Windows 95/98.

- ◆ Each sub-supervisor PC needs to be on with the Insight DK Plus application fully functioning while the monitored ACD groups are active to continually collect the real time data needed to display complete information for each shift. This is not required for reports generated by sub-supervisor PCs because reports are generated from information from the master PC.

inView Client

Hardware

- ◆ Pentium® PC - minimum 133 MHz
- ◆ 16 MB minimum memory (Windows 95/98) and 32 MB (Windows NT 4.0)
- ◆ Network Interface Card running TCP/IP and NetBEUI

Software

- ◆ Dedicated PC: Windows 95 (A, B or C version only) or Windows 98
- ◆ Shared PC: Windows NT 4.0 SP3

System Functionality

The ACD MIS software is designed with a high degree of flexibility to suit the needs of a wide range of call centers. The sophistication of the product can be hidden until the call center manager is ready to take advantage of the enhanced capabilities of the MIS. To give even more flexibility, there are two variants of the ACD MIS software, with a simple upgrade path between them:

- ◆ The entry-level product is called “Insight DK.”
- ◆ The enhanced product is known as “Insight DK Plus.”

General Features

The following lists features which are provided by Insight and Insight DK Plus.

License Options

There are a number of options available with both products with respect to sizing, wallboards and sub-supervisor positions. These options are controlled by the software protection (license key) system and the user license.

Sizing

Both products may operate up to 256 agents, with 256 extensions and 200 lines. Up to 500 groups and 100 supergroups are supported. Both products allow up to 100 account codes.

Electronic Wallboards

Wallboards are supported by Insight DK and Insight DK Plus. Up to six wallboards may be connected to each supervisor position. Wallboard drivers supplied are compatible with the Shorekarn Messagemaker and a range of Spectrum Inc. wallboards, including:

- ◆ Shorekarn Messagemaker 2 x 16
- ◆ Spectrum 215C 1 x 15

- ♦ Spectrum 320C 1 x 20
- ♦ Spectrum 4120C 2 x 20

Sub-Supervisors

Subsequent supervisor positions are available with Insight DK Plus. The number of subsequent supervisor positions available is limited to 80 positions total.

Remote Access

Remote access is supported by Insight DK. To use this feature an additional remote access package, pcAnywhere, is required by the user and the Toshiba support service center.

Password Protection

Password protection of the configuration is standard.

Help File

There is a comprehensive context-sensitive help file with both products, which provides users with immediate on-line assistance on operation and programming.

Alarms

Alarms are available to enable the supervisor continue with their daily activities knowing they can rely on the MIS to tell them when there is a problem. Audible and visual alarms may be programmed at the individual device or group level.

Flexible Reporting

Reports can be compiled using statistics relating to any shift pattern, as defined by the call center manager. When compiling a report, the user defines the time period over which the report is compiled. This period can be defined to the nearest minute and is not limited to any time boundaries. For example, a report can be set to cover only information relating to the call center's night shift from the period of 11:04 p.m. on May 21, 1998 to 3:43 a.m. on June 3, 1998.

The resolution of event reports is to the second. For profile reports the user may set the resolution to any integral value of minutes, hours, days or weeks.

Automatic Reporting

The Automatic Reporting feature in Insight enables reports to be generated at user defined times. Different report templates can be set up to be generated at different time intervals and there is a choice of outputs, i.e., the reports could be sent to a printer, saved to disk, or exported.

Reporting Output Options

- ♦ Print – After a report is generated, it is automatically printed from the Insight DK default printer.
- ♦ Close on Completion – After a report is generated or any other output options selected have been completed, the report is removed from the Insight Reporter screen.
- ♦ Save to file – (Insight DK Plus only) The generated report is saved to the file name specified. Every time this report is generated the name is overwritten.
- ♦ Export to file – (Insight DK Plus only) Similar to “Save to file,” this option creates a text file that can be opened in another application, such as a spreadsheet package.
- ♦ Basic Scheduling – Basic allows you to select hourly, daily or weekly and allows you to choose the time that the selected reports get generated.
- ♦ Advanced Scheduling – Advanced options include more control over the frequency, starting date, starting time and control over the period of the report.

Retrospective Analysis

Reports can be compiled even after software upgrades (including upgrades from Insight DK to Insight DK Plus) using data collected from the original installation date of the MIS. If a new report type is added to Insight DK, it can be used to analyze all previously collected MIS data.

Insight DK Features

The entry level ACD MIS is known as Insight DK. In addition to the previously described general features Insight DK also has the following features:

- ♦ Three different types of real time windows are available
- ♦ Four real time templates can be created using any number of windows
- ♦ There are 12 types of reports available on the Insight DK
- ♦ Reports cover a maximum period of 1 year
- ♦ Wallboards are supported
- ♦ inView LAN-based displays are supported

Real Time Displays

The following real time windows are available:

- ♦ Forty different parameters can be shown using the Large Character windows
- ♦ Three different types of status displays:
 - ♦ Agent
 - ♦ Line
 - ♦ Extension
- ♦ Four different types of statistical displays:
 - ♦ Agent
 - ♦ DID

- ✦ Extension
- ✦ Line Group

These displays may be configured to report on individual devices, device groups or on a supergroup (groups of groups). The only limit to the number that can be displayed at any one time is the size of the screen and the size of each window. Four real time templates may be created and saved at any time. See Figure 15 for an example of Real Time Displays.

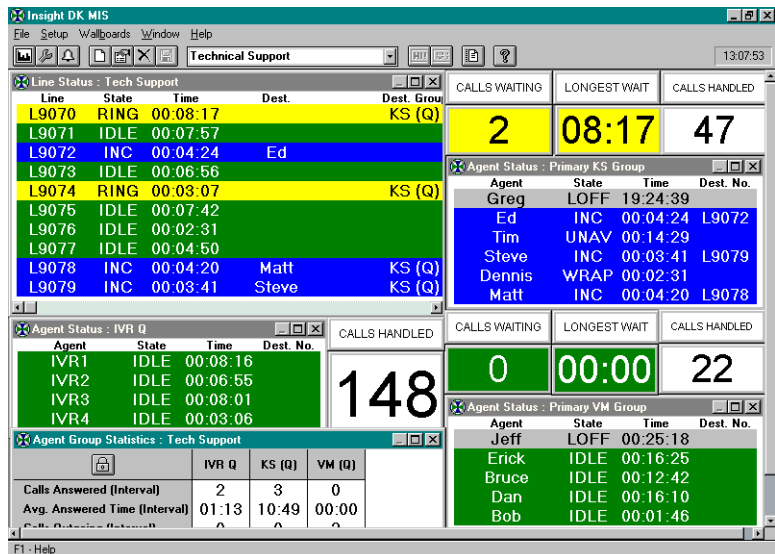

Figure 23 Sample Real Time Screen Using Insight DK Displays

Insight DK Plus

The enhanced ACD MIS product is the Insight DK Plus. As well as the general features described previously, Insight DK Plus provides the following:

- ✦ Five different types of real time windows
- ✦ Any number of real time templates
- ✦ 28 types of reports
- ✦ Up to one year's worth of data reports
- ✦ Ability to export reports in comma delimited format to spreadsheet packages like Excel or Lotus® 1-2-3®, where information can be displayed in graphical format.
- ✦ The Insight DK Plus database can be exported (in call record format) to Microsoft's Open Database Connectivity (ODBC) compliant database for further analysis.
- ✦ Supports wallboards
- ✦ Supports sub-supervisors
- ✦ Supports inView LAN-based displays

Insight DK Plus Real Time Displays

The following real time windows are available:

- ♦ Over 200 different parameters can be shown using the Large Character windows.
- ♦ Three different types of status displays:
 - ♦ Agent
 - ♦ Line
 - ♦ Extension
- ♦ Four different types of statistics displays:
 - ♦ Agent
 - ♦ DID
 - ♦ Extension
 - ♦ Line Group

There are also two different types of graphical displays:

- ♦ Wait Time
- ♦ Calls in Queue

These displays may be configured to report on individual devices, device groups or on a supergroup (groups of groups). The only limit to the number that can be shown at one time is the size of the screen and the size of each window. Four real time templates may be created and saved at any time. [Figure 15](#) shows sample Real Time Displays with graphs.

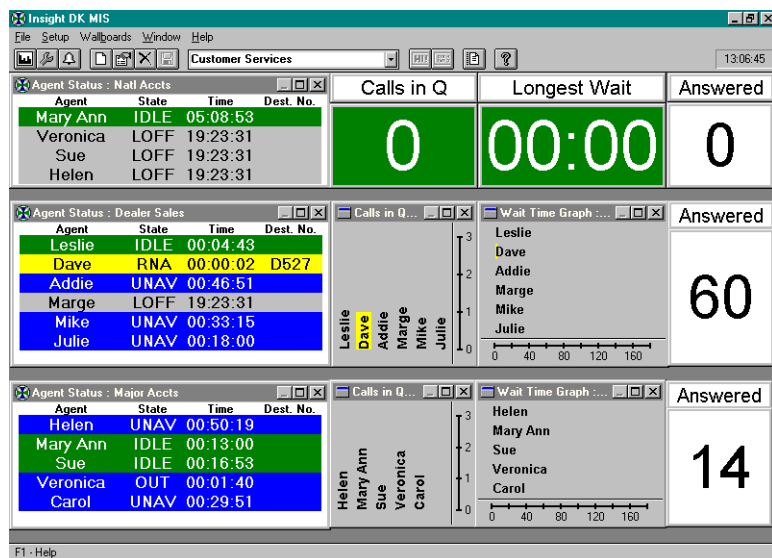

Figure 24 Sample Real Time Display including Graphs

In addition to being viewed on the screen and being printed, reports may be saved. Reports may be exported as text files and database call records may be exported to Microsoft Open Database Connectivity (ODBC) compliant databases with 16-bit drivers.

Reports

Reports can be viewed on screen and printed, but may not be saved. The maximum period of an individual report is one year. To view data over a period of two years, it is necessary to compile two consecutive reports (each of period one year). Reports may be compiled using data collected right back from when the product was first installed. [Figure 15](#) shows a sample Agent Report.

24 Hour		Demonstration								Page 1 of 3		
START:	Monday 11/26/98 14:30	All Reports on Insight DK+								on		
STOP:	Friday 11/30/98 15:30									11/09/98		
Agent Traffic for All Agents											Part 1 of 2	
Agent	Total			Answered Calls				RNA		Outgoing		
	Calls	Ave. Time	% Use	Calls	Ave. Call	Ave. Talk	Ave. Wrap	Calls	Avg. Wait	Calls	Avg. Calls	Avg. Talk
Andrew Parker	1	01:26:25	1.2	0	00:00	00:00	00:00	0	00:00	1	01:26:25	01:26:25
Dave Stringer	95	14:57	19.7	84	16:80	13:49	02:29	0	00:00	11	04:38	04:38
Dale Whitaker	96	09:47	13.0	81	11:18	08:32	02:46	0	00:00	15	01:37	01:37
Beverly Cardner	101	12:12	17.1	98	12:24	09:36	02:48	1	06:57	2	04:55	04:55
Phil Otell	0	00:00	0.0	0	00:00	00:00	00:00	0	00:00	0	00:00	00:00
Jane Yeasky	79	16:49	18.5	70	16:45	14:31	02:14	0	00:00	9	17:20	17:20
Jenny Harrington	0	00:00	0.0	0	00:00	00:00	00:00	0	00:00	0	00:00	00:00
Alan Harrson	65	15:01	13.6	58	16:33	14:27	02:06	0	00:00	7	02:13	02:13
Gareth Wear	72	13:23	13.4	63	14:27	11:43	02:44	1	06:39	8	05:50	05:50
Tracy Oldman	67	18:02	6716.8	60	19:58	17:30	02:28	0	00:00	7	01:25	01:25
Alson Halton	76	16:28	17.4	51	16:24	14:08	02:16	0	00:00	25	16:35	16:35
Total	652	14:25	11.9	565	15:11	12:40	02:31	2	06:48	85	09:35	09:35

3465

Figure 25 Sample Agent Report

Types of Reports

This section defines the types of reports available for the user. The terms used in the reports are explained in the next section. Insight DK Plus offers all of the reports listed. Insight DK provides a subset of these reports, shown in **bold** in [Table 21](#).

Table 21 Insight DK and DK Plus Reports

Report Type	Available for	Shows	Uses
Event Reports	<ul style="list-style-type: none"> ◆ Agents ◆ Extensions ◆ Line Groups 	Each event shown per line with important information.	Provides a step-by-step account of what is occurring on a particular device.
Traffic Reports	<ul style="list-style-type: none"> ◆ Agents ◆ Extensions ◆ Lines 	Each device is shown per line with call statistics presented in columnar format.	Traffic Reports are designed to give an overview of activity and performance of all members of a group.

Table 21 Insight DK and DK Plus Reports (continued)

Report Type	Available for	Shows	Uses
Group Traffic Reports	<ul style="list-style-type: none"> ◆ Agent Groups ◆ DID Groups ◆ Ext. Groups ◆ Line Groups 	Each line reports call statistics and performance. Each group of the super group are displayed in a side-by-side columnar format.	Group Traffic Reports are designed to give an overview and comparison of activity and performance against certain parameters.
Traffic Profile Reports	<ul style="list-style-type: none"> ◆ Agents ◆ Extensions 	Each line reports a time period with call statistics for a particular device reported in a columnar format.	Shows activity of particular device for selected performance parameters.
Group Traffic Profile Reports	<ul style="list-style-type: none"> ◆ Agent Groups ◆ DID Groups ◆ Ext. Groups ◆ Line Groups 	Each line reports call statistics for a particular group reported over a profile time period.	Shows peak and quiet times for a particular group.
Utilization Reports	<ul style="list-style-type: none"> ◆ Agents ◆ Extensions 	Each line reports a particular device with statistics displayed as the percentage of time involved in a given activity in a columnar format.	Utilization Reports can be used to see how the resources in a particular group are being used.
Utilization Profile Report	<ul style="list-style-type: none"> ◆ Agents ◆ Extensions 	Each line reports a time period with statistics displayed as a percentage of time in a given activity in a columnar format.	Utilization Profile reports show the peaks and valleys of a selected device over the selected time periods.
Contention Reports	<ul style="list-style-type: none"> ◆ Agents ◆ Extensions ◆ Lines 	Each line shows a number of idle devices and each group in a columnar format.	Contention Reports are used to show the amount of time (%) a line or agent is free over the reporting period.
Contention Profile Reports	<ul style="list-style-type: none"> ◆ Agents ◆ Extensions ◆ Lines 	Each line shows a number of idle devices and time profiles in a columnar format.	Contention Profiles provide a view when devices are busiest over the period defined.
Wait Time Distribution Reports	<ul style="list-style-type: none"> ◆ DIDs ◆ DID Groups ◆ Lines 	Each line reports a time period for the groups shown in a columnar format.	Wait Time Distribution Reports are used to profile the times into a chart.
Wrap-up Time Distribution Reports	<ul style="list-style-type: none"> ◆ Agents ◆ Agent Groups 	Each line reports a time period for the groups shown in a columnar format.	Wait Time Distribution Reports are used to profile the times into a chart.
Call Time Distribution Reports	<ul style="list-style-type: none"> ◆ Agents ◆ DIDs ◆ Extensions ◆ Lines ◆ Agent Groups ◆ DID Groups ◆ Ext. Groups ◆ Line Groups 	Each line reports a time period for the groups shown in a columnar format.	Wait Time Distribution Reports are used to profile the times into a chart.
Account Code Reports	<ul style="list-style-type: none"> ◆ Acct Code Groups 	Each line reports the statistics for an account code number.	Account Code Reports present information relating to the purpose of the call as defined by the user.

Table 21 Insight DK and DK Plus Reports (continued)

Report Type	Available for	Shows	Uses
Forecast Reports	<ul style="list-style-type: none"> ◆ Standard ◆ Profile 	Each report shows the original data for the period and modified data.	The report can be either a profile or standard report.

24 Hour START: Wednesday 10/28/98 00:00 STOP: Wednesday 10/28/98 23:59	TSD Irvine Technical Support	Page 4 of 15 on 11/02/98
--	--	--------------------------------

Agent Group Traffic for Tech Support			Part 1 of 1
Agent Group	IVR Q	KS (Q)	VM (Q)
Calls answered	79	75	57
Calls intercom	0	0	0
Calls outgoing	0	11	7
Average answered call time	01:02	13:31	15:30
Average wrapup time	00:01	02:29	02:27
Average intercom call time	00:00	00:00	00:00
Average outgoing call time	00:00	10:09	08:07
Longest answered call time	01:49	49:22	01:05:01
Longest wrapup time	00:03	03:16	03:15
Longest intercom call time	00:00	00:00	00:00
Longest outgoing call time	00:00	56:05	21:27
Minimum agents logged on	0	0	0
Maximum agents logged on	2	4	4
Number of short calls	0	0	0
Number of long calls	0	0	0
G.O.S.(%)	100.0	100.0	100.0

4058

Figure 26 Sample Agent Group Statistics Report

inView Features

Examples of the two different types of views are shown below:

- ◆ Wallboard View which displays statistics in a large character format (see Figure 15).

CIQ	LWT	Ans	Abd	Ans	GOS
0	0	205	7	25	100.0

Ready NUM

Figure 27 inView LAN Wallboard

- ◆ Status view shows the status of individual agents with either long or short names (see Figure 28). The status is presented using a colored background to represent each agent's status.

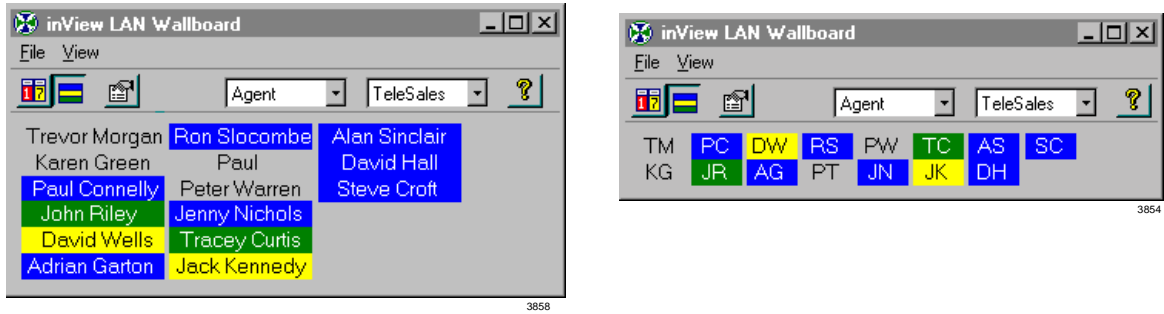

Figure 28 Sample inView Agent Status Display (Long Names and Short Names)

MIS Access

System Availability

Standard on Strata DK424 with ACD except those with RCTUA processors

If the Call Center Viewer or SMIS option is installed, the ACD group Supervisor can access the MIS displays and reports using the MIS processor connected to the DK424 system. The Supervisor can call up displays and reports on the groups or individual Agents to monitor ongoing performance.

The Supervisor can also signal the system to print out reports using a printer connected to the MIS processor. The MIS processor provides Supervisors with a wide variety of status, statistics, and traffic displays used to monitor the performance of ACD groups and individual Agents.

Benefits

Provides important management tools to the ACD Group Supervisor. For more information, see the Call Center Viewer and Software MIS (SMIS) later in this section.

Queue Alarm Indication

System Availability

Standard on Strata DK424 with ACD except those with RCTUA processors

An alarm is generated at the Supervisor's station when calls waiting in the queue exceed predetermined conditions. These conditions or queue thresholds (e.g., number of calls waiting, waiting time for the oldest call) are established in system programming independently for each ACD group. The audible alarm will continue at the station until the Supervisor acknowledges the alarm by pressing the Reset Queue Alarm button.

Benefits

Provides an alert to the ACD Group Supervisor when corrective action is required. This helps provide better service to callers.

ACD Feature Interaction

Strata DK424 provides the ACD features from system-resident software. Some station feature operations are altered when a station is activated as an ACD Agent or Supervisor station. Most all normal features are available to Supervisor and Agent telephone PDNs and PhDNs, except for the PhDN designated as the ACD Call button on an Agent telephone when it is logged into an ACD group.

The following features are described completely in the following pages.

- ♦ “Assistance From Busy Supervisor”
- ♦ “Call Forwarding”
- ♦ “Executive/Busy Override”
- ♦ “Message and Display”
- ♦ “Station Do Not Disturb (DND)”

Assistance From Busy Supervisor

System Availability

Standard on Strata DK424 with ACD (some station feature operations are altered when activated as an Agent or Supervisor station)

If a Supervisor telephone is busy and has an idle PhDN button (up to four PhDN buttons are available) and the Busy Station Transfer/Busy Station Ring feature option is enabled on the Agent/Supervisor telephones, an Agent can still ring the Supervisor telephone for assistance.

Benefits

Provides the Agent a means to get the Supervisor's attention for assistance, even when all the DN's on the Supervisor's telephone are in use.

Call Forwarding

System Availability

Standard on Strata DK424 with ACD (some station feature operations are altered when activated as an Agent or Supervisor station)

ACD Agent and Supervisor Primary and non-ACD PhDNs can set Call Forwarding. This applies for all types of Call Forwarding enabled on PDNs and PhDNs. If an Agent telephone ACD Call PhDN button is forwarded, ACD calls will not forward, but other types of calls (PBX and non-ACD) will forward in the normal manner.

If a Supervisor telephone PhDN is Call Forwarded, Agent assistance calls will not forward but will ring the Supervisor's PhDN; other types of calls to the PhDN will forward normally.

Benefits

Provides flexibility of handling call forwarding differently for non-ACD calls, which should forward, and ACD calls which should get overflow handling.

Executive/Busy Override

System Availability

Standard on Strata DK424 with ACD (some station feature operations are altered when activated as an Agent or Supervisor station)

If an Agent is talking on an ACD or PBX call, override is not enabled. However, the Agent can be called by dialing the Agent's PDN or an idle PhDN.

Benefits

Provides override only the ACD Group Supervisor and keeps ACD Agents from being disturbed except when the Supervisor deems it necessary.

Message and Display

System Availability

Standard on Strata DK424 with ACD (some station feature operations are altered when activated as an Agent or Supervisor station)

When an Agent or Supervisor ID is entered, the LCD shows ACD-related messages. While the telephone is in the ACD state, Soft Key labels and standard LCD messages, unrelated to ACD, do not display.

Caller ID, ANI, or DNIS information displays on an Agent telephone and overwrites Calls In Queue information when an Agent receives a Caller ID, ANI, or DNIS call. The Agent can retrieve the Calls In Queue display by pressing the LCD Page button.

Benefits

Provides the ACD-specific display information that ACD Agents and Supervisors require for optimum efficiency.

Station Do Not Disturb (DND)

System Availability
Standard on Strata DK424 with ACD (some station feature operations are altered when activated as an Agent or Supervisor station)

The Station DND feature is not applicable to ACD calls and only applies to non-ACD calls.

Benefits

Enables calls to ACD Agents to flow as normal and the DND feature to apply only to non-ACD calls.

ACD Call Center Viewer

System Availability

Standard on Strata DK424 with ACD software and MIS port

The Toshiba Call Center Viewer application organizes and displays ACD events reported by the Strata DK424 MIS port. The data displays on a host PC screen in easy-to-read, full-color Microsoft® Windows® format. The Call Center Supervisor gets real-time information on call queue status, Agent status, and other useful information for managing the ACD groups.

The Call Center Viewer application runs concurrently with other Windows applications on the ACD Supervisor PC. This enables ACD Supervisors to manage their ACD groups while working in other applications. Multiple Call Center Viewer applications can be used simultaneously on a DK424 system to accommodate multiple ACD Supervisors.

The data can also display on optional Spectrum Electronic Wall Boards that can be purchased from the Spectrum Corporation.

Call Center Viewer can be used on the same DK424 system in conjunction with the Toshiba Software MIS (SMIS), when historical reporting is required. Call Center Viewer provides the multiple displays and connection of electronic wall boards, while SMIS provides the historical ACD reports.

Computer Requirements

The Call Center Viewer application does not require a dedicated PC. When The Call Center Viewer application connects to the DK424, it functions as a machine-to-machine interface, constantly updating call center data. Toshiba recommends installing the Call Center Viewer application on a customer-supplied PC that meets the following recommended minimum requirements.

- ♦ IBM-compatible Pentium® 100 MHz PC
- ♦ Windows 95
- ♦ 16MB RAM
- ♦ 10MB available hard drive space for the application
- ♦ 3.5 1.44 MB floppy-disk drive
- ♦ 1 available serial communication ports (2 if using wall boards)
- ♦ Parallel printer port (for activation key)
- ♦ VGA color monitor
- ♦ Keyboard and mouse
- ♦ Windows Graphics Accelerator

Increasing the processor speed and adding more RAM improves the host PC's and the Call Center Viewer's performance.

Display Information

The Call Center Viewer displays the following information:

- ◆ Number of Agents
 - ◆ Logged in
 - ◆ Busy
 - ◆ Available
 - ◆ Unavailable
- ◆ Number of calls in the queue
- ◆ Longest call waiting
- ◆ Individual Agent status and status times (available on the host PC screen, but not on the wall board)
- ◆ Strata DK date/time
- ◆ User-defined messages to the wall boards

Main View

The Main View (shown below) displays the names and status of all active ACD groups. Columns can be sorted in ascending or descending order.

Name	Calls Wa...	LCW	Logged i...	Avail Agts	Unavail ...	Busy Agts
Tech Suppo	2	0:05:55	35	0	15	0
Sales Suppc	1	0:01:25	2	0	1	0
Market Supp	2	0:02:05	3	0	0	0
Internal Supp	5	0:14:23	3	0	1	0
Customer Su	0	0:00:00	2	1	0	0
Customer Su	1	0:03:40	2	0	1	0
Customer Su	0	0:00:00	2	0	0	0

Figure 29 ACD Main View

Agent View

The Agent View (see [Figure 30](#)) displays the status of all Agents in a group. It also displays real-time ACD Agent status information across the top of the Agent listings (see “[Button View Format](#)” on [Page 328](#) for a list of displayed information).

The window can be enlarged to fit more Agents. However, the number of Agents displayed on the screen depends in part upon monitor size and resolution. Agent names can be customized to be longer than the eight-character length provided by the Strata DK.



Figure 30 ACD Agent View

Alarms

Visual and audible alarms alert the call center Supervisor when certain thresholds are exceeded. The Supervisor can then take appropriate action. Visual alarms flash the screen or title bar. Audible alarms sound over the standard PC speaker or play a sound wave (.WAV) file through the PC's sound card and speakers. Alarm thresholds (see Figure 31) are user defined to enable flexible control of service levels.

Visual and audible alarms for each ACD group include:

- ♦ Calls in queue (number of calls waiting)
- ♦ Longest call waiting
- ♦ Unavailable Agents

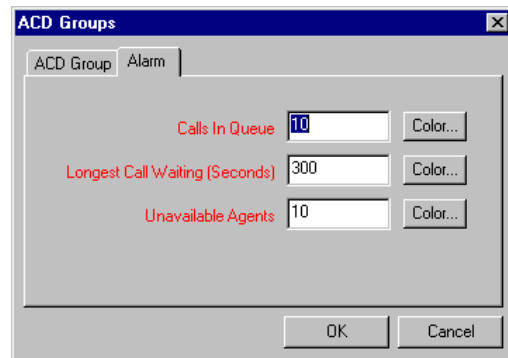

Figure 31 ACD AlarmThresholds

Title Bar

The title bar (see Figure 32) makes it easy to constantly monitor the ACD group's status while working in other applications. It fits conveniently into the unused area of most applications, at the top or bottom of the screen. It displays real-time ACD status information that is visible to the Supervisor at all times, and provides visual and audible alarms to alert the Supervisor when thresholds are exceeded.

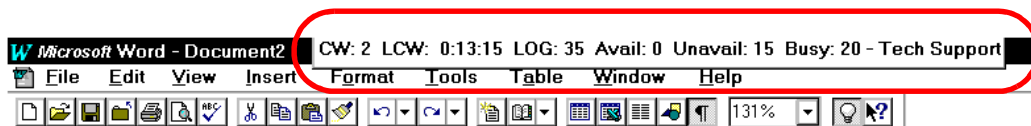

Figure 32 Title Bar Display

The title bar displays the following information:

- ◆ Number of calls waiting (CW)
- ◆ Longest call waiting (LCW)
- ◆ Number of Agents logged-in (LOG)
- ◆ Number of busy Agents (Busy)
- ◆ Number of Agents available (Avail)
- ◆ Number of Agents unavailable (Unavail)
- ◆ Group name (“Tech Support”)

Button View Format

The title bar can also be displayed in a condensed Button View format (see [Figure 33](#)). Button view displays as one of the open applications minimized on the Windows task bar line at the bottom of the screen. Clicking the mouse on the button expands the Button View to the full line display.

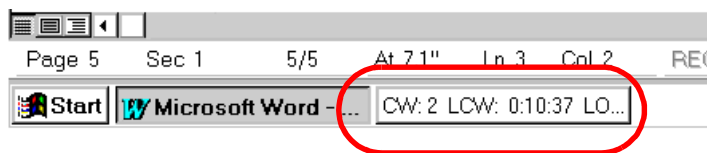

Figure 33 Button View

Configurations

The Call Center Viewer computer can connect directly to the DK424, to other Call Center Viewer computers, or to a Software MIS (SMIS) computer.

Direct Connection to DK424

The Call Center Viewer application host PC can connect directly to the DK424 MIS port on an RSIU, RSSU, PIOUS, or PIOUS card (see [Figure 34](#)).

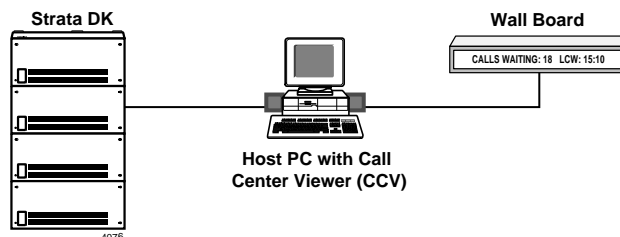

Figure 34 Direct Connection to DK424

Connection to Insight DK or SMIS

If a SMIS computer or MIS system is connected to the DK424 MIS port, the Call Center Viewer application host PC connects to it through a “Y” cable RS-232 splitter distribution box (see Figure 35). (Toshiba recommends model TL159A from Black Box® Corporation for this purpose.)

The Call Center Viewer monitors the connection between the Toshiba SMIS, MIS or another Call Center Viewer application PC. This enables the Call Center Viewer application PC to work in conjunction with the SMIS computer which is already connected to and controlling the DK424 MIS port.

The Call Center Viewer application and the SMIS application must reside on separate computers since SMIS requires a dedicated PC. The Call Center Viewer provides real-time status displays and connection of electronic Wall Boards, while SMIS provides historical ACD reports.

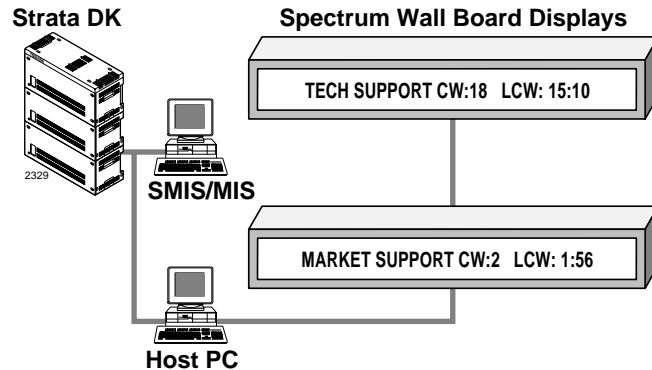

Figure 35 “Y” Splitter Connection

Multiple Supervisor Call Center Viewer Applications

By using RS-232 splitters in a “Y” cable distribution box connection (Toshiba recommends model TL159A from Black Box Corporation for this purpose), several PCs running the Call Center Viewer application can connect, in the monitor mode, to the DK424 MIS port (see Figure 36). This flexibility provides a variety of multiple Supervisor and electronic wall board connection configurations.

Each host PC Call Center Viewer application functions independently of the other connections. This functionality enables each group Supervisor to view real-time data associated with their particular group or all ACD groups.

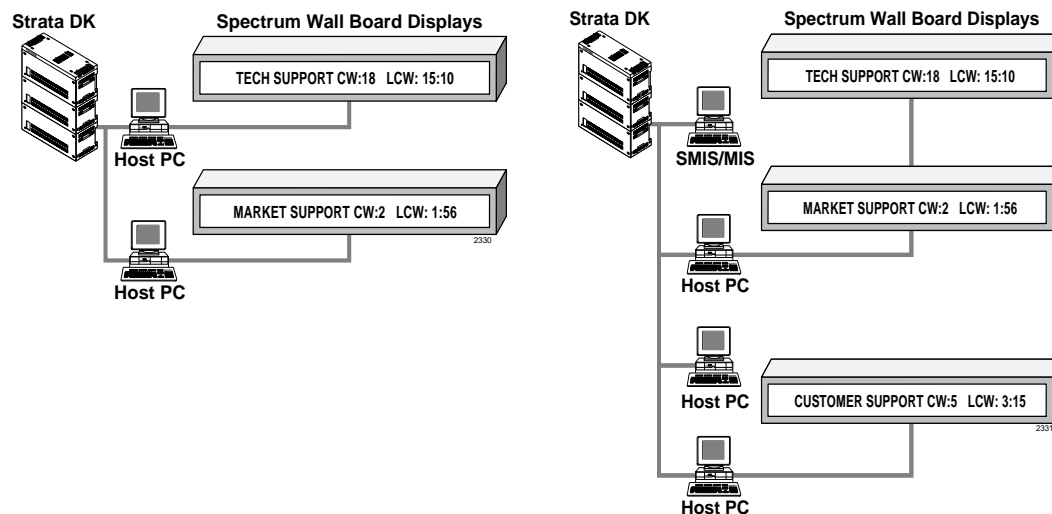

Figure 36 Multiple Supervisor Configurations

Spectrum Electronic Wall Boards

Electronic wall boards can be connected to the Supervisor's PC to display call center status data. This provides visibility of important call center event information to both Supervisors and Agents. The Supervisor can also send custom, user-defined text information to the electronic wall board which can be used for general information or motivational messages.

One copy of the Call Center Viewer application supports a wall board network which can cover all active ACD groups. The Call Center Viewer application works best with Spectrum 200 and 300 series wall boards.

Multiple Wall Boards

Multiple wall boards can be connected to the Call Center Viewer application PC. The boards can be assigned to individual ACD groups, to one ACD group, or multiple ACD groups can share one wall board.

Priority Text Messages

You can send Priority Text Messages from the Call Center Viewer application to an individual, a group, or all wall boards. You can use Priority Messaging for motivational messages (i.e., Congratulations We Made the Numbers) or informing the group of current priorities (i.e., Meeting at 2:00). When a Priority Message displays, all other messages including ACD information suspends for the duration of the Priority Message.

You can enter messages sent to the group at the host PC. When Priority Messaging is used frequently by a number of different Supervisors, we recommend configuring the Call Center Viewer application and wall board on each Supervisor's PC. This enables Supervisors to access real-time data and eliminates the need for the Supervisor to access the host PC (which could be unavailable) when sending their group a Priority Message.

Product Line Strategy

Call Center Viewer is an addition to the Strata DK product line and does not replace SMIS. Call Center Viewer provides real-time ACD status displays but not reports. For call center customers not needing reports, Call Center Viewer is ideal, because of its easy-to-use Windows format and concurrent operation with other applications. It is also a very cost-effective way of accommodating multiple ACD Supervisors and connecting electronic wall boards. Add SMIS when historical reporting is needed.

Cost-effective Incremental Growth

A major advantage of the Call Center Viewer is the ability to add ACD supervisory display and reporting capabilities when needed. This enables call center expansion to progress at the same pace as business growth.

- ♦ The Call Center Viewer application can be used by itself for call centers needing PC screen ACD group status visibility but not MIS reports.
- ♦ Electronic wall boards can be connected to the PC running the Call Center Viewer application to provide overhead messages.
- ♦ Additional Call Center Viewer applications can be added to support multiple ACD group and ACD call center Supervisor display applications.

- ♦ The Call Center Viewer can be used with Software MIS (SMIS) for call centers needing historical reports as well as real-time ACD group status displays.

ACD Software MIS (SMIS)

System Availability

Standard on Strata DK424 with ACD software and MIS port

SMIS was designed for small- to medium-sized ACD systems. It is entirely software-based, and can be run on an IBM 486 or compatible DOS computer. SMIS requires the Strata DK RKYS3 feature key, PPTC9 adapter, and a TTY interface circuit card (typically an RSIU PCB).

SMIS provides Supervisors with a wide variety of status, statistics, and traffic displays and reports used to monitor the performance of ACD groups and individual Agents. [Figure 37](#) shows the menu hierarchy of SMIS.

Note SMIS requires the DK RKYS3 feature key, PPTC9 adapter, and a TTY interface circuit card (typically an RSIU PCB).

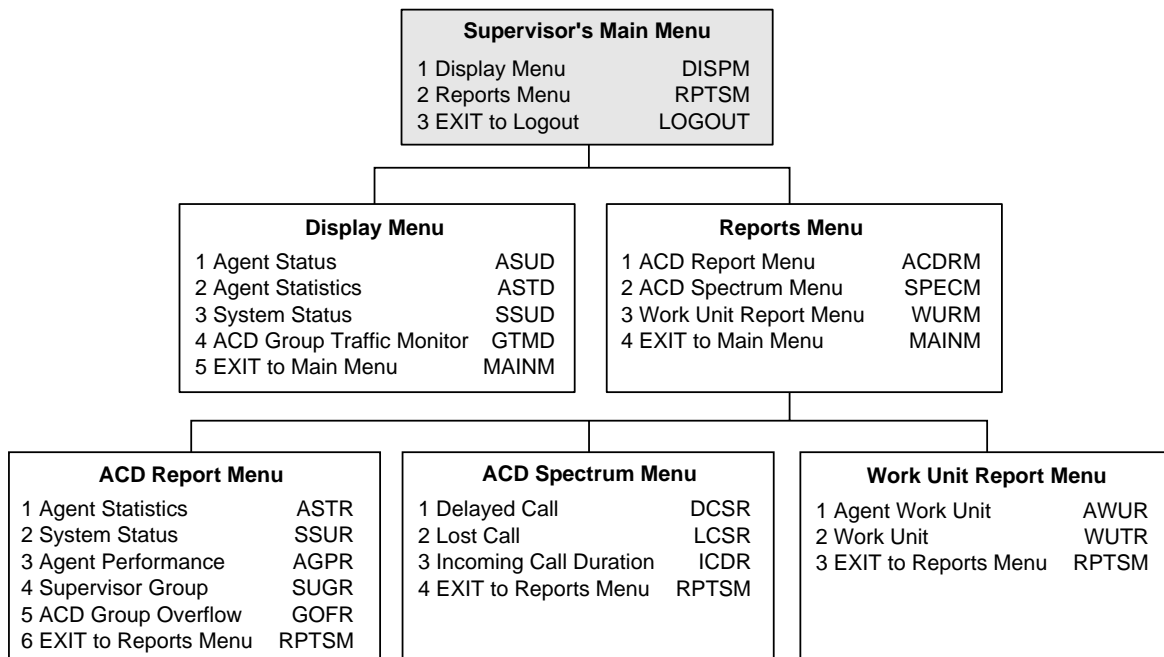

2067

Figure 37 SMIS Menu Hierarchy

SMIS System Configurations

SMIS must be installed on a dedicated 486 PC or above. The PC should have at least 4MB of RAM memory (16MB recommended), a 3.5 floppy-disk drive, a hard disk (100MB or larger), one serial and one parallel port, and a color monitor capable of displaying 25 lines of 80 characters each. For more details about SMIS, refer to the *SMIS Supervisor's Guide*.

Supervisor Displays

The SMIS provides Supervisors with a wide variety of status, statistics, and traffic displays used to monitor the performance of ACD Groups and individual Agents.

These real-time displays show the Supervisor what type of work the Agents are involved in; how efficiently the Group is handling incoming calls; how quickly calls are being answered; and how many calls were lost. The real-time displays are updated every few seconds.

The Supervisor terminal can use either color or monochrome monitors. Color monitors can be programmed to display important information in a variety of colors to further emphasize such things as alert levels that affect ACD Group performance, and current Agent status such as Agent available, Agent talking, Agent in After Call Work Time mode, and logged out or unavailable.

The following paragraphs describe the available Supervisor screens.

Agent Statistics

Displays the current status of each Agent within the ACD group, plus the accumulative call-processing information for that period. Included are:

- ♦ Number of calls waiting
- ♦ Longest call waiting
- ♦ Number of calls handled
- ♦ Average talk time
- ♦ Average After Call Work Time
- ♦ Average handling time (talk plus After Call Work Time)
- ♦ Available time
- ♦ Number of PBX calls originated and received Name and ID number, ACD group number
- ♦ Productivity percentages
- ♦ Auxiliary work (non-ACD) time

The display shows the totals of each Agent's statistics. It also shows group statistics, including the group-productivity percentage, and warns if the service level of the group is falling below acceptable levels. [Figure 38](#) is an example of the display.

09:25 6/10/97 Tuesday **Agent Statistics Display** ACD Group: 1

Number of Agents – Manned: 9 Busy: 4 Avail: 1 Unavail: 4

CW: 1 TM: 10

Agent No.	Name	Current Status	Stat Time	Work Unit	Call Hndl	Average Talk	ACW	Hndl	Avail Time	Aux. Work	Non-ACD	% Prod
401	Jane	Unavail	0:26		0	0	0	0	0:26	0:00	0	100
402	Robert	Talk	0:03	55	0	0	0	0	0:18	0:00	0	32
403	Alan	Unavail	6:33		1	565	44	609	1:30	0:00	0	64
404	Jeff	Unavail	9:40		2	240	25	265	0:00	0:00	0	48
405	Judy	Avail	2:36		1	465	44	509	0:00	0:00	0	100
406	Tom	Talk	3:15		1	189	67	256	2:48	0:00	0	75
407	Ted	Unavail	8:49		0	0	0	0	0:00	0:00	0	100
409	Ron	Aft Call	:45		2	485	0	485	1:53	0:00	0	93
414	Erin	Talk	4:45		3	320	23	343	4:40	0:00	0	81
Totals					10	251	22	273	1:16	0:00	0	77

SMIS

1972

Figure 38 SMIS Agent Statistics Display

Agent Status

Displays the current availability of each Agent within the ACD group. Included are the Agent’s ACD ID number, Agent’s name, current status, and Work Unit code, if used. Figure 39 is an example of the SMIS display.

09:25 6/10/97 Tuesday **Agent Status Display** ACD Group: 1

Agents No.	Name	Status	Stat Time	Work Unit	Agents No.	Name	Status	Stat Time	Work Unit
2401	Jane	Unavail	0:26		2402	Robert	Talk	0:03	55
2403	Alan	Unavail	6:33		2404	Jeff	Unavail	9:40	
2405	Judy	Avail	2:36		2406	Tom	Talk	3:15	
2407	Ted	Unavail	8:49		2409	Ron	Aft Call	0:45	
2414	Erin	Talk	4:45						

SMIS

1973

Figure 39 SMIS Agent Status Display

Group Traffic Monitor

Group Traffic Monitor displays real-time statistical information used by the Supervisor in evaluating ACD staffing requirements. Included are:

- ◆ Total calls offered, answered, overflowed, and lost

- ♦ Service-level percentage, average speed of answering, maximum delayed call (in seconds), current calls waiting
- ♦ Number of logged-in, busy, available, and unavailable stations

Three warning messages are displayed to indicate when the service level for a group is falling below the acceptable levels (e.g., service quality is low, bad, or unacceptable).

Figure 40 is an example of the display.

The screenshot shows a terminal window titled "ACD Group Traffic Display" with the date and time "11:16 6/10/97 Tuesday". It contains a table with the following data:

ACD Group	1	2	3	4
Offered	3	8	3	6
Answered	3	6	3	6
Oflo Ans	0	0	0	0
Lost	0	2	0	0
Serv Levl	100	86	100	100
A.S.A.	26	16	18	10
Long Wait	0	28	10	0
Calls Wait	0	2	1	0
Manned	3	6	2	3
Busy	1	3	2	0
Available	2	0	0	3
Unavail	0	3	0	0

SMIS
1979

Figure 40 ACD Group Traffic Display

System Status

Accumulative ACD group totals display that the Supervisor is enabled to view. Included for these groups are:

- ♦ Total number of calls offered, answered, overflowed, and lost
- ♦ Average talk time, after-call time, and handling time
- ♦ Total number of calls delayed (held in queue)
- ♦ Overall service level percentage
- ♦ Total current number of calls waiting to be answered (queue)
- ♦ Maximum number of calls in queue at one time
- ♦ Longest time (in seconds) that a call waited to be answered

See Figure 41 for an example of the display.

10:15 6/10/97 Tuesday ACD System Status Display

Grp No.	Srv Lvl	Calls Offd	-- Handled --		Calls -----		----- Average -----			----- Waiting -----		
			Prim	Oflo	Lost	Dely	Talk	Hndl	Dely	Curr	Max	Long
1	82	11	10	0	1	1	47	48	46	1	2	89
2	50	5	4	1	0	2	73	73	65	0	3	00

Totl	66	16	14	1	1	3	60	60	55	1	3	97

SMIS
2339

Figure 41 ACD System Status Display

Supervisor Reports

The Supervisor can run a number of reports that provide information and statistics on individual Agents, ACD Groups, or the system status over a selectable time period. Each report can cover the following time periods: periods (60 minutes), shift, daily, weekly, monthly, and yearly (up to two years). The time frame used to compile the report is shown at the top of each report. The overall total (or average) for each item on the report is included at the end of the report.

The SMIS and Strata DK systems provide the following reports. These reports have the same layout when printed or displayed. SMIS can differentiate between PBX calls made to an internal or an external destination. However, Strata DK reports all outbound calls to the SMIS the same way. Because of this, all outbound call data is collected and reported as Originated Internal PBX Calls.

Agent Performance

The Agent Performance Report (see [Figure 42](#)) provides call processing and after-call-activity information for all Agents within an ACD group. This report can be used for evaluating the performance of each Agent in relation to other Agents in the group. Included on the report are:

- ◆ Agents' ID numbers and names
- ◆ Total log in times
- ◆ Number of ACD calls handled
- ◆ Number of PBX calls handled (DK424 Release 3)
- ◆ Average ACD talk, work-handling times, and available times

Agent Performance Report—Daily											Page 1	
00:00 6/10/97		ACD Group: 1										
23:59 6/10/97												
ACD Group Related Work											PBX Work	
											Originated	
Agent No.	Agent Name	Login Time (Hrs)	Calls Handled	Avg Talk (Sec.)	Avg Work (Sec.)	Avg Hndng (Sec.)	Avail Time (Hr.)	Agnt Prod (%)	Aux. Work (Hr.)			Avg Dur (Sec.)
4104	Ed	7.1	19	254	44	298	1.3	40.46	0.0			0
4105	June	7.7	17	272	36	308	0.7	27.98	0.0			0
4106	Tom	7.9	39	309	40	349	3.1	88.48	0.0			0
4108	Keith	7.8	33	300	31	331	1.3	55.96	0.0			0
4114	Sally	7.9	42	411	5	416	1.5	80.65	0.0			0
Totals:		38.7	150	309	31	340	8.0	62.45	0.0			0
Grand:		38.7	150	309	31	340	8.0	62.45	0.0			0

SMIS

1978

Figure 42 SMIS Agent Performance Report - Daily

Agent Statistics

This report summarizes the performance of individual Agents (see Figure 43). The information regarding the Agent includes:

- ◆ Name, ID number, and ACD group number
- ◆ Productivity percentage, number of calls per hour, number of work unit codes entered, and number of Supervisor assistance calls
- ◆ Total log in time, talk time, after call work time, available and unavailable time
- ◆ Number of ACD and PBX calls received and originated, and the average length of the calls

Note All Agent calls originated are reported in the “Internal” section of PBX calls. “Originated External is left blank.

Agent Statistics Report—Daily											Page 6		
00:00 6/10/97		Agent # : 4106 Name: TOM ACD Group: 1											
23:59 6/10/97		Prod % : 88.48 ACD Calls/hr : 4.9 WU PEG Cnt: 14											
Hours Breakdown											PBX Work		
ACD Group Related Work											Originated		
Login Time	Talk Time	After Call	Avail Time	Unav Time	Aux. Work			Intern	Extern	Hold			
7.9	3.4	0.4	3.1	0.9	0.0			0.0	0.0	0.0			
	43.0%	5.3%	39.0%	11.5%	0.0%			0.0%	0.0%	0.0%			
Call Analysis											PBX Work		
ACD Group Related Work											Originated		
Calls Handled	Avg Talk Sec.	Avg Work Sec.	Avg Hndng Sec.					Internal Number	External Number	External Sec.			
39	309	40	349					0	0	0			

SMIS

1990

Figure 43 ACD Agent Statistics Report

Delayed Call

This report provides a summary of all calls offered to a group versus totals and percentages of calls handled, calls delayed, and percentages of calls answered within predefined time increments. See [Figure 44](#) for an example.

This information can be compared to other reports, such as Agent Statistics and System Status Reports, to see if Agents are working efficiently, and if staffing is adequate.

00:00 6/10/97		Delayed Call Spectrum - Daily														Page 1				
23:59 6/10/97		ACD Group: 1																		
Time	No	No	No	%	Avg	Max	Percent Calls Handled Within x sec.													
HHMM	Calls	Calls	Calls	%	Dly	Dly	2	4	6	8	13	18	23	28	33	43	53	63	63+	
	Offrd	Hndld	Dlyd	Dlyd																
6:00	6	6	6	100	8	12	0	0	0	50	50	0	0	0	0	0	0	0	0	
7:00	21	21	21	100	76	376	0	5	10	10	0	10	14	5	0	5	10	0	31	
8:00	17	15	15	100	104	330	0	0	7	7	0	0	7	0	0	7	7	13	52	
9:00	20	19	19	100	58	326	0	0	0	26	16	11	5	5	0	16	5	0	16	
10:00	20	19	18	95	67	339	5	11	5	5	16	11	0	0	5	5	0	5	32	
11:00	17	17	17	100	81	371	0	6	12	0	6	12	12	6	0	6	0	0	40	
12:00	24	21	21	100	140	529	0	5	5	10	0	5	5	0	5	0	10	0	55	
13:00	12	12	12	100	37	133	0	8	0	0	17	8	25	0	0	0	8	25	9	
14:00	18	8	8	100	410	1284	0	0	0	0	13	0	0	0	13	0	0	0	74	
15:00	13	10	10	100	1340	2132	0	0	0	0	0	0	10	0	0	0	0	0	90	
Total	168	148	147	99	211	2132	1	4	5	9	8	7	7	3	1	5	5	4	41	

SMIS

1991

Figure 44 SMIS Delayed Call Spectrum - Daily

Group Overflow

Overflow information is used to determine under-staffing and over-staffing conditions. This report (see [Figure 45](#)) summarizes the calls to the group and displays primary and secondary traffic for comparison purposes. Included in the report are:

- ✦ ACD group number
- ✦ Number of calls offered
- ✦ Percentage of calls handled, lost, and overflowed to another group

00:00 6/10/97		ACD Group Overflow Report - Daily			Page 1
23:59 6/10/97		ACD Group: 1			
Time HHMM	Calls Offered	Primary Handled (%)	Calls Lost (%)	Ovfl (%)	
600	6	100.00	0.00	0.00	
700	21	100.00	0.00	0.00	
800	17	88.24	11.76	0.00	
900	20	95.00	5.00	0.00	
1000	20	95.00	5.00	0.00	
1100	17	100.00	0.00	0.00	
1200	24	87.50	12.50	0.00	
1300	12	100.00	0.00	0.00	
1400	18	44.44	55.56	0.00	
1500	13	76.92	23.08	0.00	
Totl	168	88.71	11.29	0.00	

SMIS

1975

Figure 45 SMIS ACD Group Overflow Report - Daily

Incoming Call Duration

Call duration statistics for a specified ACD group are provided by this report (see Figure 46). The report is useful in determining staffing requirements and modifying acceptable service levels for each group. Information included is:

- ◆ Number of calls handled
- ◆ Average duration of calls
- ◆ Longest single-call duration
- ◆ Percentage of calls answered within predefined time periods (in seconds)

00:00 6/10/97		Incoming Call Duration Spectrum - Daily													Page 1	
23:59 6/10/97		ACD Group: 1														
Time HHMM	No Calls Hndld	Avg Dur (sec)	Max Dur (sec)	Percent Calls Lasting Less Than x sec. -----												
				10	20	30	40	60	80	100	120	140	170	200	230	230+
6:00	6	298	521	0	0	0	0	0	17	17	0	0	0	0	0	66
7:00	21	241	848	5	0	5	0	10	0	10	0	10	5	0	14	41
8:00	15	372	979	0	0	0	0	7	7	7	0	0	0	0	7	65
9:00	19	345	1453	0	0	0	0	5	11	0	11	5	5	11	11	41
10:00	19	353	1334	0	0	0	5	5	5	5	0	11	0	0	0	64
11:00	17	311	1143	6	0	12	0	6	0	0	0	6	12	0	0	58
12:00	21	328	1046	0	0	0	0	0	5	10	10	0	0	14	5	56
13:00	12	210	441	0	0	0	8	0	0	0	8	25	0	8	8	43
14:00	8	563	1429	0	0	0	0	0	0	0	0	13	13	0	0	74
15:00	10	369	811	0	0	0	0	0	10	0	10	0	10	0	10	60
Total	148	329	1453	1	0	2	1	4	5	5	5	5	5	5	6	56

SMIS

1976

Figure 46 SMIS Incoming Call Duration Spectrum - Daily

Lost Call

Provides a summary of calls that were disconnected before being answered or that left the queue after the queue timer period expired (see [Figure 47](#)). Percentages are calculated based on 13 time intervals (defined by the System Administrator).

This information is useful when determining the length of waiting periods before delay announcements are given, or ACD calls overflow into another group. The Caller ID and ANI numbers of callers that hang up while waiting in queue are not shown on the Lost Call report. These numbers are stored in system memory and can be displayed at a Supervisor telephone or other designated LCD telephone.

00:00 6/10/97		Lost Call Spectrum - Daily													Page 1				
23:59 6/10/97		ACD Group: 1																	
Time	No	No	Avg	Max	Percent Calls Lost Within x Seconds														
HHMM	Calls	Calls	%	Lost	Lost	2	4	6	8	13	18	23	28	33	43	53	63	63+	
	Offrd	Lost	Lost	Dly	Dly														
6:00	6	0	0	0	0	0	0	0	0	0	0	0	0	0	0	0	0	0	0
7:00	21	0	0	0	0	0	0	0	0	0	0	0	0	0	0	0	0	0	0
8:00	17	2	12	69	121	0	0	0	0	0	50	0	0	0	0	0	0	0	50
9:00	20	1	5	32	32	0	0	0	0	0	0	0	0	100	0	0	0	0	0
10:00	20	1	5	98	98	0	0	0	0	0	0	0	0	0	0	0	0	0	100
11:00	17	0	0	0	0	0	0	0	0	0	0	0	0	0	0	0	0	0	0
12:00	24	3	13	280	445	0	0	0	0	0	0	0	0	0	0	0	0	0	100
13:00	12	0	0	0	0	0	0	0	0	0	0	0	0	0	0	0	0	0	0
14:00	18	10	56	333	609	0	0	0	0	0	0	0	10	0	0	0	0	0	90
15:00	13	3	23	386	852	0	0	0	0	0	0	0	0	0	0	0	0	0	100
Totl	168	20	12	109	852	0	0	0	0	0	5	0	5	5	0	0	0	0	85

1993

Figure 47 SMIS Lost Call Spectrum - Daily

Supervisor Group

The Supervisor's Group report provides call processing and after-call activity information for ACD groups. The report is similar to the Agent Performance report except that instead of detailing each Agent's statistics, group totals based on a requested time frame are shown.

Daily reports reflect each hour in the day. Monthly reports reflect each day in the month. Yearly reports reflect each month in the year. All Agent calls originated are reported in the Internal section of PBX calls. Originated External is blank. See [Figure 48](#) for an example.

00:00 6/10/97		ACD Supervisors Group Report—Daily										Page 1	
23:59 6/10/97		ACD Group: 1											
Time HHMM	Login Time (Hrs)	ACD Group Related Work					PBX Work					Total Agents Manned	
		Calls Handled	Avg Talk (Sec.)	Avg Work (Sec.)	Avg Hndng (Sec.)	Avail Time (Hrs.)	Aux. Work (Hrs.)	Agnt Prod	Received Calls	Avg Dur (Sec.)			
500	1.0	0	0	0	0	0.0	0.0	0.00	0	0	0	0	
600	2.3	6	298	44	342	1.2	0.0	76.9	0	0	0	0	
700	3.0	21	242	40	282	1.2	0.0	94.8	0	0	0	0	
800	4.7	15	373	27	400	0.8	0.0	52.4	0	0	0	0	
900	5.0	20	329	31	360	1.2	0.0	64.0	0	0	0	0	
1000	5.0	19	354	33	387	0.9	0.0	58.8	0	0	0	0	
1100	5.0	17	311	23	334	0.9	0.0	49.6	0	0	0	0	
1200	5.0	21	328	24	352	0.3	0.0	47.0	0	0	0	0	
1300	4.7	13	195	34	229	1.2	0.0	43.1	0	0	0	0	
1400	2.4	8	564	4	568	0.0	0.0	52.5	0	0	0	0	
1500	2.0	10	370	10	380	0.1	0.0	57.7	0	0	0	0	
Totals:	40.0	150	326	27	363	7.8	0.0	65.7%	0	0	0	0	

Figure 48 SMIS ACD Supervisors Group Report - Daily

System Status

Figure 49 shows the system status report. It summarizes the call handling characteristics of a group during the current report interval. Statistics include:

- ◆ Number of calls offered, answered, overflowed, and lost
- ◆ Average talk time, after-call time, and handling time
- ◆ Number of calls delayed (held in queue)
- ◆ Service level percentage
- ◆ Average and maximum delay time
- ◆ Maximum number of calls in queue at one time.

00:00 6/10/97		System Status Report - Daily										Page 1	
23:59 6/10/97		ACD Group: 1											
Time HHMM	Number of Calls				Avg Length			Delayed Call Information					
	Offered	Primary Handled	Overflow	Lost	Talk Time (sec.)	After Call (sec.)	Hndng Time (sec.)	Calls Delayed	Serv. Level (%)	Avg Delay (sec.)	Max Delay (sec.)	Max In Queue	
600	9	8	0	1	314	30	344	7	11.1	190	323	3	
700	10	10	0	0	378	26	404	7	30.0	133	289	3	
800	27	25	0	2	703	17	720	15	37.0	100	369	4	
900	24	24	0	0	641	32	673	16	33.3	78	473	4	
1000	26	26	0	0	396	21	417	15	42.3	64	261	3	
1100	23	19	0	4	404	25	429	6	56.5	53	309	5	
1200	20	20	0	0	441	31	472	13	35.0	149	370	3	
1300	16	13	0	3	391	23	414	9	25.0	250	678	8	
1400	23	20	0	3	614	20	634	18	8.7	438	1116	4	
1500	14	12	0	2	622	24	646	7	35.7	73	220	3	
1600	1	1	0	0	694	1	695	0	1.0	15	15	0	
TOTL	193	178	0	15	514	23	539	113	33.7	145	1116	8	

Figure 49 SMIS System Status Report - Daily

Work Unit

Work Unit codes are established by each customer to represent types of call activities that an Agent may be involved in. These two-digit codes are entered from the Agent’s telephone dial pad during an ACD call. This information is helpful when modifying the distribution of certain types of calls. See [Figure 50](#) for the Agent Work Unit report and [Figure 51](#) for the ACD Work Unit report. Both reports are daily totals.

00:00 6/10/97		Agent Work Unit Report—Daily			Page 2
23:59 6/10/97		ACD Group: 1			
Agent No.	Agent Name	Work Unit	PEG Count	Calls Handled	
2522	ROBERT	07	3	1	
2522	ROBERT	08	1	1	
2522	ROBERT	12	4	1	
2522	ROBERT	88	1	1	
2522	ROBERT	99	1	0	
Agent Total:			10	4	
Group Total:			27	7	
Grand Total:			27	7	

SMIS

1980

Figure 50 SMIS Agent Work Unit Report - Daily

00:00 6/10/97		ACD Work Unit Report—Daily			Page 1
23:59 6/10/97		ACD Group: 1			
Work Unit	PEG Count	Calls Handled			
01	1	0			
03	1	0			
07	3	0			
08	1	0			
09	1	0			
11	2	1			
12	5	2			
14	1	0			
15	1	0			
41	1	0			
45	1	0			
50	1	0			
52	2	2			
53	1	0			
55	1	0			
66	1	0			
88	1	0			
99	2	2			
Total:	27	7			

SMIS

1989

Figure 51 SMIS ACD Work Unit Report - Daily

Hospitality Management Information System

6

Hospitality Management Information System (HMIS) is optional with Strata DK40i and DK424 systems. HMIS cannot be connected to the Strata DK14.

The Toshiba Strata DK HMIS is a PC-based solution, designed to meet the specific operational needs of small- to medium-sized hotel/motels. HMIS tightly integrates with the Strata DK Digital Telephone System, Release 3.1 or higher, and the Strategy Voice Processing System, providing a complete and fully-integrated hospitality package.

The HMIS is a turnkey package that includes both the PC and software. Multiple PCs (one server PC and from one to nine workstation PCs) can be networked to function as multiple front desk terminals.

Both the server and workstation PCs are specific to the HMIS application requirements. The HMIS PC is dedicated to running the HMIS application. For optimum performance, other programs *should not* be installed on the HMIS PC.

The HMIS is available on two different PC platforms, at different prices and performance levels.

- ♦ A lower-priced generic brand PC server and workstation is available at the current published prices:

	Server PC	Workstation PC
Intel® Pentium® 133 MHz (or higher) Processor	✓	✓
Windows® 95	✓	✓
RAM	32MB	16MB
2GB Hard Drive	✓	✓
3.5" 1.44 MB Floppy-disk Drive	✓	✓
2 Serial Communication Ports	✓	✓
10Base-T Network Card	✓	✓
14" SVGA Color Monitor	✓	✓
Keyboard and PS/2 Mouse	✓	✓
Windows Graphics Accelerator	✓	✓
33.6 kbps Internal Modem (used for remote access to the HMIS for troubleshooting)	✓	
8x-speed CD-ROM Drive	✓	
Symantec™ pcANYWHERE™ software	✓	

- ♦ A slightly higher-priced Toshiba Equium PC server and workstation is also available to provide higher performance and higher quality PC equipment:

	Server PC	Workstation PC
Intel® Pentium-II 266 MHz (or higher) Processor	✓	✓
Windows 95	✓	✓
32MB RAM	✓	✓
3GB Hard Drive	✓	✓
3.5" 1.44 MB Floppy-disk Drive	✓	✓
Serial Communication Ports	2 ports	1 port
10Base-T Network Card	✓	✓
15" SVGA Color Monitor	✓	✓
Keyboard and PS/2 Mouse	✓	✓
33.6 kbps Internal Modem (used for remote access to the HMIS for troubleshooting)	✓	
24-speed CD-ROM Drive	✓	
Symantec™ pcANYWHERE™ software	✓	

Using a powerful PC provides excellent processor speed and performance of the HMIS application.

The HMIS application provides hotel/motel features and property management capabilities that are not resident within the Strata DK telephone system. The HMIS is well integrated with the telephony features of the Strata DK telephone system to which it is attached.

The Strata HMIS provides guest check-in/check-out, up to 20-year reservation capacity, automatic wake-up calls, SMDR telephone call tracking and costing, billing, telephone system control, and many other features (see [Figure 52](#)).

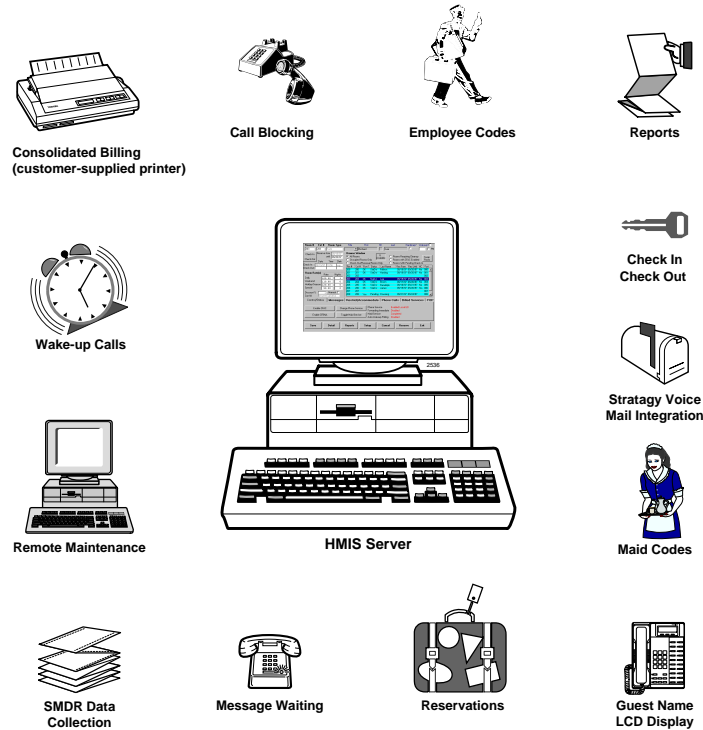

Figure 52 HMIS Applications

Hardware Configurations

There are two configurations of the HMIS product:

- ♦ An HMIS server acting as a single front desk terminal (see [Figure 53](#) below).

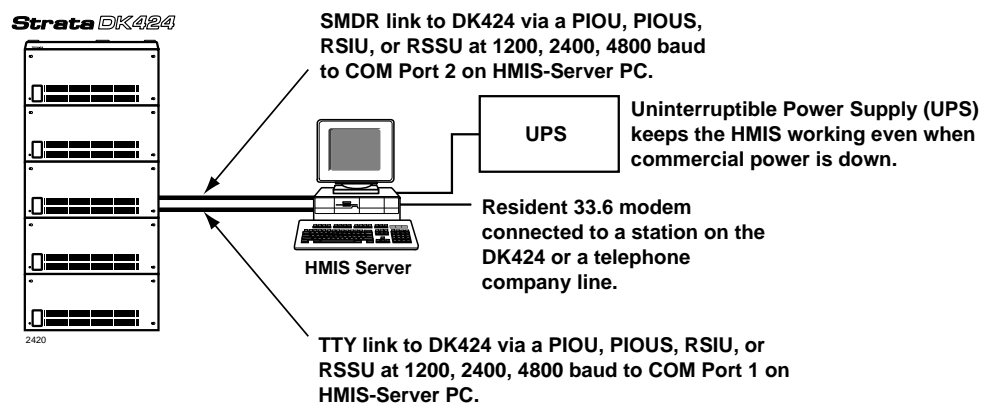

Figure 53 HMIS Server PC

- ♦ An HMIS server with HMIS workstation PCs networked on a LAN to function as multiple front desk terminals (see Figure 54 below and “Multiple Front Desk PC Terminals” in the HMIS General Description). The configuration includes a five-port network hub which can support up to four workstations. Up to nine workstations can be connected using either a larger or multiple hubs.

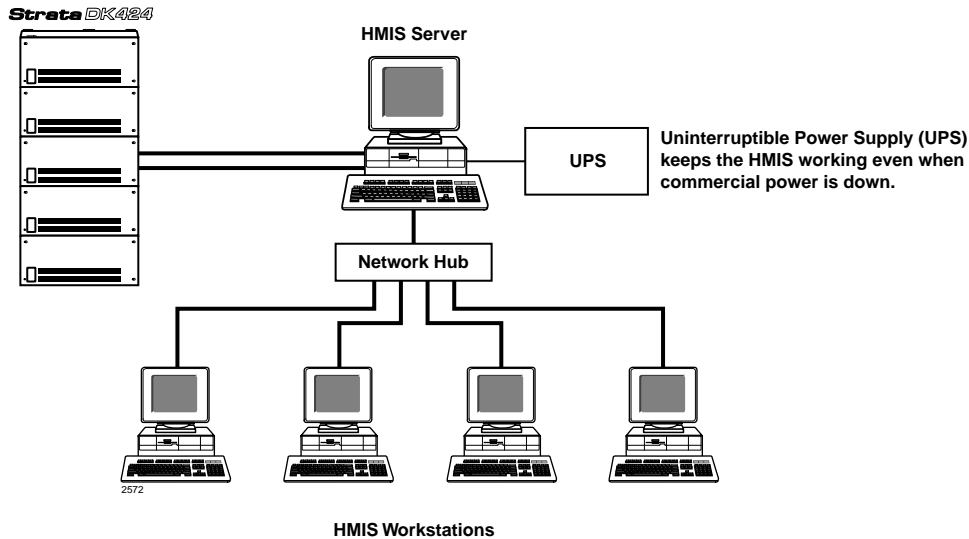

Figure 54 Server PC with Workstations

The hardware/software included with the server and workstation are well-adapted for their specific uses. Using a powerful PC provides excellent processor speed and performance of the HMIS application.

Table 22 HMIS PC/Software Specifications

Server PC	Workstation PC
IBM-compatible Pentium 133 MHz Processor	IBM-compatible Pentium 133 MHz Processor
Windows 95	Windows 95
16MB RAM	16MB RAM
2GB Hard Drive	2GB Hard Drive
3.5" 1.44 MB Floppy-disk Drive	3.5" 1.44 MB Floppy-disk Drive
3 Serial Communication Ports	3 Serial Communication Ports
10Base-T Network Card	10Base-T Network Card
14" SVGA Color Monitor	14" SVGA Color Monitor
Windows 95 Keyboard and PS/2 Mouse	Windows 95 Keyboard and PS/2 Mouse
Windows Graphics Accelerator	Windows Graphics Accelerator
8-speed CD ROM Drive	
33.6 Internal Modem (used for remote access to the HMIS for troubleshooting)	
Symantec™ pcANYWHERE™ software	
Uninterruptible Power Supply (UPS)	

Connection Requirements

The HMIS connects to the Strata DK using two connections, the TTY port and SMDR port on a PIOUS, PIOUS, RSIU, or RSSU at 1200, 2400, or 4800 baud. If SMDR is also used for general purposes, in addition to hotel guest billing records, it requires a customer-supplied Y-connector to the general purpose printer or call accounting device.

The Automatic Wake-up Call function provided by HMIS has some specific Strata DK system requirements. They are:

- ♦ One digital station port must be available for connection to a digital telephone that is dedicated to the auto wake-up function. This telephone and port is not used for any other purpose. The customer's system must provide the available digital station port.
- ♦ An external music or message source is required to play the optional music or greeting to guests who receive auto wake-up calls. This requires a customer-supplied music source or digital announcer to play the greeting, and a standard station port on an RSTU2 or RDSU card.

Main Screen

All screens and pop-up dialog boxes are accessed from the Main screen which serves as the central point for the system. To make a reservation or check in/check out a guest, simply click on a button from this screen to start the process. Entries made on other screens are automatically incorporated into the HMIS databases and immediately displayed on the Main screen, providing a complete and up-to-date record of business activity.

On-screen Guest Directory

The HMIS Main screen provides an on-screen guest directory (see [Figure 56](#)). The information displayed includes the room number, room telephone extension, room type, reservation dates, room rates, handicap indicator, check-in date/time/clerk ID, and confirmation number.

Browse Window

The Browse Window (see [Figure 55](#)) enables the authorized user to search the HMIS quickly and easily. By clicking on the column heading, information can be sorted by any column displayed on the screen. Or, you can sort the Window by any of the following categories:

- ♦ All rooms (list of all rooms—designates occupied rooms and reserved rooms with pending check-in).
- ♦ Occupied rooms only (list of rooms with checked-in guests).
- ♦ Check-out/renewal rooms only (list of rooms due for check-out or renewal on current date).
- ♦ Rooms requiring cleanup (list of rooms scheduled for cleanup).
- ♦ Rooms with DND enabled (list of rooms where call blocking is enabled)
...or, where Strategy is installed, rooms with CFAC enabled (list of rooms where all calls are forwarded to Strategy).
- ♦ Rooms with pending check-in (list of reserved rooms due for check-in on current date).

The operator can browse room availability or status such as a list of all rooms, occupied rooms, rooms requiring check-out, rooms requiring cleanup, rooms pending check-in, rooms with DND or

Call Forward – All Calls (CFAC) set. There is a Swap Room button (see “Room Change (Swap) in the HMIS General Description) for changing a guest’s room quickly and easily.

When the All Rooms option is selected, the window displays the entire hotel guest list. The Browse function is very useful during check-in for locating guest reservations.

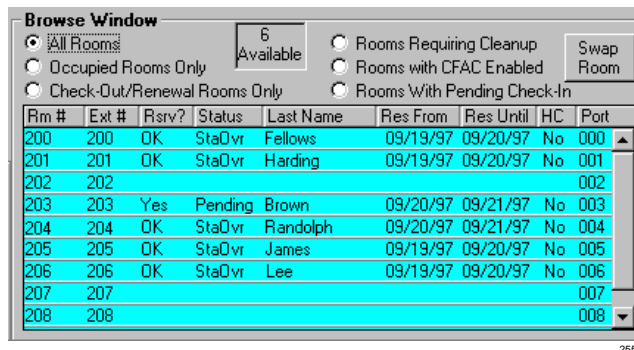

Figure 55 Browse Window (with sample data)

Customer Detail Window

The Detail button at the bottom of the screen provides a toggle feature between the Browse and Customer Detail Windows. The Customer Detail Window displays the following information about the guest:

- ♦ Home address/telephone number
- ♦ Auto make/model
- ♦ Auto tag #
- ♦ Company affiliation (name/telephone number)
- ♦ Number of adults/children in party
- ♦ Any special comments

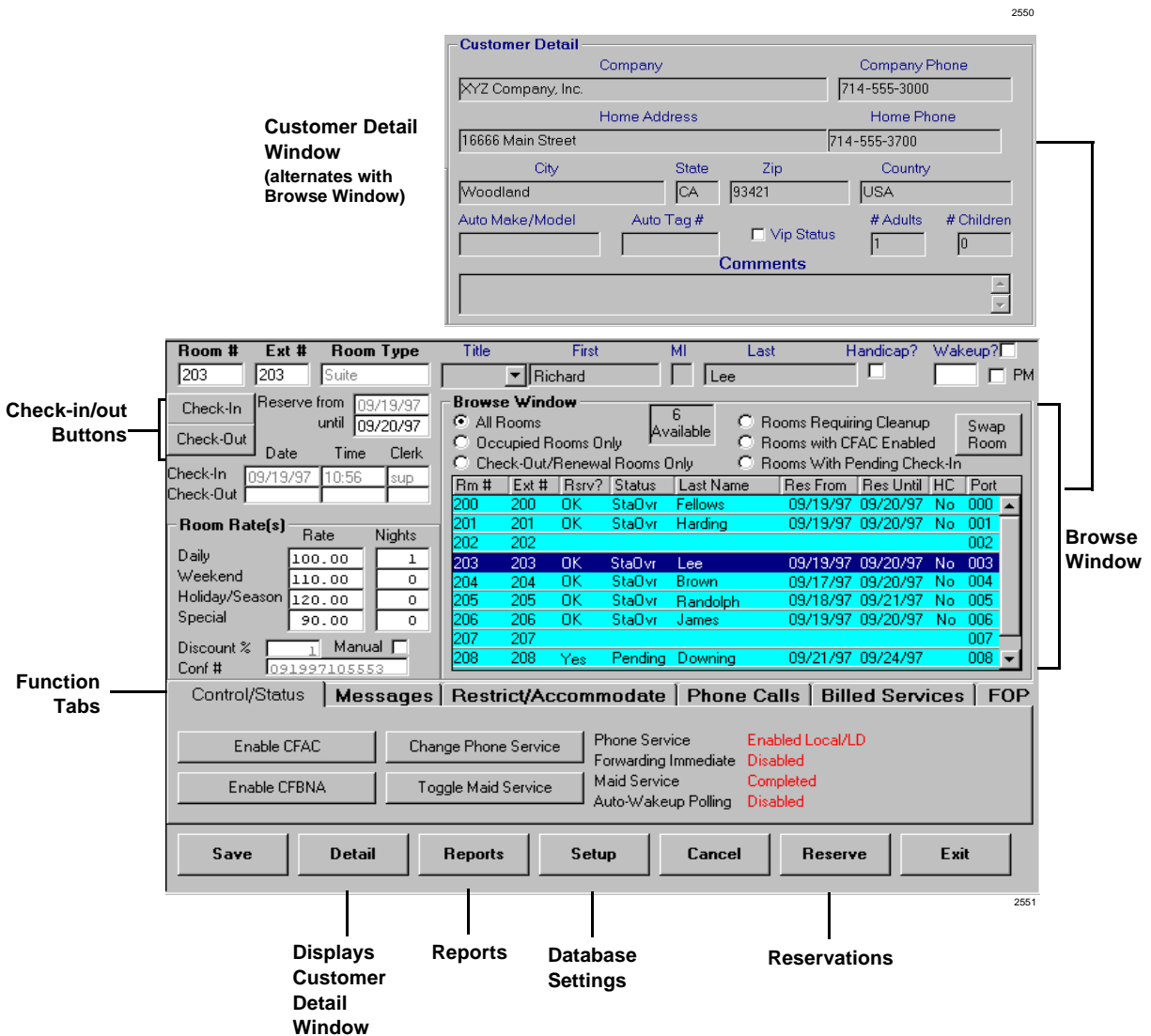

Figure 56 HMIS Main Screen (with sample data)

Function Tabs

Dialog boxes are provided in the bottom half of the Main screen. The tabs enable the front desk clerk to enter guest or room information during the guest’s stay and view the data, whenever necessary. The tabs are described below.

- ♦ Control/Status – Manually controls and displays telephone service, call forwarding or Do Not Disturb (DND), maid service and wake-up call settings for the room.
- ♦ Messages – Enables entry of messages and tracks wake-up calls for each room. Messages can be printed at any time and remain in the database until the Clear Msgs/Wakeup Logs button is selected or the guest checks out. A log of wake-up calls is also displayed and can be cleared with the same button.
- ♦ Restrict/Accommodate – Displays amenities (cable, TV, etc.) and special conditions (baby crib, etc.).
- ♦ Phone Calls – Tracks telephone calls/charges on a per room basis.

- ◆ Billed Services – Enables entry of billed service charges for room service, movies, etc. to the guest's account and displays all entries during the guest's stay.
- ◆ FOP – Registers and displays the Form of Payment (FOP) that is being used by the guest (cash, check or credit card) and room deposit payment.

Convenient Access to Screens/Functions

The HMIS Main screen provides button access to the functions and menus required to run the hospitality facilities.

- ◆ Check-in – Displays the Check-in screen. The screen enables the front desk staff to check in either a walk-in or reservation guest (see [“Check-in” in the HMIS General Description](#) for details). An Available Room Selection pop-up dialog box provides a list of rooms from which to choose.
- ◆ Check-out – Displays the Billing Statement screen. By highlighting a guest's name in the Browse Window and clicking on this button, front desk staff can view/print the guest's consolidated billing statement. Clicking on the Payment Received button clears the account and the database of guest information, sets the Maid Service to “Required” and the telephone service to “outgoing call restriction” (see [“Check-out with Billing” in the HMIS General Description](#) for details).
- ◆ Reserve – Displays the Reservation screen. This screen enables the front desk clerk to make guest reservations. An Available Room Selection pop-up dialog box provides a list of rooms from which to choose (see [“Reprinting Processed Billing Statements” in the HMIS General Description](#) for details). During System Setup, the authorized user can choose between reservation databases that can store 4, 8, 12, 16, or 20 years of reservation records.
- ◆ Reports – Displays the Report Menu screen. This screen enables authorized personnel to view/print a list of seven reports: Hotel Guest List, Maid Activity Report, Reservation List, Uncleared Outgoing Phone Calls Made, Morning Check Out List, All Active Balance Statements, and Consolidated Detail Night Audit Report (see [“Reports” in the HMIS General Description](#) for detailed information).
- ◆ Setup – Displays the Setup Menu screen. This screen enables authorized personnel to access a group of six setup screens that must be completed before HMIS can be used. The screens consist of: Master Room and AutoGen Setup screens for room record entries, Company for entry of company information (name, address, etc.), Employee Codes for entry of staff names/category/employee ID, Settings for telephone/tax settings, and Statement for customizing the billing statement printout.

User-definable Settings

The HMIS application has user-definable settings, enabling the hotel/motel management to tailor-make the application to suit the business' individual needs.

For more information, refer to *Hospitality Management Information System (HMIS) User Guide* and *General Description*.

Glossary

Term	Definition
AA	Auto Attendant (built-in or external) – acts as an automatic operator that directs incoming callers to stations by offering a menu of dialing prompts.
ABR	Automatic Busy Redial – enables a station user to automatically redial a busy outside number up to 15 times at pre-programmed intervals.
ACB	Automatic Callback – enables the station user, using a flexible button or dialing a special code, to call back a station that was previously busy or in DND mode. When the called station is free, the system rings the caller with a special tone.
ACD	Automatic Call Distribution – enables incoming calls to be distributed to a group of ACD agents. The ACD Supervisor's LCD telephone displays ACD Agent and Group information which allows the Supervisor to monitor calls and assist agents.
ADM	Add-on Module – See <i>DADM</i> .
AMI	Alternate Mark Inversion.
ANI	Automatic Number Identification – sends the phone number of the calling party to the Strata DK system over incoming DID or tie lines. This feature is provided by some long distance telephone service companies.
B Channel	Bearer Channel – ISDN data or voice channel which transmits at 64kpbs. It refers to the frequency range of transmissions on a copper pair and is a logical, rather than a physical channel. Also see BRI and PRI.
B8ZS	Bipolar 8 Zero Substitution.
BGM	Background Music – enables customer-supplied music to be sent to telephone speakers and external speakers.
BLF	Busy Lamp Field.
BPS	Bits Per Second – unit of measure that refers to the transmission speed (baud rate) of electronic signals. It describes the Data Interface Unit (DIU) and modem operation.
BRI	Basic Rate Interface – ISDN line with 2B + 1D channel. BRI lines can have a U-interface with RJ-11 jacks and single twisted pair wiring, or RJ-45 four pair S/T interface wiring. BRI is the a smaller ISDN interface than PRI.
BSIA	Base Station Interface Adapter – Strata AirLink Wireless Controller.
CESID	Caller's Emergency Service Identification – phone number for specific station or station location which is sent to the CAMA trunk.
CFAC	Call Forward-All Calls – forwards all calls when a station is idle or busy. The station does not ring.
CFB	Call Forward-Busy – forwards all calls when a station is busy.
CFNA	Call Forward-No Answer – forwards all calls when a station does not answer. The "No Answer" time is flexible, 8 to 60 seconds.
CFBNA	Call Forward-Busy/No Answer – forwards all calls when a station is busy or doesn't answer. Calls ring for 8 to 60 seconds and then forward.
CLASS	Custom Local Area Signaling Services – defines a number of features offered by local telephone companies.
CLID or CND	Calling Line Identification or Calling Number Delivery – phone number or name of the calling party sent to the Strata DK system over incoming ground or loop start CO lines. This feature is one of the "CLASS" features offered by some local telephone companies.

Term	Definition
CNIS	Calling Number Identification Services – caller ID for ISDN. CNIS is calling party information for outgoing and incoming calls sent to the ISDN network.
CO	Central Office – facility which houses switching equipment that provides phone service (CO lines, E & M tie lines, DID lines, Centrex lines) for the immediate geographical area.
CODECs	Coder/Decoder – semiconductors that process analog-to-digital and digital-to-analog conversions.
CSU	Channel Service Unit – required between the DK PRI interface and the PRI line provider interface in most locations of the U.S.
CTI	Computer Telephony Interface – combines the capabilities of the Strata DK digital business telephone system with custom functionality provided by computer applications. The PC must be running Microsoft Windows software.
D Channel	ISDN Data Channel – transmits call control information (out-of-band signaling) for B-channels. The D-channel is a logical, not physical channel.
DADM	Digital Add-on-Module – provides 20 flexible feature buttons that can be assigned individually for Direct Station Selection, System and Personal Speed Dial, and CO line access. Connects to 2000-series digital telephones.
DDCB	Digital Door Phone/Lock Control Unit – supports optional door phones (MDFBs) and provides door lock control. A peripheral hardware unit compatible with designated digital telephone circuits.
DDSS	Digital Direct Station Selection Console – facilitates the processing of heavy loads of incoming calls. The DDSS connects only to designated digital telephone circuits and is associated with a digital telephone.
DH	Distributed Hunt.
DID	Direct Inward Dialing line – enables external callers to dial directly to an internal number.
DIL	Direct In Line – refers to two-way, standard CO trunk lines that are assigned to a particular extension or hunt group.
DISA	Direct Inward System Access – enables an outside party to access the Strata DK system internal stations or outgoing CO lines without having to go through an operator or automated attendant. An optional security code may be set to prevent unauthorized access to outgoing CO lines for through system calling.
DIU	Data Interface Unit.
DKT	Digital Key Telephone.
DN	Directory Number.
DND	Do Not Disturb – enables a station user to block incoming calls. After DND is activated, internal calls and transferred calls do not ring at the station, and voice announcements do not come through. Off-hook Call Announce is also blocked. The station user can still place outgoing calls.
DNIS	Dialed Number Identification Service – sends the phone number of called party over incoming DID or tie lines to the Strata DK system. This feature is provided by some long distance telephone companies.
DP	Dial Pulse – signals sent to the Central Office which are regular momentary interruptions of direct or alternating current and correspond to the value of the phone digit. It is the same as rotary dialing.
DSS	Direct Station Selection – enables a phone user (as well as a DSS console and ADM user) to call another station with the touch of a flexible feature button.
DTMF	Dual-tone Multi-frequency – pushbutton tone dialing.
DVSU	A subassembly that equips a digital telephone with the capability to receive Speaker Off-hook Call Announce (OCA) calls. DVSU is not required to receive Handset OCA (HS-OCA).
EKT	Electronic Key Telephone.
ESF	Extended Super Frame.

Term	Definition
FIFO	First-In, First-Out.
FOP	Form of Payment – enables the front desk clerk to enter the form of payment (cash, check or credit card) and amount and type of deposit paid using the FOP Tab screen
HDCB	Electronic Door Phone/Lock Control Unit – supports optional door phones (MDFBs) and provides door lock control. A peripheral hardware unit compatible with designated electronic telephone circuits.
HDSS	Electronic Direct Station Selection Console – facilitates the processing of heavy loads of incoming calls. The HDSS console connects only to designated electronic telephone circuits and is associated with electronic telephones.
HESB	External Speaker Box – provides paging speaker and/ or a background music speaker, etc. It is a speaker/amplifier that is configured with the system.
HHEU	Headset/Loud Ringing Bell Interface – connects a headset or external speaker box (HESB) to the phone. It is a subassembly that fits inside a digital telephone or a 6500-series electronic telephone.
ISDN	Integrated Services Digital Network – enables the exchange of digital information at each end of the line without converting analog-to-digital signals. Connection speeds are faster and audio quality is superior. ISDN service requires service subscription from a telco with ISDN equipment.
LATA	Local Access and Transport Area.
LCD	Liquid Crystal Display – displays call information. It is supported by digital and electronic telephones.
LCR	Least Cost Routing.
LSI	Large Scale Integration – related to circuit design technology. Strata DK system printed circuit boards (PCBs) use LSI circuit design.
MDF	Main Distribution Frame – wiring frame usually located in a phone closet.
MDFB	Door Phone Box – two-way speaker box.
MOH	Music-on-Hold – music (customer-supplied) or announcements sent to parties on-hold on CO lines or the intercom.
NFAS	Non-facility Associated Signaling – provides ISDN trunk groups beyond the 23 channels available with a single Primary Rate Interface.
NT-1	ISDN Network Termination device – powers a U-interface ISDN line and enables multiple S/T ISDN devices to connect to it. The NT-1 must be UL-listed (U.S.) or CSA-certified (Canada).
OAI	Open Architecture Interface – enables the computer to command the phone system to answer, delay, switch, hold, etc., calls.
OCA	Off-hook Call Announce. There are two types: Handset OCA and Speaker OCA.
OPS	Off-premises Station.
PBX	Private Branch Exchange – industry-standard term that refers to a telephone switch, usually on-premises, which serves an individual company, and is connected to a public telephone exchange through the Central Office (CO).
PC	Personal Computer.
PCB	Printed Circuit Board.
PDN	Primary Directory Number.
PFT	Power Failure Transfer – automatically switches CO lines directly to a standard single-line telephone and provides emergency service if commercial AC power fails.
PhDN	Phantom Directory Number.
PRI	Primary Rate Interface – trunk interface to the ISDN network, which enables multiple use of channels for DID, tie, FX, WATS, 800, etc. It supports multiple services and dynamic channel allocation. PRI is the larger ISDN interface (via the RPTU) with 23B+D transmission format. Channels are 64-kbps. Also see BRI.
PSAP	Public Safety Answering Point – used for E911 calls.

Glossary

PSTN ~ U Interface

Term	Definition
PSTN	Public Switched Telephone Network
RAM	Random Access Memory – refers to the type of system memory that holds individual system configuration and feature programming. RAM is read/write memory, and can be easily revised in programming.
ROM	Read Only Memory – refers to the type of system memory that holds static software that comprises the mechanics of the features' functions. ROM is only revised by Toshiba software engineers.
RPCI-DI	Personal Computer Interface Unit – enables digital telephones to connect to a PC or ASCII terminal to make data calls to printers, PCs, and other data devices.
S/T Interface	Reference interface points ("S" or "T") of an ISDN network. S/T interfaces are RJ-45, 8-wire connection interfaces for ISDN equipment. An NT-1 is needed to network U-type BRI lines to S/T type interfaces.
SDN	Secondary Directory Number.
SD	Speed Dial – enables dialing of frequently called phone numbers by using a Speed Dial button or codes.
SF	Super Frame.
SLT	Single-line Telephone.
SMDI	Simplified Message Desk Interface – RS-232 link from PIOUS, PIOUS, RSSU, RSIS, or RSIU modular jack connected to a voice mail machine to provide Strata DK voice mail integration.
SMDR	Station Message Detail Reporting.
SMIS	Software Management Information System (SMIS).
SS7	Signaling System 7
TA	Terminal Adapter or ISDN modem that converts PC and other types of protocol into a signal that works with ISDN. Generally, TAs support RJ-11 voice ports and RS-232C or V.35 or V.449 data interfaces.
TAPI	Telephone Application Programming Interface.
TE	Terminal Equipment. This refers to devices using ISDN service (telephones, faxes, computers, etc.). TE1 supports ISDN formats with S/T or U-type interfaces.
TSPI	Telephony Service Provider Interface.
U Interface	A single twisted pair of copper wire on an RJ-11 jack. The wiring is identical to POTS, with different signaling. Only one U-interface device can be attached per line.

Index

A

account codes, 16

ACD

agent

features, 284

ACD, PBX, and non-ACD calls, 285

after call work time, 289

auto answer with zip tone, 290

call pickup, 286

display information, 287

help, 288

log in/log out, 291

unavailable mode, 292

work unit, 293

performance, 336

statistics, 333, 337

status, 334

supervisor features, 294

agent assistance, 295

call monitoring, 299

call pickup, 296

end of shift, 300

log in/log out, 298

MIS access, 317

queue alarm indication, 318

supervisor LCD display, 297

system features, 269

after shift service, 270

automatic disconnect, 271

automatic number identification, 272

inbound call routing, 278

overflow, 279

PBX calls, 281

queue alarm timer, 283

queuing, 282

ACD call center viewer, 325

agent view, 326

alarms, 327

button view format, 328

computer requirements, 325

configurations, 328

display information, 326

main view, 326

multiple supervisor call center viewer

applications, 329

priority text messages, 330

spectrum electronic wall boards, 330

title bar, 327

ACD feature interaction, 319

assistance from busy supervisor, 320

call forwarding, 321

executive/busy override, 322

message and display, 323

station do not disturb, 324

ACD software MIS (SMIS), 332

SMIS displays, 333, 334, 335

SMIS reports, 336, 337, 338, 339, 340, 341, 342

add-on modules

capacities, 2

airlink

(see strata airlink)

alarm sensor, 18

alternate answer point, 19

amplified conference, 20

auto attendant, 21

automatic

busy redial, 121

hold recall, 23

number identification (ANI), 24

release from hold, 25, 29

B

background music, 125
background music interface, 27
base station, 197
billed services
 tab, 350
browse window, 347, 349
busy override, 127

C

call forward, 129, 321
call park, 132
call pickup, 133, 134
call transfer with camp-on, 135
caller ID
 lines (see also BRI, PRI lines)
caller identification, 28
centrex ringing repeat, 31
centrex/PBX compatibility, 30
check-in, 350
check-out, 350
CO line
 capacities, 2
computer telephony integration, 32
conferencing, 35
connection requirements, 347
control status tab, 349
convenient access to screens/functions, 350
cordless digital telephone, 2
credit card calling, 36
customer detail window, 348, 349

D

delayed
 call, 338
 ringing, 37
DID
 lines, 2
digital telephones system capacities, 3
direct inward
 system access, 42
distinctive CO line, 43
DKT2004-CT, 2
DNIS, 38
do not disturb, 142, 143
door lock control, 44
door locks, 2
door phone, 45
door phones, 2

DTMF and dial pulse CO line, 46
DTMF signal time setting, 47

E

E911 enhanced operation, 48
electronic telephone
 system capacities, 3
executive override, 146
external amplified speaker, 50

F

Form of Payment (FOP) tab, 350
function tabs, 349
 billed services, 350
 control/status, 349
Form of Payment (FOP), 350
 messages, 349
 phone calls, 349
 restrict/accommodate, 349

G

ground start lines, 56
group overflow, 338
group traffic monitor, 334
guest directory, 347

H

handset OCA stations, 3
hardware
 configurations hardware, 345
 connections, 347
 server, 345
 workstations, 346
hospitality management information system (HMIS), 343
 applications, 345
 connection requirements, 347
 hardware configurations, 345
 main screen, 347
 user-definable settings, 350
hotline service, 57

I

- incoming call duration, 339
 - Insight DK
 - client (sub-supervisor), 307
 - configurations, 301
 - multiple supervisors, 303, 307
 - single supervisor, 302, 306
 - features, 308, 310
 - Real Time Displays, 310
 - reports, 313
 - system
 - compatibility, 306
 - functionality, 308
 - Insight DK Plus
 - historical reporting, 312
 - real time displays, 312
 - Insight DK Plus, 311
 - inView, 308
 - ISDN
 - basic rate interface (BRI), 58
 - BRI, PRI channel lines, 2
 - primary rate interface (PRI), 61
- ## L
- LCR, 64
 - least cost routing, 64
 - line
 - call pickup groups, 65
 - groups, 66
 - queuing, 67
 - live system programming, 68
 - lost call, 340
- ## M
- main screen, 347, 349
 - browse window, 347
 - convenient access to screens/functions, 350
 - customer detail window, 348
 - function tabs, 349
 - on-screen guest directory, 347
 - memory protection, 69
 - message waiting, 70, 170
 - messages tab, 349
 - multiple
 - DNs, 72
 - FCC registration, 74
 - music on hold, 76

N

- network, 346
- night ringing
 - answer code, 77
 - over external page, 78
- night transfer, 80

O

- OCA
 - handset, 3
 - speaker, 3
- off-hook call announce, 3, 174
- off-premises stations, 3
- on-screen guest directory, 347
- Open Database Connectivity (ODBC), 312

P

- paging, 84, 85, 86, 87
- PC
 - attendant console system capacities, 2
- PC attendant console, 211
 - features
 - answer button, 217
 - answer priority, 218
 - answer prompting, 219
 - attendant conference setup, 220
 - auto day/night mode switching, 221
 - auto dialing, 222
 - busy lamp field, 223
 - call waiting count, 224
 - color CRT display, 225
 - dial "0" for attendant, 226
 - dial outside number for station user, 227
 - direct station selection (DSS), 228
 - directory display and dialing, 229
 - DTMF tone signaling from dial pad, 230
 - emergency calls, 231
 - emergency page, 232
 - employee profile information, 233
 - feature on-line help, 234
 - feature prompting with soft keys, 235
 - flexible programmable buttons, 236
 - headset operation, 237
 - hold button, 238
 - hold timer display, 239
 - incoming call identification, 240
 - incoming call statistics, 241, 242
 - join button, 243
 - keyboard or mouse operation, 244

- load sharing, 245
 - loop hold display, 246
 - message center, 247
 - multi-tasking, 248
 - name or number dialing, 249
 - overflow, 250
 - override, 251
 - park and page, 252
 - position busy, 253
 - release button, 254
 - reminder notes, 255
 - speed dial calling, 257
 - split/switch button, 256
 - three-way calling, 258
 - through dialing, 259
 - transfer direct to voice mail, 260
 - trunk group control, 261
 - volume control, 262
 - windows PC operation, 214
- PDIU-DS, 3
- phone calls tab, 349
- pooled CO lines, 88
- ## R
- reports, 350
- requirements
 - connection, 347
- reservations, 350
- restrict/accommodate tab, 349
- ring mute
 - (see strata airlink features)
- RPCI-DI, 3
- ## S
- screen
 - browse window, 347
 - customer detail window, 348
 - main, 347
- setup, 350
- SMIS
 - supervisor displays, 333
 - system configurations, 333
- speaker
 - OCA stations, 3
- Speed, 209
- speed dial, 103, 190, 257
- standard telephone, 3
- station
 - features, 15
 - alert signal button, 120
 - automatic busy redial, 121
 - automatic callback, 122
 - automatic hold, 123
 - automatic off-hook line selection, 124
 - background music with station
 - control, 125
 - busy override tone, 127
 - busy station transfer/busy station
 - ringing, 128
 - call forward, 129
 - call park orbits, 132
 - call pickup, 133
 - call pickup groups, 134
 - call transfer with camp-on, 135
 - centrex/PBX feature buttons, 136
 - continuous DTMF signal time, 137
 - data buttons, 138
 - dial pulse/DTMF mode change, 144
 - direct station selection (DSS) buttons, 139
 - distinctive LED indicators, 140
 - distinctive station ringing, 141
 - DND override, 143
 - do not disturb (DND), 142
 - exclusive hold, 145
 - executive override, 146
 - flash button, 147
 - handsfree answerback on intercom, 148
 - hearing-aid compatible, 149
- LCD
 - alphanumeric messaging, 150
 - automatic callback number
 - display, 154
 - busy lamp field indication, 154
 - busy station messaging, 151
 - call duration display, 154
 - call forward source/destination
 - display, 155
 - called station messaging, 154
 - calling station messaging, 158
 - calling/called number display, 156
 - clock/calendar display, 159
 - CO line identification, 160
 - dialed number display, 161
 - feature prompting with soft key
 - operation, 162
 - message waiting display, 163
 - recalling station identification, 164
 - remote/group station messaging, 165

- speed dial memo directory dialing, 165
 - station identification, 167
 - timed reminders, 168
 - user name/number display, 169
 - message waiting, 170
 - microphone control buttons, 171
 - modular handset and line cords, 172
 - modular headset interface, 173
 - off-hook call announce (OCA), 174
 - on-hook dialing, 176
 - personal computer interface, 177
 - pooled CO line buttons, 178
 - privacy
 - button, 179
 - override, 180
 - release button, 181
 - private CO lines, 182
 - pushbutton dialing, 183
 - release button, 184
 - release/answer button, 185
 - remote retrieval of held calls, 186
 - repeat last number dialed, 187
 - ringing line preference, 188
 - saved number redial, 189
 - speed dial button, 190
 - timed reminder, 191
 - toll restriction override code revision, 192
 - user programmable feature buttons, 193
- strata airlink
- base station, 197
 - components, 195
 - description, 195
 - FCN feature access, 204
 - features
 - FCN feature access, 204
 - flash button, 205
 - locking the dial pad, 206
 - menu operation, 207
 - ring mute, 208
 - speed dial, 209
 - voice mute, 208
 - volume adjustment, 210
 - handset, 200
 - charger base, 202
 - software manager, 13
 - configuration window, 198
 - desktop toolbar, 198, 199
 - PC hardware and software requirements, 198, 199
- supervisor group, 340
- system
- capacities, 2
 - feature availability, 4
 - features
 - account codes, 16
 - alarm sensor, 18
 - alternate answer, 19
 - amplified conference, 20
 - auto attendant, 21
 - automatic hold recall, 23
 - automatic number identification, 24
 - automatic release from hold, 25, 29
 - background music interface, 27
 - caller identification, 28
 - centrex ringing repeat, 31
 - centrex/PBX compatibility, 30
 - computer telephony integration, 32
 - conferencing, 35
 - credit card calling, 36
 - delayed ringing, 37
 - dialed number identification service, 38
 - direct inward system access, 42
 - distinctive CO line/internal ringing, 43
 - door lock control, 44
 - door phone, 45
 - DTMF, 46
 - DTMF signal time setting, 47
 - E911 enhanced operation, 48
 - external amplified speaker, 50
 - flexible
 - button assignment, 51
 - intercom/DN numbering, 53
 - line ringing assignment, 54
 - slot assignment, 55
 - ground start lines, 56
 - hotline service, 57
 - ISDN
 - basic rate interface, 58
 - primary rate interface, 61
 - least cost routing, 64
 - line call pickup groups, 65
 - line groups, 66
 - line queuing, 67
 - live system programming, 68
 - memory protection, 69
 - message waiting, 70
 - multiple DN's, 72
 - multiple FCC registration, 74

- multiple simultaneous handsfree intercom paths, 75
- music on hold interface, 76
- night ringing answer code, 77
- night ringing over external page, 78
- night ringing over selected page zone, 79
- night transfer, 80
- non-blocking dialing, 81
- off-premises station, 82
- outgoing call restriction, 83
- paging
 - all call voice page, 84
 - external page interface, 85
 - external zone paging, 86
 - group paging, 87
- power failure transfer, 89
- privacy/non-privacy option, 90
- relay service, 91
- remote administration/maintenance, 92
- reserve power battery backup interface, 93
- speed dial, 103
- station hunting, 96
- station message detail recording, 98
- station relocation, 101
- system programming through station, 102
- T1 interface, 113
- tandem CO line connection (trunk-to-trunk), 103
- tenant service, 105
- tie lines, 106
- toll restriction, 107
- toll restriction override codes, 109
- toll restriction override using system speed dial, 110
- transfer privacy, 111
- traveling class of service, 112
- voice mail interface, 114
- voice or tone signaling, 117
- wall or table mounting, 118

migration, 2

overview, 1

status, 335, 341

tools

- dkadmin, 10
- dkbackup, 11
- dkquote, 10
- keyprint 2000, 13
- strata airlink wireless manager, 13
- stratacontrol, 11

system components, 197

T

- T1/DS-1
 - lines, 2
- telephones
 - DKT, 3
 - EKT, 3
- tie lines, 2
- toll restriction, 109, 110, 192

U

- universal slots, 2

V

- voice mute
 - (see strata airlink features)

W

- window
 - browse, 347
 - customer detail, 348
- wireless
 - (see strata airlink)
- work unit, 342